



Alexander Putney



Φ is the mathematical symbol for *phi*, a transcendental number: 1.6180339887498... This universal constant is reflected in all of nature's patterns. Sacred art and architecture all over the world apply it as the golden ratio, 1:1.618 or 2:3:5, monumentally seen in the design of the Great Pyramid corresponding to the angular inclination of infrasound standing waves.

Alexander Putney's Magnetic Resonance maps define the phi-ordered global distribution pattern of the world's pyramids as a precise expression of the quadratic function [$z_{n+1} = z_n^2$]. This nonlinear fractal encodes Earth's deep infrasound resonance as symbolized by the Sanskrit mandala, a *square within a circle*. Representing the sacred vital force of consciousness, this mandala is found in Egyptian temples as the Rose Cross, in megalithic stone circles as the Celtic Cross, in Buddhist temples as the Kalachakra or 'Wheel of Time' and in Mayan temples as a symbol of Hunab K'u, the Universal Creator.

The nonlinear alignment of the world's sacred sites to the Great Pyramid reveals their collective function as an infrasound wireless network synchronized to the 1.45 Hz frequency of the human heartbeat. The Sanskrit *third-eye* represents kundalini activation of the pineal gland –the *ajna* chakra at the center of the brain– containing calcite microcrystals that transduce the infrasound resonance of the calcite pyramid stones.

This profound holographic knowledge is encoded in ancient Altantean quantum maps inlaid with calcite geometric patterns that fluoresce under ultraviolet light, displaying standing wave resonance at subatomic, molecular and planetary scales. Sacred water springs flowing from ancient Sanskrit sites crystallize the body and generate HHO plasma in the pyramid chambers, where waterbirthing practices affect DNA enhancement, endowing the advanced states of synesthetic consciousness to which indigenous wisdom-keepers have remained keenly attuned.



Alexander R. Putney

www.human-resonance.org
www.resonanciahumana.org
www.resonanceoflife.org

© 2008 Alexander R. Putney

For all of the radiant beings who guide humanity
toward the creation of a lasting peace on Earth,
with her transformation into a heavenly planet
under the purifying red light of the solar twins.

*Tláloc, God of Celestial Water, god of the vapor that rises,
from the earth warmed by the sun after the rains, god of the mist that ascends from the valleys at dawn...
Tláloc is the return of vapor that strains to rise, is the return of time that strains to remember.*

*Tláloc, God of the Fight Against the Current,
with whose aid the hero battles against the torrent toward his own origin and beginning,
towards the wings of his soul, the wings that Tláloc hides in the hero's past...*

*But in their hearts and in their semen, each man has his own coatl, his own serpent,
the energy of Tonatiuh, the power of the sun itself.*

*And in this serpent sleeps consciousness,
in this serpent is hidden his divinity.
From this serpent his wings will grow.*

(Pyramid of Fire Codex, pages 9-10)

1 Atacama Silence	1 – 18
2 Psychoacoustics	19 – 36
3 Biorhythmic Pyramids	37 – 58
4 Magnetic Resonance	59 – 92
5 Sanskrit Aztlan	93 – 114
6 Ultraviolet Caves of La Maná	115 – 140
7 Celestial Water	141 – 162

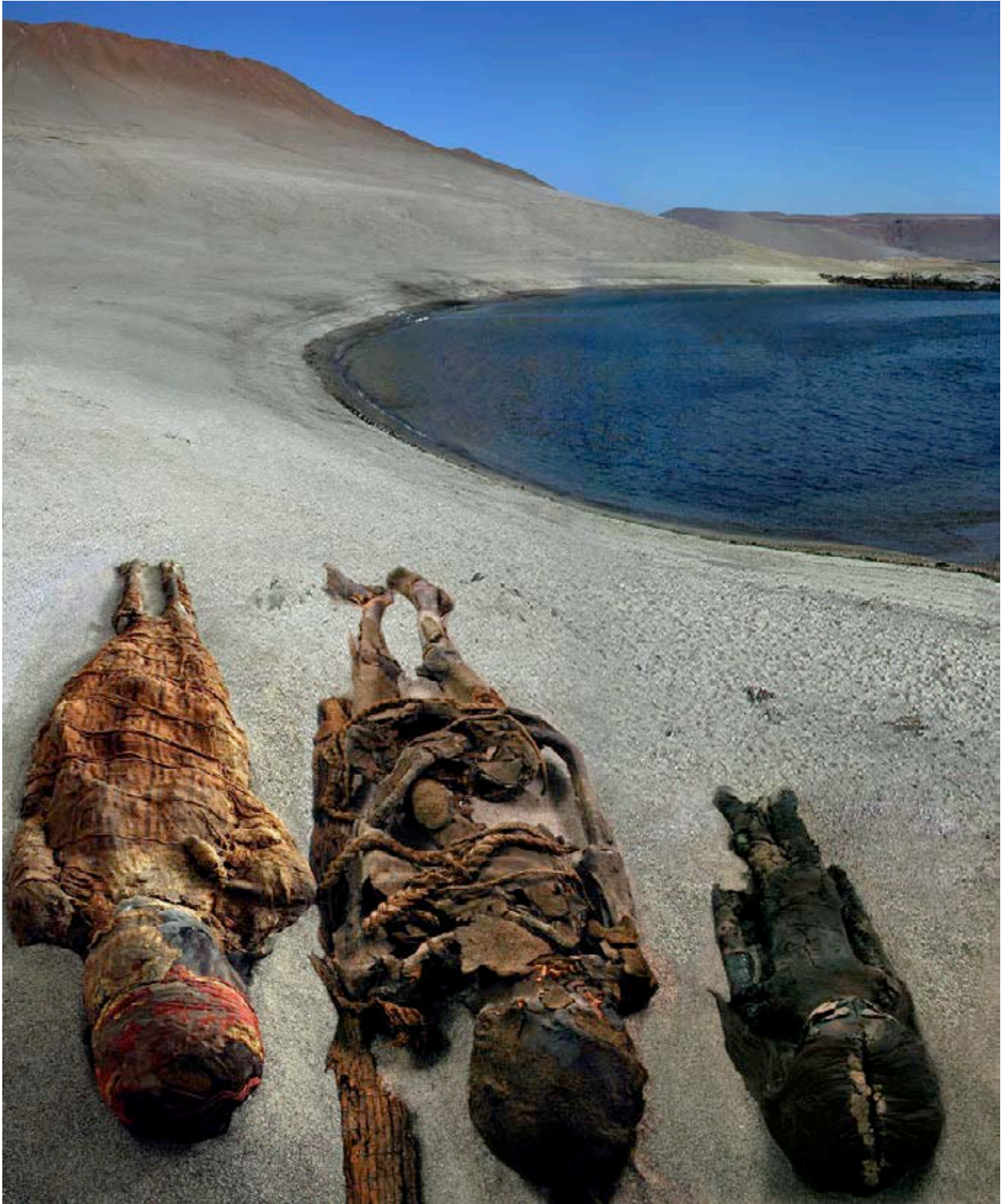

1

Atacama Silence

Atacama Silence



1.1. Clay masks of a mummified stillborn infant (center) and two mummified fetuses with mouths open in song

The winds of change wipe away most traces of the deep past; waters mix and entropy engulfs matter. What modern humanity knows about its own origins and the rhythms of the cosmos in which his consciousness germinates has been deciphered from investigation of the layered strata of the Earth. The driest deserts of this planet preserve the remains of the movements of humans from water source to water source, and nowhere is this process more extreme than in the Atacama Desert, where lack of rainfall has left the terrestrial surface virtually unchanged for many thousands of years. Mists are all that ever touch the Atacama sands, eroded only by seasonal flush of rivers flowing to the Pacific Ocean from the Andean altiplano above.

Driest of all the Earth's deserts, the Atacama has preserved a coherent record of the region's ancient inhabitants and migrating peoples who harvested the ocean bounty to survive prolonged heat waves. Vast waves of migrations from Asia were undertaken by technically advanced cultures that fulfilled all of their needs by exploiting the ocean. The Chinchorro were a Paleolithic fisherfolk who inhabited a 400-mile stretch of South American coast from Ilo in southern Peru to Antofagasta in northern Chile more than 7,000 years ago. A holistic picture of their mummification tradition has been assembled by Chinchorro researcher B. Arriaza, an associate professor of anthropology at the University of Nevada, Las Vegas and an adjunct researcher at the Universidad de Tarapacá in Arica, Chile:

Sometime around the beginning of the fifth millennium B.C. the Chinchorro began mummifying their dead--eviscerating the corpses and defleshing the bones. The skeleton would be reassembled, reinforced with sticks, and internal organs would be replaced with clay, camelid fibers, and dried plants, while muscles would be re-created with thin bundles of wild reeds and sea grasses. The body would then be "reupholstered" with the skin of the deceased, which would have been carefully removed and set aside... The entire body was then covered with an ash paste and finished with a coat of shiny black manganese or, in later years, brilliant red ochre. Many of the mummies had clay masks with carefully modeled facial features and clay sexual organs, and wore elaborate clay helmets or wigs of human hair some two feet in length. So far some 282 Chinchorro "mummies" have been found at cemeteries such as El Morro, Camarones Cove, and Patillos. Of these, 149 were created by Chinchorro artisan-morticians; the rest were naturally desiccated by in the hot, dry sand of the Atacama Desert. The earliest known mummy... dates to ca. 5,050 B.C. During the next 3,500 years Chinchorro mummification evolved through three distinct styles--black, red, and mud-coated--before the practice died out sometime in the first century B.C.¹



- 1.2. Mummified Chinchorro juveniles: a hand detail (left) and singing child wrapped and masked in clay (right)
- 1.3. (Opposite) Mummified Chinchorro woman with her painted body remodeled and her face masked with clay
- 1.4. (Page 5) Young mummified girl with long, well-preserved hair and a patterned facemask with circles in rows

The Chinchorro cultural practice of mummification provided a vital link between this world and the next as a means of honoring departed loved-ones, yet furthermore provides a record of their spiritual beliefs and way of life that informs modern researchers of the great antiquity and oneness of human spiritual technology. Ancient cultural traditions still maintained today in Asia have left unmistakable traces all over the world, and along the Andean coastlines in particular. The extensive skeletal remains of the Chinchorro people confirm their genetic origins among the Jomon people of Pacific Asia, most closely related today to the Ainu indigenous people of modern Japan. Ainu skin tones are pale, yet otherwise their physical characteristics show a strong resemblance to the aboriginal populations of Australia. Genetic studies confirm a broad blending of the Jomon bloodlines into today's Andean population.

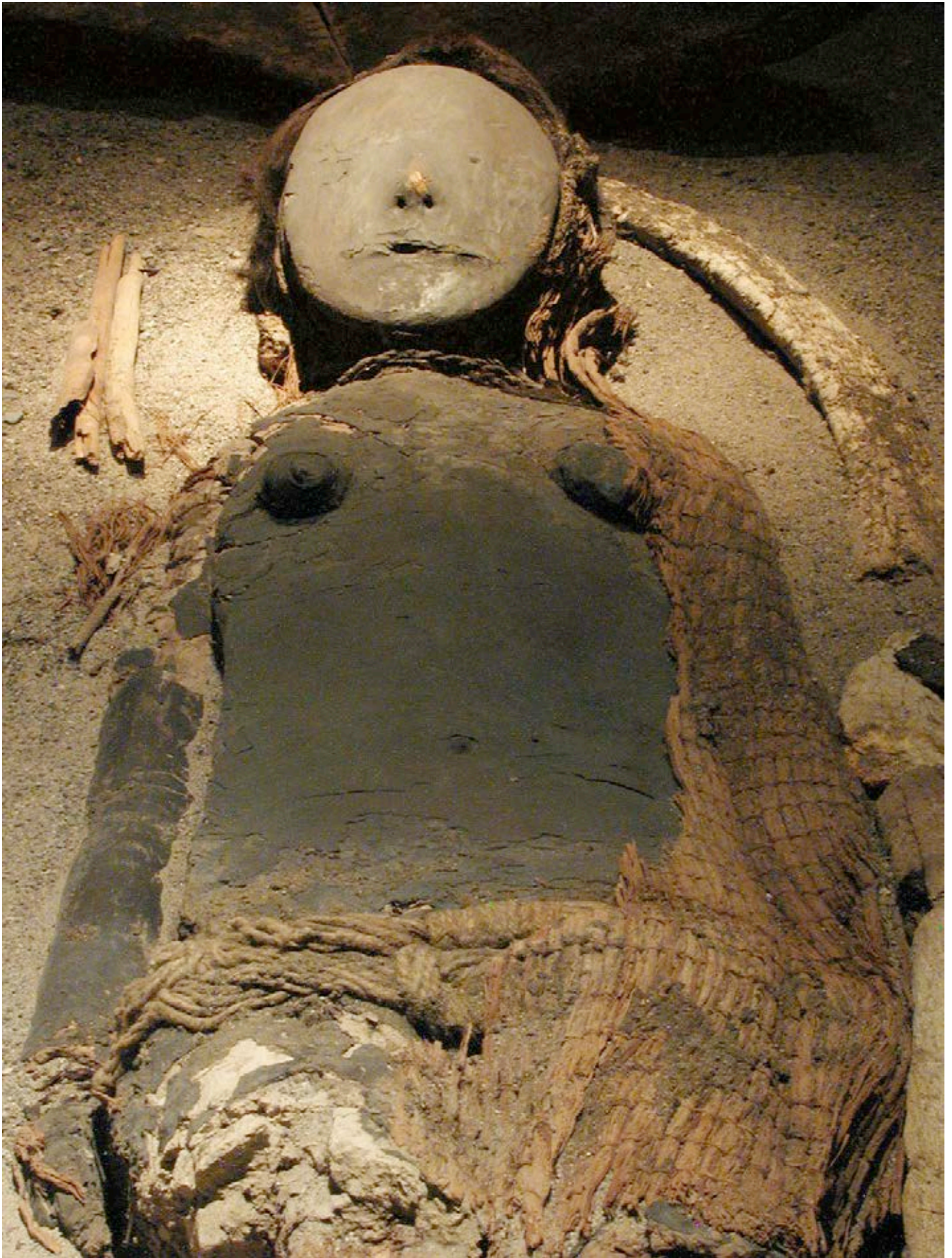







1.5. (Page 6) Mummified Chinchorro skull from the Camarones Cove site with a thin clay mask still partially preserved
 1.6. Bi-frequency stone whistles carved by the Chinchorro culture discovered at the Chinchorro beach habitation site

My own investigations in the Atacama Desert produced dozens of surprising finds of lithic tools, revealing previously unknown cultural practices of the ancient Chinchorro inhabitants whose artificial mummies are among the oldest known. I spent a year of study in 2001-02, provided by a Brandeis-Hayes Traveling Fellowship, drawing and photographing the large collection of Chinchorro mummies at the Museo Azapa, in the Azapa River valley outside the small northern Chilean city of Arica. Complementing my museum studies, I spent countless hours combing the shorelines for several miles outside of Arica, overturning stone after stone in search of ancient tools –from the long, white-sand beaches of the north side to the volcanic crags and magnificent windblown caves beyond Corazones beach stretching to the south.

Chinchorro beach near central Arica was a habitation site regularly used for millennia, where the seasonal flows of the Azapa River meet the brine of the sea, silting the bay. My many months of beachcombing produced several bi-frequency stone whistles from the rock shoals near El Morro (1.6). Sonographic analyses of 11 stone whistles revealed an acoustic range of 2740-4000 Hz easily capable of producing painfully deafening amplitudes that can be heard over great distances despite the roaring surf. The smallest whistle I collected in Arica was carved to make use of a natural quartz-lined cavity as a resonator, the hole having been modified to produce a perfect F natural at 2740 Hz (1.6, bottom right). One basalt whistle is formed as an elongated skull with the resonator at the top of the head (1.6, left), while another whistle of granite has been carved with two adjacent resonators to be played simultaneously (1.6, bottom center). The bi-frequency tonal output of these Chinchorro whistles is an advanced lithic application of *psychoacoustic technology* for the enhancement of consciousness that was perfected by the many later ceramic traditions of the Andes, a vast topic to be thoroughly investigated in the following chapters. This set of fascinating bi-tonal instruments was among my collection of Chinchorro stone carvings loaned to the 'Unsolved Mysteries Exhibition' produced by Austrian Klaus Dona.² The traveling exhibition was hosted from November '04 – March '05 at Mystery Park in Interlaken, Switzerland and at the Zentrum Kreuzburg in Berlin, Germany from May '05 – September '05.



1.7. Walrus head stone carving from the Aleutian Islands in the collection of the American Museum of Natural History

My finds at Chinchorro Beach included medicine stone carvings in the form of the heads of spirit animals comparable to those made by Native American indigenous healers. One example of this type from the Aleutian Islands appears to be a walrus head stone carving (1.7). Of a set of three stones I collected at Chinchorro beach (1.8), the largest stone is a blunt axe, the size and form of a baby seal head, and the two smaller stones are circumscribed to tie and wind fishing line, carved in the shape of a fish head and a seal.

1.8. Chinchorro stone carvings formed as the head of a seal pup (left), a fish head (center) and the torso of a seal (right)





1.9. Medicine stone carving in the form and size of a seal head, with symmetrical, deeply set eyes, nostrils and mouth

For several months I poured over the wide shoals of rounded river stones that filled only this portion of beach junction, collecting hammer stones, harpoon heads, fishing tools, hand axes, and heavy blunt stone axes used for seal hunting, shaped in the image of the prey animal itself. The seal's head is recreated in stone carvings as a symbol of great respect for the animal spirit that nourishes human beings by relinquishing its physical body in the hunt. While shellfish collection and fishing comprised a large portion of the Chinchorro diet, seal meat was a staple. Pathologists investigating these most ancient mummified bodies at the San Miguel de Azapa Museum outside Arica, Chile have noted the pervasive presence of intestinal parasites *Diphyllobothriasis pacificum*³ ingested as ova in the seal flesh, and an abundance of external auditory exostoses –the bony growths of ear infections resulting from extensive ocean swimming.⁴ Parasitic infection was the most common Chinchorro ailment, one dealt with often by their tribal healers. Quite surprisingly, *reflexology techniques* for the treatment of parasite infections have been artistically represented in the Chinchorro stoneworks.

The first large stone carving I overturned would eventually shed light on the healing techniques that mitigate the relationship between the hunter and the hunted. The carved features were unmistakable even from a distance; I picked up the life-size carving of the head of a seal (1.9). I washed off the white dust covering to expose a dotted green-brown stone with deeply drilled round inch-wide eyes, fine nostrils and snout. A series of dots lay in the concave cup-shape of the forehead, likely used to mix ochre and manganese pigments. After several days of handling the stone I became curious as to the asymmetry of the back of the seal portrait head, becoming convinced that all faces of this stone had been formed with purpose, one I did not yet understand. Then, one day the subtle pattern hit me and I placed my right foot on the stone, understanding the intriguing asymmetry caused by the angle of the toes being represented on the stone's bottom side. I noted the location of several dots carved into the



1.10. Bottom face of the seal head medicine stone presenting the form and size of an human foot –with dot patterns

stone sole and searched for a contemporary map of pressure points for comparison. I was stunned to find my suspicions completely confirmed – I had found an ancient acupressure map indicating points in concurrence with modern reflexology as corresponding to the lower intestines, where seal parasites reside. The complete message of the stonework came into focus: human dependence on the seal and the remediation of pain from parasitic infection through acupressure, so precisely indicated in dual form.

The discovery of the seal head stone drove me to the shoreline in search of clues, and the finds occurred continuously. The large group of bi-frequency whistles was found after the seal head carving had forced me to look all the more closely at what lay beneath my feet in shifting shoals of stones. Having a great respect for the Chinchorro dead I avoided the looted burial grounds and was excited to collect their lithic instruments from the tidal beaches of their ancient encampments and hunting grounds.





1.11. (Opposite) Artificially mummified Chinchorro women, child and fetus from Camarones Cove, northern Chile
 1.12. Helical DNA structure perfectly described in the textiles of the Chiribaya (left) and Chancay cultures (right)

Textile patterns from the Andes are replete with images of zigzags, sine waves and helices –complex and accurate depictions of three-dimensional molecular structures only recently discovered by modern scientists. The sanctity of the double helix is well noted by Amazonian cultures known for their use of Ayahuasca, a psychotropic mixture based on a helically growing vine that is used to engage in the spirit world. To interpret these symbolic images as abstractions is to deny the obvious and overwhelming demonstration of the advanced ancient knowledge of the seat of the soul within each living cell, now referred to so clinically as DNA, deoxyribonucleic acid. The adeptly woven helical representations are stunningly familiar to us, their illusion of depth entrancing. The double serpent motif is repeatedly represented in the textiles of the Chiribaya mummies, found buried near the coastal town of Ilo, Peru, and now preserved at the Museo Algarrobal through the work of S. Guillen and the Centro Mallqui.

The DNA helix is three-dimensionally described on a woven bag (1.12, left) in three vertical bands amid a checkerboard pattern suggestive of information encoding. A Chancay folding cloth (1.12, right) depicts the base pairing of DNA as a cross between four boxes, in four vertical columns that are broken in the center by an irregular banding surprisingly reminiscent of the banding made by modern analyses of DNA using Agarose Gel Electrophoresis. A Chiribaya folding cloth from Ilo, Peru (1.13, left) depicts two-headed DNA serpents in mirrored vertical rows, each serpent with four dots paired with lines, like the four base nucleotide components Adenine, Guanine, Cytosine and Thymine. A large ceremonial outfit from the Tiwanaku culture (1.13, right) depicts mirror-image twins holding serpent staffs and severed heads, dramatic symbols addressed later in detail. Above each twin is a set of four building blocks depicted in three-dimensional depth, such that the interlocking blocks combine in two pairs, just as Adenine only pairs with Guanine and Cytosine exclusively with Thymine. The garment actually contains a detailed technical image of nucleotide base pairing possibilities in the context of the helical metaphor of serpent twins! Constant shifting in the structure of DNA have been reported in recent studies of induced emotional states that become instantly expressed in the winding or unwinding of the helix itself.⁵ Peaceful emotional states promote DNA relaxation while fear promotes constriction of DNA by winding up. Calm, unwound DNA strands form straight ladders, depicted as snake staffs held by the twins of the Tiwanaku.



1.13. Chiribaya weaving with two-headed serpents (left) and a Tiwanaku textile with twins holding serpent staffs

The complex woven designs of ancient Andean cultures provide the key to penetrating their deep understanding of the invisible energy interactions that endow consciousness. The ancient awareness of the DNA blueprint informs the cultural practice of preservation of the DNA records in the soft tissues of the dead, as well as the practice of cranial augmentation. These textiles were themselves preserved as possessions of the dead accompanying the mummified flesh and bones, their own DNA also preserved by the processes employed. The presence of the preserved ancient DNA and the repeated woven depictions of DNA together directly asserts the purpose of ancient Andean mummification to have been the preservation of DNA and elongated crania –as evidence of consciousness enhancement achieved.



1.14. Chiribaya head cradle for skull augmentation

Once considered abstract imagery, these artworks must now be recognized as encoding the structure of sound waves and the helical DNA receptors within all cells. The Chinchorro culture's whistles were likely played in groups of complementary tones, perhaps being tuned within a narrow range in specific social groups. The nomadic lifestyle of the sea-faring Chinchorro is reflected in their simple durable psychoacoustic whistles, stone implements also likely used practically in food preparation and ochre grinding. Their boats were constructed from tied and woven reed bundles, simply designed for the harvesting of ocean fish species. The early mariners' boats have not been preserved, yet the Andean tied-reed canoe design likely carried these migrants from Asia. In fact, genetic studies of the Chinchorro mummies have shown their ancestral origin to be thousands of miles away from their burial sites in the sands of the Atacama. The presence of Chagas disease in the Chinchorro mummies and in modern populations of the Andes and Japan⁶ provides a genetic link revealing the distant origin of these ancient pacific coastal migrants and their advanced knowledge of the DNA molecule.



1.15. Exquisite Chiribaya example of the advanced biotechnology of cranial augmentation by sound wave focusing

Stone head cradles (1.14) found buried with the mummified remains of individuals with elongated crania have been mistaken for similar food grinding bowls, yet can now be fully understood as part of the sound wave focusing system responsible for cranial augmentation. Evidence supporting this new hypothesis is later discussed in the context of finds from La Maná, Ecuador, where an identically formed granite head cradle (6.6, page 121) was discovered among many other advanced bi-frequency instruments. A most unusual Chiribaya skull (1.15) displays very odd features –large ocular cavities, protrusions of the



1.16. Delicately preserved head of a mummified Cañamo woman with hair that has been finely braided and wrapped

zygomatic bones at the temples and an extremely long nose with an extra nasal bone. This combination of highly unusual features is also seen in 9' tall giants from cave sites in Mexico and the United States (5.5 and 5.6, pages 99-100). The cranial characteristics and enormous size of these individuals suggest they belong to a separate species of humanoid whose origins remain unknown, having been the subject of the myriad legends of giants from around the world and depicted in giant statuary on Easter Island.

The general human populations of the Atacama show Asian origins. Geologist S. Gonzalez studied the collections of Mexico's National Museum of Anthropology and presented findings regarding a narrow or dilocephalic skull with radiocarbon dates of 13,000bp.⁷ Craniometrical measurements strongly suggest the Atacama skulls are not reflective of the native North American lineage, but of the ancient Jomon of Japan (1.16). Gonzalez believes the first Americans came from Japan by boat, noting that the long, narrow skull shape shows that the earliest Americans were ancestors of the Ainu people of Japan, a small remnant of the genetic group. The bones of the Pericue people of Baja California, exterminated in the 18th century, displayed the same dilocephalic features and desert habitat as the Chinchorro, having preserved their ancient way of life until recently on the Baja peninsula. The Pericue culture's use of flat throwing sticks recollects their aboriginal relatives' use of boomerangs far across the Pacific Ocean on the Australian continent. The Jomon coastal migration hypothesis is well supported by the craniometrical studies of Brace et al.⁸ In a genetic study done by Ruiz-Linares et al.,⁹ Y-chromosome patterns confirmed that immigration to the Americas occurred in at least two waves, beginning about 14,000 years ago.



16 1.17. Naturally mummified Chinchorro woman with a full head of hair blown by the desert wind (left) and a Chinchorro man wrapped in braided ropes



1.18. Volcanic ash-covered tools: a double whistle formed as an animal head (left), and another as a bird's head (right)

Their review of the genetic diffusion patterns suggested that all South Americans seemed to stem from the same wave of migration. The growing pattern being observed includes two major migrations of East Asian Jomon boat-builders, who could maintain their piscatorial lifestyle along major river systems to penetrate throughout the Americas along every coastline and major riverway. Subsequent waves of migration of Asiatic peoples, including Siberian and Mongolian, created the diversity seen in North American indigenous populations and the Athabascan and Aleutian language groups, while the Jomon lineage and dilocephalic characteristics remained predominant among indigenous South Americans.



1.19. Possible acuopressure tool in the form of a hawk

It then seems likely that Neolithic Jomon culture of Japan is the source of the advanced spiritual traditions developed in the Americas, a people known for very early ceramics and weaving, who left incredible building foundations that once supported wooden architecture in excess of 50' in height as at Sannai Maruyama.¹⁰ Beachcombers along the shores of Japan have noted the presence of various stone whistles, notably seen in the Iwabue collection,¹¹ although only a few bear the definitive traces of shaping by human hands. Being hunters and gatherers, the Jomon migrants collected raw materials for the carving and tuning of whistles from resonant crystalline stones with natural cavities that would require less labor to create the finished whistle. This appears to be true of a powerful quartz whistle with a tiny resonator cavity that produces a clear F natural, discovered by C. Morrison at a well-known ancient habitation site in Tiburon, California.¹²

Among my own collections from the San Francisco Bay coastline near Tiburon are three-dozen stone whistles in a wide variety of resonant stones including sandstone, quartz, granite, basalt, diorite and greenstone. Further finds in Oregon's Colombia River vicinity have included stone whistles from an ancient riverbed, all of which have been covered by the unmistakable residue from the massive Mt. Mazama eruption of about 7,000 years ago (1.18), that left an ash layer over hundreds of miles north of what is now Crater Lake, Oregon. The widespread presence of both natural and artificially created whistling stones in the Pacific coastal context suggests the continuity of an advanced acoustic tradition originally diffused from Japan to imbue the diverse spiritual practices of the Americas.

References

- ¹ Arriaza BT, Hapke RA, Standen VG (1999) *'Making the Dead Beautiful: Mummification as Art'* Archeological Institute of America, online · <http://www.archaeology.org/online/features/chinchorro/>
- ² Dona K, Habek R (2001) *'Unsolved Mysteries'* online · <http://unsolved-mysteries.org/rundgang2eng/rg2eng.htm>
- ³ Reinhard K, Urban O (2003) *'Diagnosing Ancient Diphyllbothriasis from Chinchorro Mummies'* *Memorial Institute Oswaldo Cruz* 98 (Suppl 1), pp. 191-193
- ⁴ Standen VG, Arriaza BT, Santoro CM (1997) *'External Auditory Exostosis in Prehistoric Chilean Populations: a Test of the Cold Water Hypothesis'* *American Journal of Physical Anthropology* 103, pp. 119-29
- ⁵ McCraty R, Atkinson M, and Tomasino D (2003) *'Modulation of DNA Conformation by Heart-focused Intention'* Institute of HeartMath Publication 03-008
- ⁶ Hong-Chuan L, Toshinobu F, Hong L, Shinji Y, Shuro S, Cartier L, Nunez L, Munoz I, Satoshi H, Kazuo T (1999) *'The Presence of Ancient Human T-cell Lymphotropic Virus Type I Provirus DNA in an Andean Mummy'* *Nature Medicine* 5, pp. 1428-1432
- ⁷ González-José R, Neves WA, Lahr MM, González S, Pucciarelli HM, Hernández M, Correal G (2005) *'Late Pleistocene/Holocene Cranial Facial Morphology in Mesoamerican Paleoindians: Implications for the Peopling of the New World'* *American Journal of Physical Anthropology* 128, pp. 772-780
- ⁸ Brace CL, Nelson AR, Seguchi N, Oe H, Sering L, Qifeng P, Yongyi L, and Tumen D (2001) *'Old World Sources of the First New World Human Inhabitants: A Comparative Craniofacial View'* *Proceedings of the National Academy of Sciences* 98, pp. 10017-10022
- ⁹ Bortolini M-C, Salzano FM, Thomas MG, Stuart S, Nasanen SPK, Bau CHD, Hutz MH, Zulay L, Petzl-Erler ML, Tsuneto LT, Hill K, Hurtado AM, Castro-de-Guerra D, Torres MM, Groot H, Michalski R, Nymadawa P, Bedoya G, Bradman N, Labuda D, and Ruiz-Linares A (2003) *'Y-Chromosome Evidence for Differing Ancient Demographic Histories in the Americas'* *American Journal of Human Genetics* 73, pp. 524-539
- ¹⁰ Hudson M (1996) *'Sannai Maruyama: A New View of Prehistoric Japan'* *Asia-Pacific Magazine* 2, pp. 47-48
- ¹¹ Iwabue S (2004) *'Stone whistles made by nature'* online · <http://plaza.across.or.jp/~iwabue/>
- ¹² Morrison C, Velasquez R (2004) *'Tiburón Whistle'* online · <http://www.geocities.com/rvelaz.geo/tiburon/tiburon.html>



2

Psychoacoustics

Psychoacoustics



2.1. Lembayaque double-chambered vessel with waves

The terraced gardens and once thatched-roofed buildings of ancient Machu Picchu lay open to the sun whose rays cut across the megalithic solar clock at its pinnacle, *the Intiwatana*. Far below this timeless keep, ears become filled with the tumbling energy of the Urubamba River tearing through the sacred valley of the Incas. Resplendent hummingbirds dart and pause in their nectar collection, keeping appointments with those jungle flowers whose forms accommodate only their curved, needle-like beaks. Deeper under the cover of leafy canopy the hummingbirds can be heard more clearly than seen. A keen listener can identify the flight paths of seven busy feeders woven through the surrounding airspace imbuing consciousness. The low purring of wing beats aligns thought patterns to the secrets of the Incas, for whom the darting hummingbird was a mystical creature of enchanting divine influence.

Inca weavers and ceramic artists decorated their complex masterworks with images of this fleeting agent of consciousness, and the humming of its flight inspired and symbolized a spiritual technology of sound revealing unfathomed depths of ancient human knowledge. In direct opposition to all of the arrogant claims of a dissonant modern technological world, the ancient sacred science of consciousness is one of *synchronized acoustic resonance with our mother Earth –'la pachamama.'*



2.2. The interaction of two offset frequencies phasing in and out of synchrony to create an inaudible beat frequency

The Inca, Chimu, Lembayaque and virtually all other Andean cultures crafted a multitude of ceramic whistling vessels whose simple design belies a penetrating sophistication. The vessels were blown into through a tube, and half-filled with water to regulate air pressure into a second chamber with whistles poised at exit vents, producing paired tones that engage human consciousness in astounding ways. These instruments produce a sensation of internal synchronization often described as an inner wind or resonance, having no reality independent of the perceiver. The enigmatic effect the vessels produce has been called a 'phantom tone' created by the hearing apparatus itself, having an ethereal existence within consciousness, as observed by German experimenter H.V. Dove in 1839. The tendency of the human mind to entrainment was first described as electroencephalographic (EEG) frequency-following response.¹ The whistling vessels are described as '*psychoacoustic*' for the resulting entrainment of human brainwave patterns into an alpha frequency range of 13-8 cycles per second (Hz) and below.

This class of instruments produces two slightly offset tones that interact to produce a third tone, like the flutter of wings, perceptible only to the listener. This elusive third tone is referred to as a difference tone, or beat frequency, as it occurs when the two offset frequencies phase in and out of synchrony (2.2). The effect is most powerfully experienced with each ear receiving separate distinct tones; a *binaural* beat is perceived that originates in the brainstem's superior olivary nucleus, the site of contralateral integration

of auditory input.² Human brainwave patterns of waking or beta states generally fluctuate within the range of 14–25 Hz, while alpha wave patterns are observed during tranquil, meditative, or introspective states of consciousness where creativity blossoms.³ As the brain is incessantly entrained by the acoustic and luminal environment, self-induced alpha states can be developed only in quiet spaces. Psychoacoustic whistles create an alpha wave environment that immediately brings the frequency of the human mind into its most propitious state,⁴ while the whistler themselves receives the strongest binaural experience. Although many double-tone combinations do produce beat frequencies in the human brain, precision tuning can be achieved using harmonic frequencies, so the audible tones are multiples of the desired beat frequency (e.g. 7 Hz beat = 77 Hz, 84 Hz audible). Induced low-level beta states have been demonstrated to improve human memory.⁵ The fundamental frequency of the Earth's vibration, known as Schumann Resonance, fluctuates irregularly between 7.3 and 8 Hz on the alpha/theta brainwave border, capable of entraining the human brainwave pattern only in the absence of industrial acoustic pollution.

The rediscovery of the physiological effects of this ancient class of instruments occurred through the research of S. Garrett and D. Statnekov.⁶ The researchers studied the frequency variation in 73 whistling ceramics from 9 distinct Andean cultures, spanning some 2,000 years. The tuning of instruments was determined to be culture-specific, as all of the instruments of any one culture were tuned together into precise frequency ranges. A general trend observed was a steady increase in the chosen frequency over time, the earlier Vicus, Moche and Huari near 1320 Hz, the Recuay near 2000 Hz and the later Chancay, Chimu and Inca bottles near 2670 Hz. The fact that all cultures of the region employed this instrument, each with its own specific frequency range, attests in itself to the significance of the group frequency identity. Further experiments in playing several instruments from one culture showed an increased effectiveness, often inducing extraordinary personal experiences and group reflections. The prime number of instruments in any group is said to be 7, sacred to Andean belief. The achievement of unified group consciousness may also be reflected in deeper ways in the societies who shared in their use. The collective result of this kind of societal tuning is that *one brainwave pattern is simultaneously shared by all*. Enhanced states of telepathic and remote viewing capability have been achieved by modern research, revealing coherent thought transfer can occur between individuals during induced brainwave synchrony.⁷ Ancient neural synchrony technologies are indeed the prime key to enhancing human consciousness, opening another dimension of awareness and communication.



2.3. Moche vessel with nested semicircles

Often used in conjunction with psychotropic plants, breathing and fasting methods, the central role of consciousness synchronization in the spiritual life of ancient Andean cultures is made remarkably clear by the staggering numbers of instruments produced and entombed with the mummified practitioners. This profound ancient psychoacoustic technology remains largely forgotten, as deep a secret as the one emanating from within every living cell. The experience of inner resonance induced by the difference tones is felt by many to be profoundly transformative in nature, in that it increases the coherence of neural function by synchronizing the left and right hemispheres of the brain. The full potential of this unified state of modified neural functioning is not known, but has been shown to allow increased visual and creative ability.⁸ Hemispheric synchrony is the concept behind the modern entrainment research of R. Monroe, who has produced binaural recordings called Hemi-Synch.⁹ Andean textile and masonry patterns present diverse variations of nested semicircles (2.3) that are quite clearly seen as symbols for the hemispheric synchronization of the brain. The acoustic wave environment has also been shown to effect neurochemical balances, just as techniques using wave induction derived by Patterson and Capel, reported in 1980.¹⁰



2.4. Inca psychoacoustic portrait vessel with double bird imagery, double waveforms and arching waves shown in red



2.5. Two Inca whistles formed as large spiral-shelled snails, glaze-painted with orange and red zigzag waveforms

The acoustic practices of ancient Andean society increased neural coherence within both the individual and group consciousness by synchronization, affecting a shift in the functioning of the entire brain. Neurochemical levels provide insight into the ‘subtle’ effects of the acoustic frequency environment upon emotional states and brainwave patterns. The imbalance of the acoustic wave environment created by ‘industrial’ man using ultra-high frequency wireless and cellular technologies has profoundly detrimental effects on consciousness, and is a major contributor to cancer, so commonly observed in western society.¹¹ Perhaps the apparent spiritual disorientation of industrial man is a reflection of the acoustic pollution industry has created. The strongest negative effects of industrial sound may even be inaudibly incurred –the mind automatically following external environmental influences that are not perceived in any conscious manner. Low frequencies of infrasound beating directly engender brainwave states.

Ronald DeStruelle, director of Holistic Programs, Inc., has developed *the tri-thalamic entrainment format* of 1.45 Hz.¹² Such deep delta heartbeats promote entrainment between the hypothalamus, pituitary and pineal centers of the brain. This format is reported to synchronize the functioning of the brain-stem areas also known as the extended reticular-thalamic activation system, implicated in a variety of functions associated with consciousness. The word reticular means ‘net-like’ and the neural reticular formation itself is a large, net-like diffuse area of the brainstem. The reticular system interprets and reacts to information from internal stimuli, emotion and beliefs as well as external sensory stimuli by regulating arousal states, focus, and the level of awareness – the fundamental elements of consciousness.¹³ Tri-thalamic entrainment provides significant orientation for individuals with Dyslexia and Alzheimer’s through coordinated brain function.¹⁴ The hypothalamus is involved in instinctive and emotional response, as in extreme reactions of rage or fear, states that can even be stimulated by particular low frequency sounds. The pineal gland is a tiny, light sensitive organ responsible for the production and regulation of melatonin, a hormone important in the coordination of sleeping and dream cycles, and has been shown to influence cellular longevity in the body. The pituitary gland regulates various hormone levels involved in growth, reproduction and various glandular functions including thyroid excretions.

The aligned beating of this three-part system has been observed to illicit a holistic set of changes in consciousness and alterations in the chemical balances in the entire body. Entrainment frequencies on the beta/alpha border have been shown to facilitate sensory integration,¹⁵ capable of leading human consciousness into a state of *synesthesia*, a complete integration of the senses. The synesthetic state is one of 'joined sensation', an involuntary experience of the co-mingling of images, sounds, smells, and tastes. A synesthete may describe music whose sounds look like shards of crystal, an eddy of multi-colored triangles flowing in the visual field,¹⁶ or seeing the color red accompanied by the scent of red. Synesthesia appears to be an inherited trait associated with the X chromosome, as the female to male ratio is 5:1 among synesthetes and tends to occur in families, sometimes skipping a generation.¹⁷ One of the predominant effects of this type of joined perception is extremely heightened acuity of memory, perhaps attributable to the vividness of the joined sensory experiences themselves.

This unified state of perception is perhaps the ultimate goal of the ancient psychoacoustic technologies, whose makers' very languages used images to express complete concepts linking sacred smells, sounds and colors. The holism of the synesthetic awareness was deeply expressed in the cosmivision of the Maya people of the Yucatan whose language includes the sounds of birds, and whose architecture functions as a solar calendar. The possibility of the ancient use of psychoacoustic entrainment as a developmental tool for infants to encourage synesthetic modes will be addressed by further investigation of the meaning underlying the symbolic images glaze-painted or engraved on the instruments. The oldest examples of psychoacoustic ceramic vessels in museum collections perhaps come from the Olmec, yet comprehensive frequency comparisons from this culture have not been made. The origins of this sophisticated technology predate the Olmec culture, yet are represented by few surviving entrainment instruments fashioned from stone. The symbolism crystallized in these rare instruments sheds light on the cosmivision behind their advanced holistic use in the development of consciousness throughout the lives of their users, starting from infancy and even employed during fetal gestation in the womb.



The vast numbers of psychoacoustic whistling vessels used by virtually all advanced cultures of the Andes for many thousands of years show an equally vast array of symbols that provide penetrating insight into their developmental purpose. The concept of flight and the use of flying animals in their symbolic forms and engravings refer to the lofty spiritual aspiration of the human soul, often linked to the image of the winged serpent and the hero twins – a direct reference to DNA, the seat of human consciousness found in our every cell. The flying creatures continually seen in these representational vessels are feathered birds often accompanied by waveforms that are traced through the air by their flapping wings. The form of a bat is also commonly used across Andean and Central American cultures to reference both the transcendent capacity for flight, employing echolocation as a metaphor for the penetrating sight of the 'third eye.' One red bat vessel even shows mirrored pyramids in the form of wings (2.6).

2.6. Whistling vessel in the form of a bat with octahedral-shaped wings

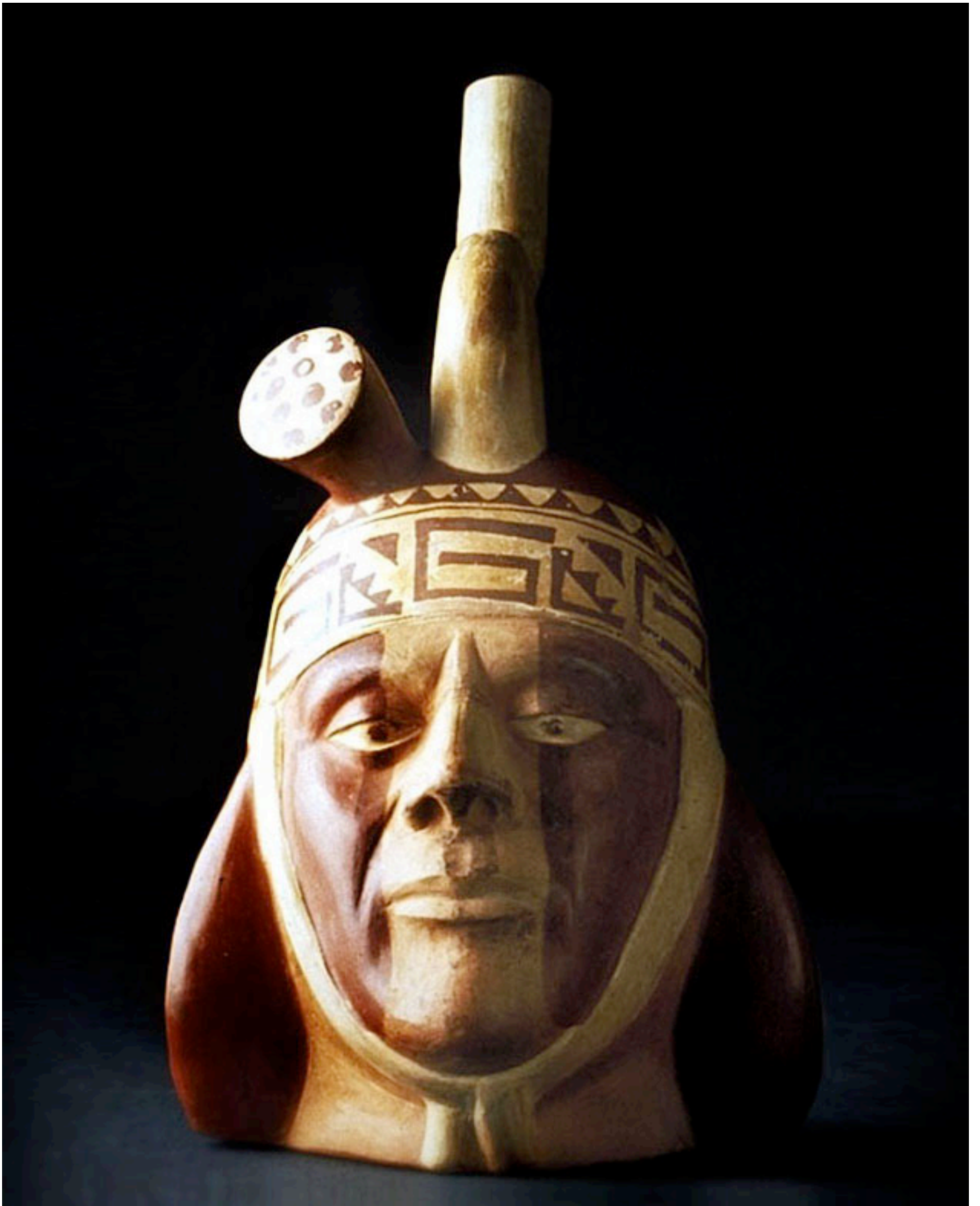

2.7. Moche portrait vessel glaze-painted with stepped zigzag waveforms and an octagonal array of circles in red
2.8. (Opposite) Moche vessel with cross-patterned discs on his headband, holding an octagonal patterned plate





2.9. Andean wave-patterned textile

What deeply penetrating knowledge of consciousness these Andean ancients possessed, and what simple techniques they used to such profound effect. The symbolic language that imbues the forms and surfaces of the psychoacoustic instruments are repeated across cultures in the Andes, and echoed around the globe in sacred patterning. The predominant psychoacoustic symbol found in rock art worldwide, on megalithic stonework and ceramics is the sine wave –the pattern by which sound propagates through air. A commonly seen acoustic design is the zigzag line, sometimes doubled, in nested rows, mirrored on itself or in concentric diamonds. The waveform has a multitude of variations including the square wave, interlocking S waves and curling wave crests. The hemispheric synchrony symbolism of interlocking S curves and swirls is presented in the complex banding of a woven Inca bag, with an interplay of positive/negative shapes in off-white and red (2.9). Note the offset sizes of the two largest interlocking S curves, the top S being smaller than the one below, a perfect visual description of the offset wavelengths of psychoacoustic whistles. The interlocking swirls can be seen in four sizes, displaying what modern science would define as self-similarity. The visual symbols that accompany sacred instruments profoundly exhibit the ancient knowledge of the phase structure of the wavelengths used to enhance human consciousness.

The sound of the hummingbird's wing beats serves cross-culturally as a sacred symbol for psychoacoustic beat frequencies. The wing beats of large species can be as low as 10 Hz while the most agile of hummingbirds can exceed 150 Hz. The hummingbird is represented consistently on the vessels themselves, in textiles and in the forms of gold earrings¹⁸ adorning the hearing system they entrain. Many types of birds and other sacred animals are also deeply associated with psychoacoustic beats. The flight of birds is associated with low frequency sound wave propagation by alluding to the sine-wave motion of beating wings. The sacred bat, dolphin and whale are often represented in respect for their advanced echolocation capabilities and frequency ranges. A species of thorny oyster, the *Spondylus*, is also deeply associated with sacred sounds, as are the snail-shell forms of Inca whistling vessels (2.5), both appreciated for their beautiful presentation of Fibonacci order, a topic discussed later in detail. The cat is a psychoacoustic symbol as its purring entrains brainwaves to enhance healing and concentration, ranging between 25-50 Hz.¹⁹ The powerful puma and jaguar were central symbols of the Olmec and Maya Mesoamerican cultures and the Andean Inca, whose capital Cuzco is constructed in the design of a puma and whose many temples resonated with the purring sound of their instruments. Whistling vessels are also often ornamented with the spiral, a hypnotic reference associated with rotation, gravity and inward reflecting consciousness. The spiral path was also well known by these ancient astronomers to be the form underlying our galaxy, whose sacred cosmic architecture could be accessed and understood through the entheogenic sounds of synchrony. Perhaps the most unsettling image common among ancient Andean textiles is a diminutive figure with trance inducing, almond-shaped eyes.



2.10. Chancay three-tone vessel formed as an oculate being with waveforms extending from the mouth to the ears resembles Dogu figurines from Japan (above, right) and plaster figures from Ain Ghazal, Jordan (below, right)

The oculate being is often associated with psychoacoustic imagery, usually presented with the twin serpent motif and whistling vessels, a supernatural being of dwarf-like stature. Oculate depictions are most recognizable by the triangularly shaped head, large mesmerizing eyes and miniscule ears –usually presented with its small mouth open producing sound. A psychoacoustic whistling vessel in the form of an oculate being from the Chancay culture (2.10) with raised open palms is glaze-painted with waveforms moving from its open mouth to its ears. While the infantile body is rendered naturally, the head is treated as a flattened, angular form framing a small face. The oculate vessel eerily depicts six fingers on each hand, further suggestion of the unearthly origin of the being. The triple whistle’s holes are located at the top of the head, and would have been ritually sounded from a seated position behind the diminutive figural vessel. The oculate being is depicted in like resemblance all over the world in ancient artwork, an enigmatic phenomenon with a deeply veiled presence in the human collective unconscious.



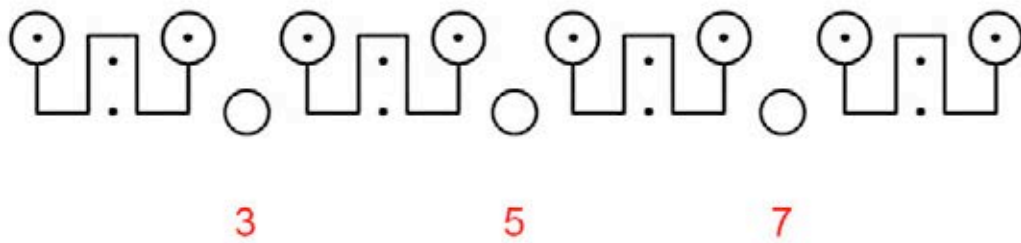
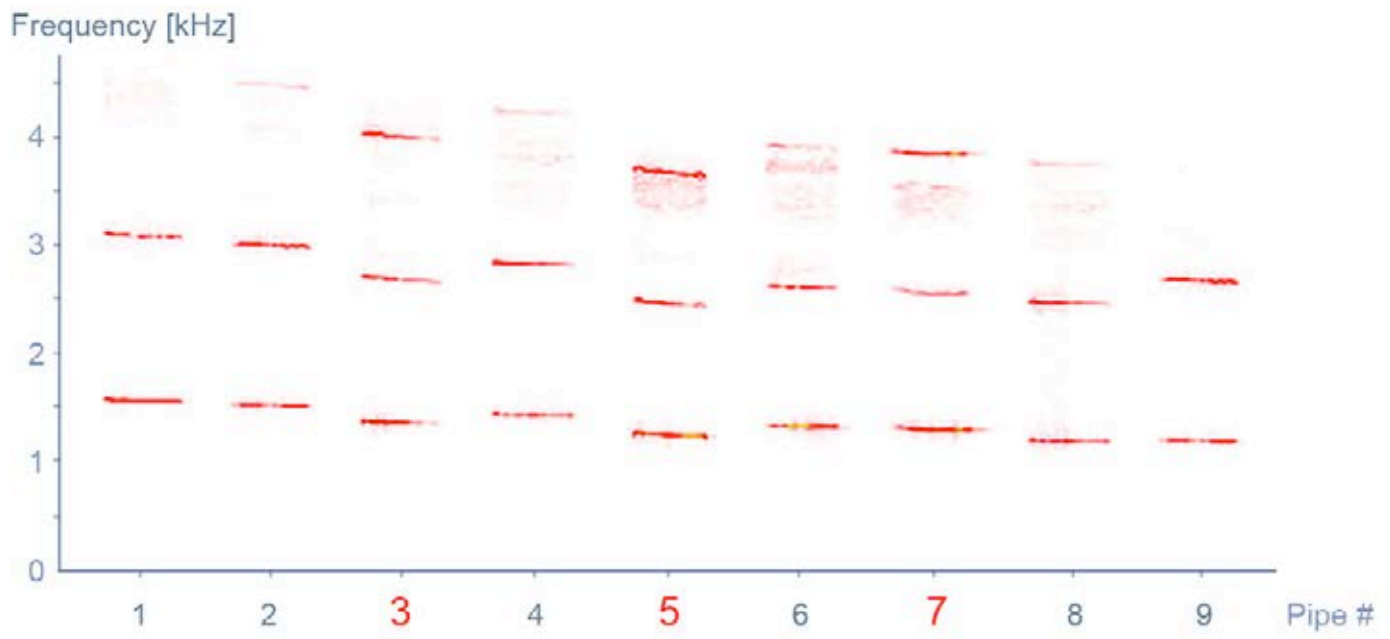

2.11. (Opposite) Stone masks with inlaid turquoise details and a ten-tone panpipe with hero twins and two pumas
 2.12. Sonogram of the 9-tone panpipe revealing the tri-frequency output of the prime 3rd, 5th and 7th pipes (above);
 9-tone panpipe with oculates, songbirds, square waveforms and engraved diagram of the prime pipes (below)

Recent findings on the Bolivian altiplano have included a more ancient form of psychoacoustic instrument, rendered in stone. A group of several intricately designed and engraved black stone relics was collected from an area of brushy highland, including a smoking pipe, two ceremonial cups, five psychoacoustic panpipes and five inlaid masks of which one is also a whistle. The set of unique artifacts appears to be carved from a finely grained type of black stone that eludes scientific identification. The stone masks are thin, yet still quite heavy, the eyes inlaid with turquoise irises. Elaborate psychoacoustic symbols lace the black stones' polished surfaces, including zigzag, diamond, and square waveforms. Two of the masks also have three dots of the same inlaid turquoise extending below each eye (2.11), perhaps symbolic of the penetrating gaze of a supernatural being, distinguishing them from the other masks of the group. This pair of masks seems to represent oculate and human beings in opposition to each other. One appears to be an oculate being with characteristic triangular head, bearing its teeth as snake-like patterns exude from its eyes. By sharp contrast, the other being appears very human-like with a long face and mouth open in chant, and a whistle at the crown. Symbolic psychoacoustic animals grace the whistling mask, including the hummingbird and the cat, as well as a pair of spirals engraved near the ears of the mask's wearer. The head of a llama forms a comfortable handle at the chin.

These five black stone panpipes are perhaps the most sophisticated psychoacoustic instruments yet discovered, and despite having sustained some minor damage they can still be played to profound effect. These strangely designed stone panpipes have resonators formed by interconnecting holes unlike the typical Andean open-ended panpipes used today. In fact, all five of these black stone panpipes have been fashioned with small holes connecting adjacent resonators at the bottom of their 2' drilled depth, allowing air blown into one pipe to exit through each of the two adjacent pipes. This curious feature requires very high air-pressure to produce a tone, perhaps more than double the amount required to play contemporary panpipes, as noted by an expert Bolivian panpipe player after much exertion. My own experience in playing the psychoacoustic stone whistles of the Chinchorro was adequate training to allow me to produce and record the tonal ranges of the Bolivian stone panpipes.

Interestingly, the panpipes' tonal progressions are not ascending but staggered such that each tone is adjacent to two higher tones or two lower tones that receive airflow from the central tone being played. The curious result of the tunings of the connected air passages is the simultaneous production of *three harmonic tones* that entrain consciousness. Sonograms of the stone panpipes reveal their complex frequency output, including which resonators can produce the special triple-tone. The tonal sequence of the 9-tone oculate panpipe (2.12) ranges between 1240–1500 Hz, presenting a structure that emphasizes prime numbers 3, 5 and 7 as resonant numbers, for only these three resonators can produce the high-frequency third harmonic. The row of geometric patterning just below the resonators visually describes their linked airflows, yet also emphasizes the special harmonic output of 3rd, 5th and 7th tones. The oculate panpipe is so named for its patterned depiction of the triangular-headed oculate being, above a row of square waveforms and another of songbirds. The set of three harmonics achieved by these unique panpipes informs the meaning of the pattern of three dots observed below the turquoise eyes of the supernatural masks, the subtle acoustic levels given symbolic form rising from the mouth to the enlightened eyes above. The symbolism and location of these finds suggest an association with the advanced megalithic ruins of Pumapunku and Tiwanaku.

The 10-tone hero twins panpipe (2.11, 2.14) presents an identical tonal range of 1240–1500 Hz, with harmonics above due to the linking of the airflows through adjacent pipes and a similar staggered tonal sequence, suggesting that it was likely tuned and used with the 9-tone oculate panpipe. The triple harmonic tone is also observed of the prime 3rd, 5th and 7th tones, marked on this instrument by the dotted circles at the heads of the hero twins. The 5th tone is emphasized by the figurative designs as it has no borderline (unlike the surrounding resonator pipes) and sits along the carved hero twins' axis of symmetry. The 10th tone is also left borderless, an additional resonator cavity perhaps added to provide an airflow exit for the 9th tone, achieving the critical highest harmonic like the 3rd, 5th and 7th of the set. While both the hero twins and oculate panpipes have two damaged resonators, the unplayable tones can easily be inferred from the mirrored symmetry of odd numbers centered on 5. The especially resonant prime tones are each adjacent to higher notes on either side, perhaps also contributing to their enhanced

harmonic output. The reverse side of the hero twins panpipe bears another unmistakable reference that underscores the deepest purpose behind the psychoacoustic technology: kundalini stimulation. This most complex panpipe depicts an infant whose spinal column is flanked by spiraling waveforms (2.14) that seem to move energy upward and out of the infant's outstretched arms. Kundalini is an ancient Sanskrit concept of an energy cord within the body that moves upward along the spinal column towards the top of the head, just as presented in the panpipe's engraving, part of a complex system of belief thought to have originated in sub-Himalayan Asia that seems quite out of place in the Andes. Extensive further evidence from the Andes exists to support the enigmatic presence of Sanskrit cultural ancestors in the distant antediluvian past, a context that illuminates the veiled origin of these psychoacoustic traditions. The tonal structures of these complex panpipes encode the mathematics of prime numbers that unfolds as a defining feature of an advanced culture made coherent through neural synchrony. The repeated use of dotted circles seen throughout this collection of Bolivian artifacts reference the resonant effect of these psychoacoustic instruments that unify the collective consciousness.

2.14. Stone smoking pipe with a handle formed as an infant holding a panpipe; a 5-tone panpipe engraved with 5 meditating figures; and an infant engraved on the reverse side of the 10-tone panpipe (front side seen in 2.11)



The 5-tone thought pattern panpipe is engraved with five figures in synchronized meditation (2.14, top right), with a frequency range of 1600–2000 Hz. The resonators atop the head of each engraved figure are designed with a different patterning in the brain region corresponding to the effect of each tone. The three central figures are presented with symmetrical or synchronized brain patterns, while the first and last figures show asymmetric brain patterns, again implying that the harmonics produced by the linking of three adjacent resonators is responsible for the integrated hemispheric brain function. The prime 3rd tone is centrally placed and also capable of producing the special triple-harmonic tone. The variety of hemispheric synchrony patterns provided is remarkably broad, presenting clear psychoacoustic symbols and direct visual descriptions that coherently convey the complex function of advanced cultural practices once used as a tool for developing the synesthetic capacity of human consciousness.

Two 3-tone panpipes complete the lithic ensemble, one of which is large enough to be held in two hands and played upright producing the lowest frequency of the group at 760 Hz (2.15). The smaller of the 3-tone panpipes has resonators carved as pumas with open mouths, and produces tones near 1300 Hz. The rest of the panpipe forms a boat-shaped palette with four legs that allow it to sit horizontally. The larger 3-tone panpipe shows a very complex design with groups of engraved figures, patterns and square spiral motifs. This stylistic complexity is equaled by the engineering of the airflow interconnections of the 3 pipes that require an enormous lung capacity to produce any sustained tone. The instrument appears to have been designed with 3 holes that can be covered by the fingers to modulate or alter the airflow through the resonators, yet without rediscovering the hand position or playing technique the tonal potential of this instrument is not yet fully known.

The tri-frequency tone produced by the linking of adjacent resonators in these remarkable Bolivian panpipes was likely achieved in lower frequency ranges using this large oblong 3-tone panpipe, although it has not been successfully played. The potent effects of these sophisticated black stone panpipes were deeply felt during my experimentation and recording sessions. The very high air-pressure required to sound the panpipes' linked resonators becomes a significant factor in their function, quickly increasing the amount of oxygen to the brain during continual intonation. After only minutes of use the instruments begin to produce a noticeable sensation in the body that I will try to describe from my own personal experience. The internal sensation of one's own biorhythms becomes quite powerful, a throbbing followed by minute muscular spasms beginning around the mouth and extending to the abdomen. The rhythmic spasms seemed to be concentrating along my body's central line of symmetry, giving the feeling of an alignment of an energetic axis that lasted for over twenty minutes after the cessation of the sounding. This heightened state of biorhythmic awareness appears to be induced by the tri-harmonic tones, quite beyond the experiences produced using simpler bi-frequency psychoacoustic whistles.

The wide-eyed infant symbol is found on many of the stone objects, most notably seen in the 10-tone panpipe as kundalini imagery. The infant's exposure to the harmonic frequency output of the psychoacoustic panpipes is emphasized by the well defined ears of the baby who holds the stone panpipe, also shown in the forms of a smoking pipe with a figural handle (2.14). The high air-pressure required to sound the panpipes precludes the possibility of the infant actually playing the panpipes, suggesting the association between the two is likely based on the entrainment effect of the tones on the developing newborn's mind. The apparent focus of the psychoacoustic tradition upon infant neural development is an inherently maternal expression. The possible inference of a matriarchal cultural context for these artifacts is further explored in following chapters, as the referencing of acoustic fetal development is seen in other ancient stone artifacts from the Andean region. The kundalini energetic teachings of the ancient Sanskrit culture will be further discussed in later chapters as being the original source of psychoacoustic traditions in the Andes and indeed the whole world.

The clear developmental role of the stonework occurs on many levels in hemispheric synchronization within the individual and group, entraining unity. The potent tones produce meditative states that immediately regulate biorhythms down to the cellular level, each and every strand of DNA becoming 'denatured' or completely unwound.²⁰ Binaurally induced meditative states appear to actually allow a heightened function of DNA replication, repair and transcription that regulates proteins and enzymes



2.15. Stone panpipe with waveforms and three chanting figures; and another similar 3-tone panpipe with a boat-shaped palette and three pumas



2.16. Two stone cups, one showing an oculate being and the other with a handle carved as a face in deep meditation

vital to cellular physiology. Apparently latent functions of DNA become activated by pulsed sound, leading to a new understanding of the molecule of life being quasicrystalline, a non-periodic lattice²¹ capable of quantum function as observed in cases of synesthesia. This paradigm shift in our understanding comprises a new key to unlock the secrets of ancient advanced human technology once used to unify collective consciousness by synchronization.

Among the stone artifacts from the Bolivian altiplano were discovered two stone drinking vessels covered with geometric engravings, both showing similar short-handled designs (2.16). One cup engraved with an oculate face has a handle shaped as a feline head, and the other cup's handle shows a meditating man. The resonant crystalline stones from which these masterworks were made are of the same types used in resonant architecture around the world. Natural resonant environments have been sought out and used to induce altered states of consciousness by indigenous cultures the world over in canyons, cliffs and rock shelters. Ochre painted and engraved rock art throughout the world has been clearly identified as indicators of sacred locations with resonant geometric features that generate echoes that amplify the psychoacoustic effects of trance drumming and chanting.²² Indeed, the most profound psychoacoustic effects are generated in the acoustic galleries of subterranean cave systems.

The Andean tonal instruments were employed at megalithic sites constructed with massive stones as acoustic transducers. Enigmatic constructions from around the world must be reinterpreted as psychoacoustic architecture –a monumental extension of the musical instruments and human voices that resonate within the chambers. While psychoacoustic instruments synchronize the practitioners, the buildings themselves may also have resonated in synchrony with each other in a global acoustic resonance network. Megalithic structures cross the globe pose deeper questions about the psychoacoustic applications of the deep past.

References

- ¹ Oster G (1973) 'Auditory Beats in the Brain' *Scientific American* 229, pp. 94-102
- ² Ibid, p. 96
- ³ Morris SE (1990) 'Hemi-Sync and the Facilitation of Sensory Integration' *Hemi-Sync Journal* 3, pp. 5-6
- ⁴ Newman J (1997) 'Putting the Puzzle Together, Part I: Toward a General Theory of the Neural Correlates of Consciousness' *Journal of Consciousness Studies* 4, pp. 47-66
- ⁵ Kennerly RC (1994) 'An Empirical Investigation into the Effect of Beta Frequency Binaural Beat Audio Signals on Four Measures of Human Memory' Department of Psychology, West Georgia College
- ⁶ Garret S, Statnekov DK (1977) 'Peruvian Whistling Bottles' *The Journal of Acoustical Society of America* 62, pp. 449-455
- ⁷ McMoneagle J (1993) 'Mind Trek' Hampton Roads Publishing Company
- ⁸ Hiew C (1995) 'Hemi-Sync into creativity' *Hemi-Sync Journal* 13, pp. 3-5
- ⁹ Monroe R (1985) 'Far Journeys' Doubleday
- ¹⁰ McAuliffe K (1983) 'Brain Tuner' *Omni* 5, January
- ¹¹ Worthington A (2007) 'The Radiation Poisoning of America' online
· <http://www.worldhealth.net/p/the-radiation-poisoning-of-america.html>
- ¹² DeStruelle R (1989) 'Letters to Jonathan Goldman' October 10, November 12
- ¹³ Empson J (1986) 'Human Brainwaves: The Psychological Significance of the Electroencephalogram' Macmillan Press Ltd
- ¹⁴ Goldman J (1992) 'Sonic Entrainment' online
· <http://www.healingsounds.com/articles/sonic-entrainment.asp>
- ¹⁵ Morris, op cit
- ¹⁶ Cytowic R (1995) 'Synesthesia: Phenomenology and Neuropsychology, A Review of Current Knowledge' p. 1, online · <http://psyche.csse.monash.edu.au/v2/psyche-2-10-cytowic.html>
- ¹⁷ Van Leeuwen T (2004) 'The Neural Basis for Synesthesia' p. 6, online
· http://bar.psych.ubc.ca/PDF/VanLeeuwen04_synpaper.pdf
- ¹⁸ Statnekov DK (2000) 'The Hummingbird Clue' online · <http://www.peruvianwhistles.com/hummingbird-clue.html>
- ¹⁹ Chen LP, Han ZB, Yang XZ (1994) 'The Effects of Frequency of Mechanical Vibration on Experimental Fracture Healing' *Zhonghua Wai Ke Za Zhi (Chinese Journal of Surgery)* 32, pp. 217-219
- ²⁰ McCraty R, Atkinson M, and Tomasino D, op cit
- ²¹ Selvam AM (2004) 'Quantumlike Chaos in the Frequency Distributions of Bases A, C, G, T in Human Chromosome1 DNA' *Apeiron* 11, pp. 134-144
- ²² Waller S (2002) 'Psychoacoustic Influences of the Echoing Environments of Prehistoric Art' *The Journal of the Acoustical Society of America* 112, p. 2284

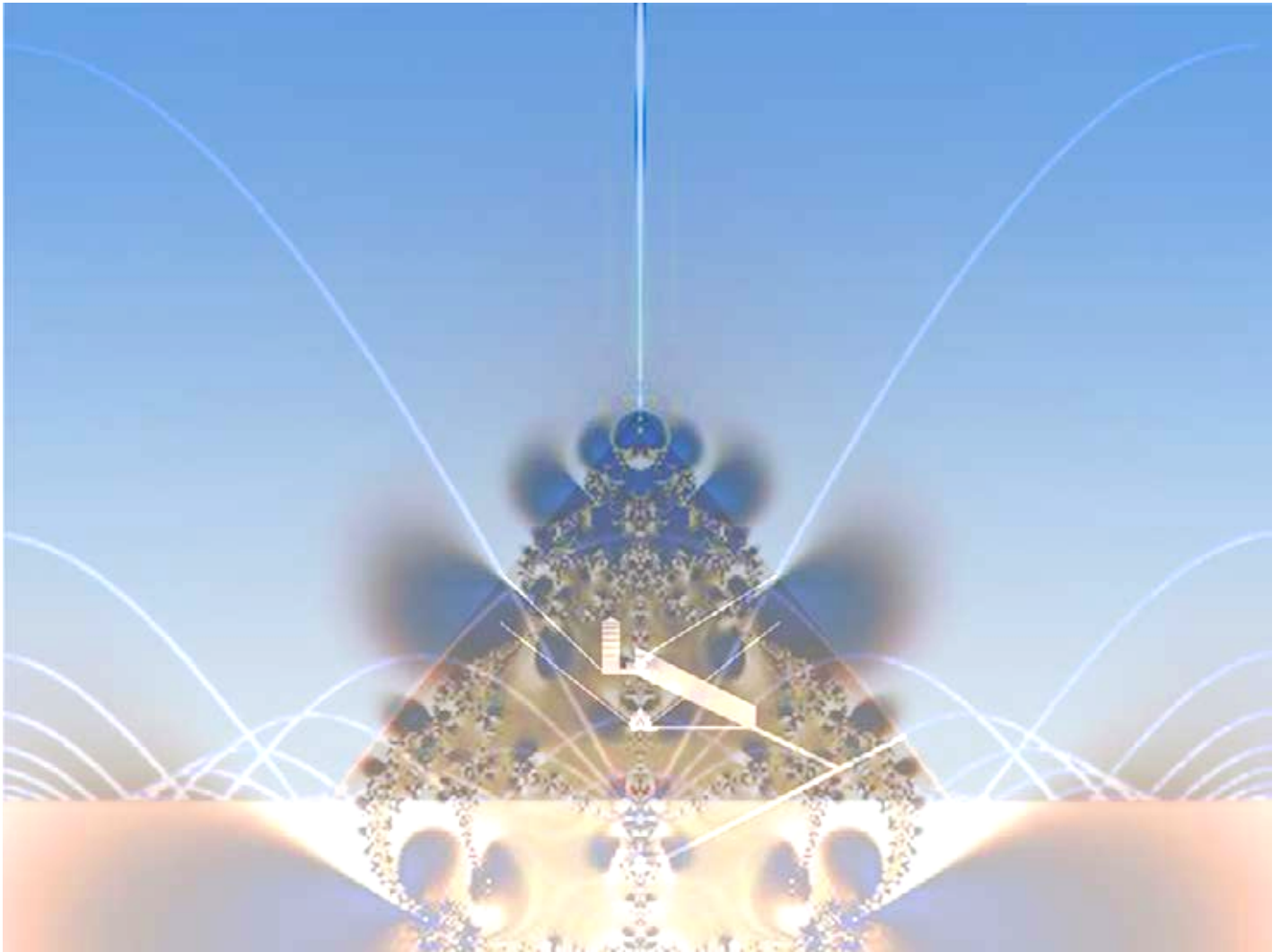

3
Biorhythmic Pyramids

Biorhythmic Pyramids



3.1. Aerial view of the ancient Sanskrit pyramids of Giza, Egypt positioned along the sacred Nile River Valley

A defining aspect of ancient advanced human civilization is evident on every inhabited continent of the planet: massive piles of crystalline stone. This enigmatic tradition can now be understood for its most deeply penetrating purpose that has evaded modern comprehension. This monumental consciousness entrainment technology reaches its pinnacle in the megalithic psychoacoustic architecture of the pyramids of Giza, Egypt (3.1). The plateau and monument was referred to in antiquity by the ancient Coptic name *Ros-Tau* or 'Rose-Cross', the meaning of which becomes apparent in the mapping of cymatic patterns formed of infrasound standing waves transduced by the limestone and quartz crystalline structures. The Giza pyramid complex is an ancient solid-state psychoacoustical technology piezoelectrically transducing Schumann Resonance, ultra low frequency (ULF) waves from 20 Hz to 0.5 Hz that emanate from the magnetic North pole. These frequencies correspond to the alpha, theta and delta brainwaves, entraining human consciousness into meditative states and oneness with the Earth.

The Giza pyramid complex has lasted for millennia as the most enigmatic monument of humanity, three man-made mountains of stone. An understanding of the construction methods of the pyramid builders has eluded modern research, and the full purpose for the mathematical precision of the architecture has remained a deep mystery. Egyptologists have proposed that the pyramids were constructed as tombs for Pharaohs, the burial riches and artifacts having been looted long ago. While the Egyptian afterlife beliefs are well documented, the pyramids lack all of the characteristic tomb features found in confirmed

Pharaonic burials, including the lethal paints mixed with poisonous fungi used in the sealed tombs¹ that gave rise to speculation about the mummy's curse after the death of several inquisitors. The acoustic effects experienced by the living human body in the Great Pyramid's chambers are so powerful that it is unlikely to have been used as a tomb for the dead. The upper chamber's granite box is an astounding resonator designed for biorhythmic entrainment of the human mind and body. These and many other aspects of the Giza enigma suggest that the Orion pyramids predate Egyptian culture. If not the Egyptians, what unknown ancient culture is responsible for the construction of those pyramids?

The only key to deciphering this mystery is mathematics, and the equations have all been left to humanity in the limestone and granite blocks of the monuments themselves, inviting us to solve the four-dimensional puzzle of the pyramids. Twenty-first century physics has made paradigm-shifting breakthroughs in the fields of quantum biology and nonlinear acoustics to inform a new understanding of the design function, nonlinear mathematical symbolism and harmonic tradition left to humanity in monumental stone. The hypothesis given herein provides a complex quantitative model of the global pattern of Magnetic Resonance transduced by the Giza pyramid complex from the natural planetary field of ultra low frequency resonance. Based upon the Golden Section or *phi* geometry evident in the pyramidal design and the global positions of megalithic constructions, it is the conclusion of this author that the Giza pyramids are the driving force behind a global harmonic oscillator: the ancient ayurvedic architectural science of synchronized consciousness.

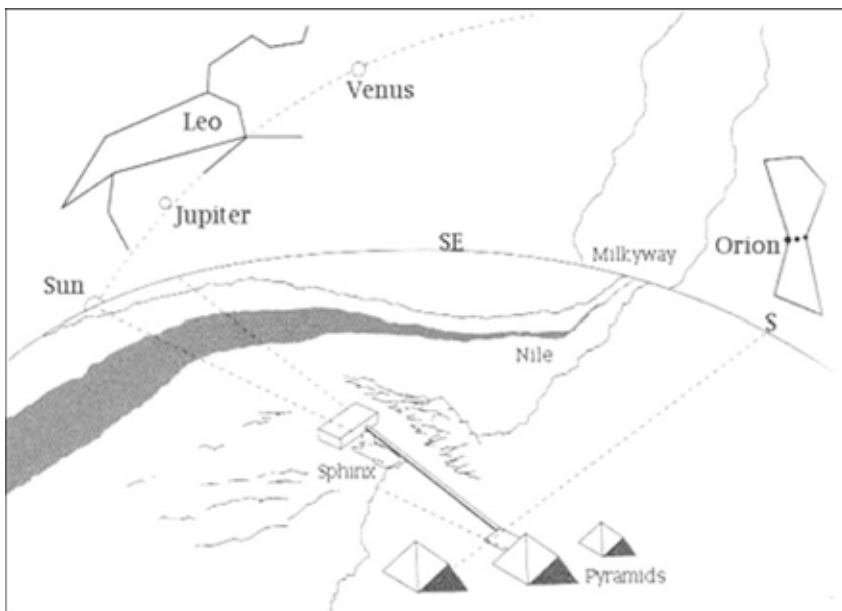

Archaeologists have studied the pyramids for over a century looking for the fabled Hall of Records, hoping to find a massive library of sacred texts. This research into the nonlinear psychoacoustics of the Giza Orion complex has revealed that the language of its builders is purely mathematical, that their mathematical records have been left all over the globe in monumental stone. Through fractal geometry the Hall of Records is now being opened, and in it is revealed a global mathematical model of consciousness leading the way to a new understanding of the harmony of an advanced global Sanskrit mother-culture that has become long since lost to 'the terror of history'.

3.2. Giza pyramid alignment to the belt stars of the Orion constellation

The origin of the pyramid complex at Giza is the topic of much recent debate, yet the design mathematics and cultural symbolism used by the architects themselves must be taken as the final word. R. Bauval and A. Gilbert first described the pyramids' design as having been constructed in the triad star pattern of Orion's Belt, composed of Alnitak, Anilam and Mintaka,² and will be referred to as the *Orion pyramids*. This specific constellation symbolism has subsequently been identified in several other pyramid complexes in various continents of the world, confirming that the advanced monument-building culture was a global one that preceded Dynastic Egypt by millennia. The orientation of the Orion's Belt stars with the Milky Way has been represented on the Giza plateau in the relationship of the triad of pyramids to the Nile River, to the east (3.2). The Sphinx sits observing across the river the sunrise in the east, after a night watch of the ecliptic plane. The iconography of the Sphinx is calendar-related, as the human-feline symbolism signifies the constellation and Precessional Age of Leo, which last rose on the ecliptic horizon circa 12,500 bp.³ The combined stellar markers encoded in the layout of the Giza complex, supported by stone weathering pattern data, unmistakably demonstrates an astoundingly early



3.3. Giza, Egypt's Sphinx monument shows Sanskrit origins, with a headdress designed with the kundalini cobra hood

construction date, more than doubling earlier estimates erroneously based on Dynastic Egypt as the culture of origin. The work of R. Schoch,⁴ R. Bauval and G. Hancock⁵ have provided further support for the redating of the Sphinx by thoroughly documenting the weathering patterns apparent on its limestone surfaces. While flooding has produced horizontal water-wear along the lower neck and body, vertical water-wear striping is still preserved on the head and upper portions of the Sphinx. This vertical weathering is the result of consistent long-term rainfall, which last fell regularly in the Age of Leo before the Sahara desert was even formed. This striking conclusion forces a dramatic reevaluation of the cultural origins of the pyramids, informed by a renewed awareness of the biorhythmic effects of resonant stone chambers and the underlying relationships between the giant dimensions of the buildings and the long wavelengths of infrasound comprising the Earth's resonant frequencies.

The drastic climate change that occurred during the end of the Precessional Age of Leo was likely brought about by a catastrophic event that ended the ice age, causing global temperature and sea level rise, turning the fertile Pleistocene North African grasslands into the arid Sahara of the Holocene. The Nile's course also reflected this change, shifting its main tributary to its present north-south course, which was a lesser tributary during the early Holocene. The ancient location of the Nile watercourse extended approximately 50 miles to the west, the remnants of which exist as a series of oases extending roughly from northwest to southeast. Ancient megalithic stone buildings have been discovered near the ancient course of the Nile, clearly drawing water through stone aqueduct systems from the vanished westerly source, in the opposite direction from the present course of the Nile. The style of stonework of these ancient building complexes, as well as the Giza plateau's Wall of the Crow, is very reminiscent of the stonework of Machu Picchu and Saqsaywaman in Peru with colossal stonework including both complex polygonal and perfectly planed rectangular blocks. In addition, the Pleistocene sites along the previous course of the Nile lack the presence of hieroglyphic inscriptions typical of later Egyptian sites.

The use of water as metaphor for the reflective quality of the universe is also a hallmark of ancient Andean belief, a reference to self-similarity. The work of C. Dunn⁶ and S. Mehler⁷ in consulting the indigenous wisdom in the Giza area has revealed knowledge of the existence of an ancient lake surrounding the Sphinx and pyramids, dug out from the same massive limestone bedrock. Lake Hathor, as it is known, was filled by the very rains that wore the Sphinx's feline features. The symbolism of the lake water's reflection of the cosmos reinforces the monument's design layout in mirroring the three stars of Orion's belt. A former marine engineer J. Cadman has hypothesized that the unfinished but well-worn stonework of the Great Pyramid's subterranean chamber was the result of functioning as a sophisticated cavitating water pump system.⁸ Cadman has designed and built a functioning pump based on the geometry of the subterranean chamber, with its pit and channels that lead to an intake in the original lakebed. The hydraulic pump sent the force of tons of water into the confined space leaving the rough-hewn surfaces oddly smooth and worn including the uneven ceiling. Cadman's conclusion is that the subterranean chamber was designed as a periodic pulse generator that once echoed deep in the bedrock, the long duration of its functioning attested by water-wear. The uneven dimensions of this lowest chamber create a range of frequencies when stimulated by the periodic cavitation, with subharmonics likely falling into the range of inaudible infrasound measured as Schumann Resonance.

The electro-acoustic theory of planetary resonance was developed by Serbian American Nikola Tesla and identified by German physicist W. Schumann in 1952. Referred to as Schumann Resonance, the Earth emanates a set of fluctuating ultra low frequency standing waves that can be measured at varying levels around the world. The physical structure of the standing wave resonances has not been previously detailed, a process made difficult by their constant fluctuation. Earth's planetary resonance is generally thought to find its origin in the electromagnetic pulses produced by lightning resonating in the atmosphere. The hypothesis underlying the structural theory of Magnetic Resonance given herein is that the Earth is resonating in sympathy with the sun –the planet's piezoelectric stone, magma and core transducing the solar electron storms into a deep hum. Schumann Resonance is generally inaudible to humans, being comprised of a fluctuating set of infrasound wavelengths between 0 to 50 Hz. Earth's current base frequency fluctuates near 7.8 Hz and progress in frequency steps of approximately 5.9 Hz, extending to 50 Hz.⁹ The base resonance fluctuates irregularly between 7 and 8.5 Hz. To calculate the shifting set of resonances using the base frequency of 7.30 Hz, the 5.9 Hz progression of resonances follows: 1.4, 7.3, 11.8, 19.1, 25, 30.9, 36.8, 42.7 and 48.6. The inversion of this linear number series shows a reflective quality shared by another intriguing number series explored by Leonardo Fibonacci.

While Earth's resonance is expressed in a linear progression of frequencies, the acoustic wave structures of planetary resonance are described by the *nonlinear* progression reflecting the *golden ratio*. The golden ratio is based on the transcendental number *phi*, or Φ , a universal constant approximated by 1.6180339887498... Phi can also be defined by the equations $[\phi + 1 = \phi^2]$ and $[1 + 1/\phi = \phi]$. The golden ratio is 1 : 1.618. Also known as the Fibonacci ratio, this 'divine proportion' is expressed in the Fibonacci sequence –a series of whole integers beginning with 1 and increasing by the order of phi:

Fibonacci Sequence – 1, 1, 2, 3, 5, 8, 13, 21, 34, 55, 89, 144, 233, 377, 610, 987, 1597, 2584, 4181...



The relative lengths of a line segment divided using the Fibonacci proportion (above) can be accurately described by any set of consecutive Fibonacci numbers. This unique feature of the Fibonacci sequence is observed throughout the universe in a vast multitude of biological and astrological structures. Fibonacci order governs countless aspects of natural growth processes; the proportions of anatomical features in the bodies of animals, insects, the branching of plant segments and the symmetries of flower petals. Application of the Fibonacci proportion to the study of acoustic resonance and the relative distances between the ancient pyramid sites will be extensively discussed as the key to *sacred geometry*.

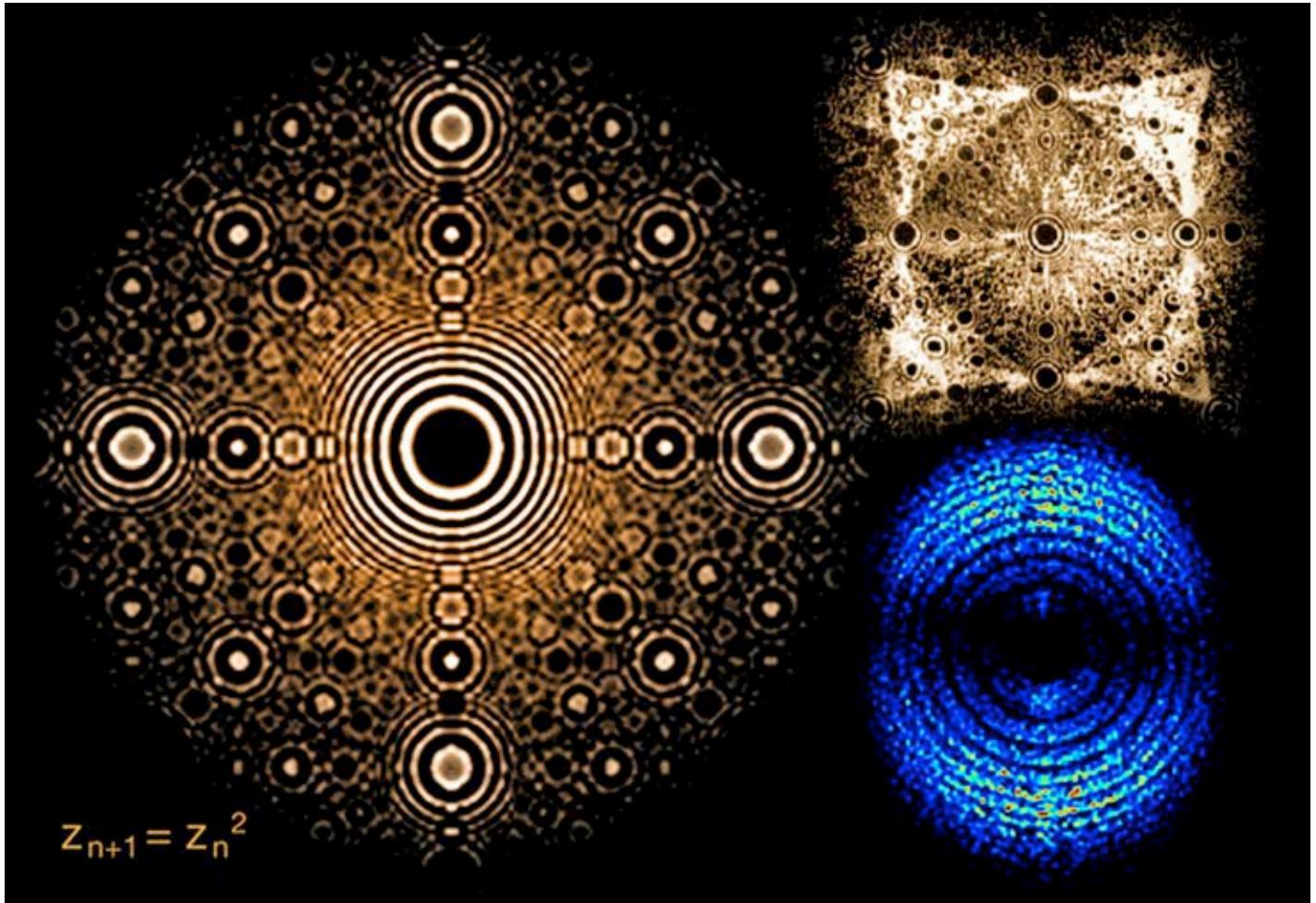

3.4. Quantum fractal (left) describes calcite refraction (top right) and the structure of the electron (bottom right)

Fibonacci order is displayed by quadratic equations that precisely reflect quantum structures observed throughout the fabric of the cosmos. The quadratic function $[z_{n+1} = z_n^2 \text{ modulo } n]$ is a seed formula from which is rendered a complex fractal map identical to the crystallography of calcite mineral (3.4). The phi-proportioned sizes and distribution of concentric circles along the octagonal axis is identified as the Square Fibonacci Tiling, defined in the equations of Lipshitz.¹⁰ This mesmerizing nonlinear octagonal tiling is observed not only in the refraction pattern of calcite, but is also reflected in the array of giant storm vortices turning the atmosphere of Jupiter and even in the composition of atoms themselves.

This fascinating quadratic quantum map also defines the structure of *the electron* recorded for the first time in 2008 (3.4). Researchers in Sweden have demonstrated an attosecond quantum stroboscope that releases individual electrons into the field of an infrared laser at exactly one electron per laser cycle:

The resulting electron momentum distributions are recorded as a function of time delay between the IR laser and the attosecond pulse train using a velocity map imaging spectrometer... This technique has enabled us to image the coherent electron scattering that takes place...¹¹

The newly developed stroboscope enabled the team to capture scattering images that form an oscillating animation of the electron. This detailed mapping of the electron's structure is precisely encoded by the seed formula $[z_{n+1} = z_n^2]$ — *a fact that has not been recognized until this writing*. Further applications of the quantum stroboscope promise to reveal more of the subatomic structural framework generally thought to be composed of standing waves and now seen for the first time in single electron scattering as Fibonacci-proportioned concentric circles. This remarkable quantum map embodies the unit of electric charge, the crystallography of calcite and the atmospheric resonance patterns seen on Jupiter.

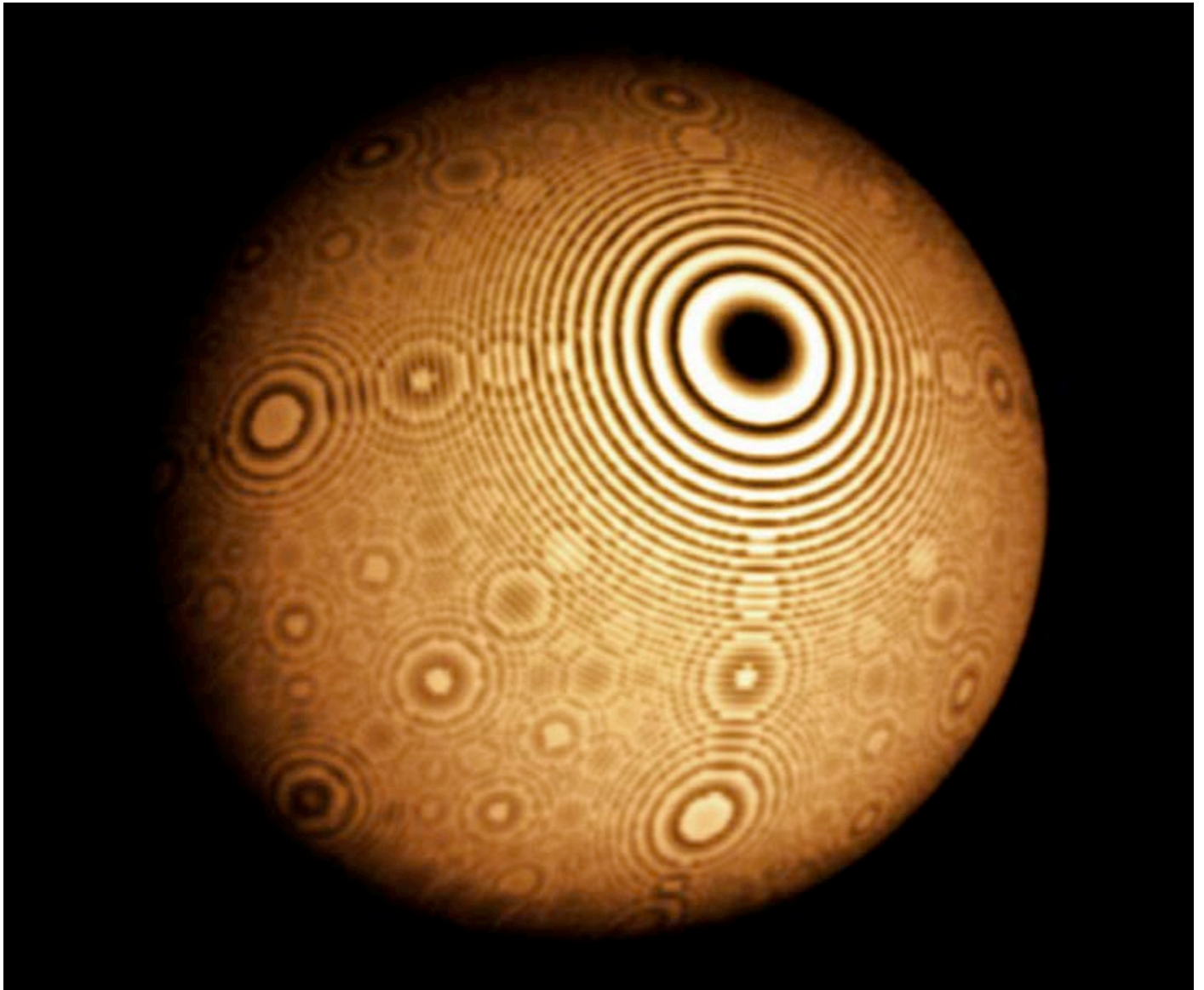

3.5. Spherical projection of the iterated function $[z_{n+1} = z_n^2]$ defines the nonlinear structure of Magnetic Resonance
 3.6. Hubble telescope images from May of 2008 reveal nonlinear vortical alignments in the atmosphere of Jupiter

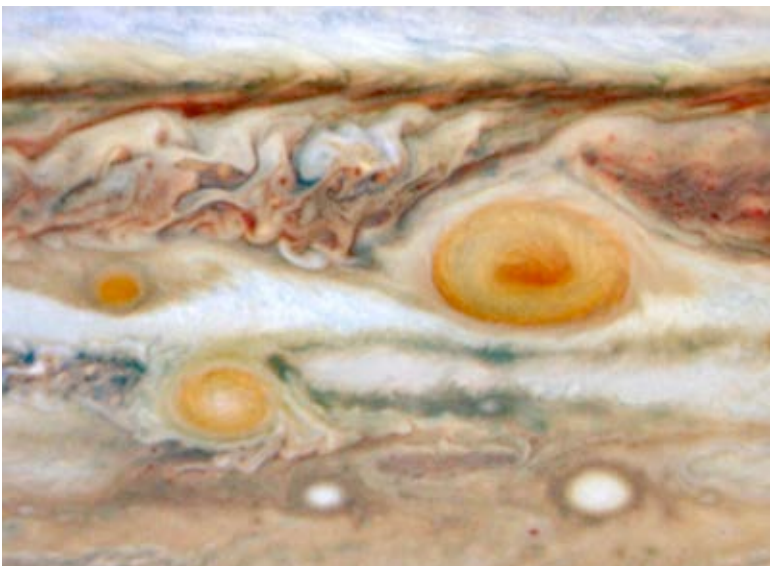

A spherical rendering of the quantum map has been generated to investigate the distribution pattern of the world's pyramids (3.5). This spherical model will be applied to Earth's geography to reveal the complex Fibonacci alignments of the world's network of pyramids—a theory of planetary infrasound that will be defined here as *Magnetic Resonance*. The inspiration to apply this quadratic formula on the planetary sphere originates with the identification of Fibonacci order underpinning Jupiter's array of swirling vortices that have become more dramatic in recent years (3.6). The size and distribution of standing storms reflects an identical nonlinear octagonal structure.

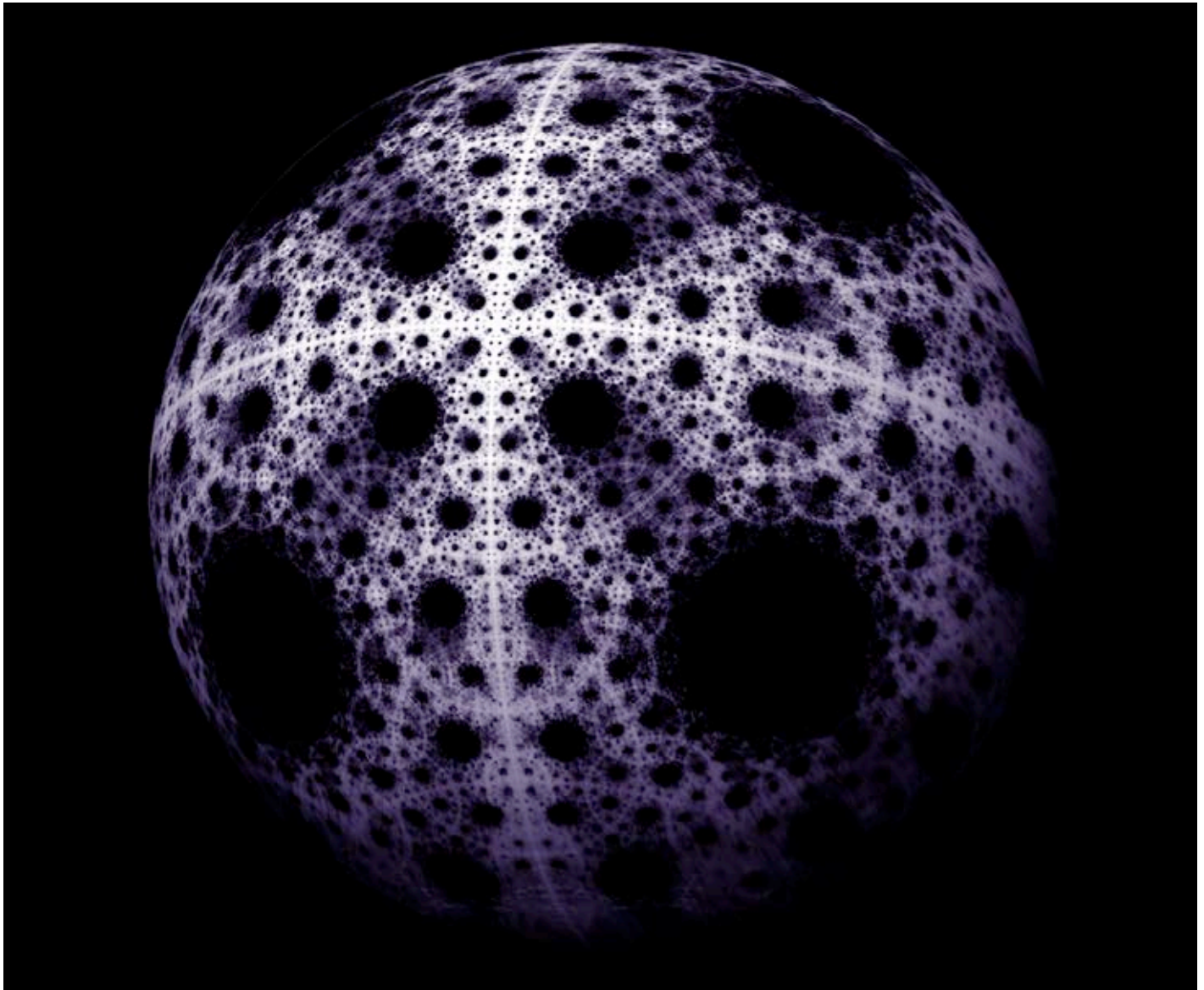

3.7. Composite spherical projection rendered from Jadczyk's Octagonal Quantum Iterated Function System

Any two consecutive numbers in the Fibonacci series can be added to produce the next consecutive number. It is like a numerical hall of mirrors in which one direction reflects the infinitely small and the other reflects the infinitely large. This series can be very useful as the ratios of consecutive values are identical, and can be manipulated to reveal Fibonacci proportions for any unit of measurement. Because the ratios between consecutive numbers in the sequence are identical, any set of consecutive numbers proportionately reflects the values of any other consecutive set (of the same length) from the series. The utility of this aspect of the Fibonacci series will be discussed in detail in the following chapter, as it allows the easy calculation of phi distances using any Fibonacci number set to define the unit used.

The spherical structure of Magnetic Resonance is rendered by iteration of the quadratic function $[Z_{n+1} = Z_n^2]$ that is a four-dimensional equation closely related to the Mandelbrot Set, $[Z_{n+1} = Z_n^2 + c]$, perhaps the most famous Fibonacci-ordered fractal (thoroughly discussed in the following chapter). Another corresponding octagonal Fibonacci tiling of the surface of a sphere has been derived through the algorithms of Jadczyk's Octagonal Quantum Iterated Function System¹² (QIFS) (3.7). The QIFS are generated by the framework of Event Enhanced Quantum Theory,¹³ developed by Jadczyk and Blanchard to address how quantum events come into being to produce the complex branching involved in the Many Worlds Interpretation of the universe:

The main thrust of quantum measurement theory is to explain the mechanism by which potential properties of quantum systems become actual. At the present time, this is no longer an abstract or philosophical problem since it is now possible to carry out prolonged observations of individual quantum systems. These experiments provide us with time series data, and a complete theory must be able to explain the mechanism by which these time series are being generated; moreover it must be in position to “simulate” the process of events generation.¹⁴

Jadczyk’s nonlinear Octagonal QIFS generates a quantum scattering pattern that is reflected throughout the complex systems of our universe. The QIFS describe the energetic structures of subatomic, molecular, planetary, solar and galactic formations as quantum systems in resonant operation. On the planetary scale this resonance pattern is observed in the atmospheric gyres of all the gas giants of our solar system, and on Earth defines the prime location and structure of the Great Pyramid of Giza and the distribution pattern alignment of all the ancient sacred sites of all kinds –worldwide. This complex hypothesis will be borne out by an analysis of the geositions of a great number of sacred sites relative to Giza that conform to the Octagonal QIFS. The octahedral symmetry of the crystalline calcite mineral that comprises the bulk of the Giza pyramids’ mass is precisely copied by the architects’ design as a truncated octahedron. Stimulation of the infrasound standing wave resonance is achieved by the cavitation pumping of the base chamber of the Great Pyramid at 1.45 Hz, corresponding to the monument’s base wavelength of 756’ that defines the structure’s resonant frequency.

The angular lattice of calcite is known for *piezoelectric* properties allowing its function as a transducer. The piezoelectric effect involves the conversion of mechanical (vibratory) energy to an electrical field in various materials including ceramics, limestone, granite, sandstone and even plastics. For a piezoelectric crystal, if mechanical stresses are applied on two opposite faces, electrical charges appear on some other pair of faces. The vibration of acoustic waves is transduced by piezoelectric crystals into an electrical field created by the unified vibration of the whole piezoelectric mass. Mechanical force applied to a piezoelectric material causes a molecular structural deformation resulting in a rapid continual reversal of electrical polarity, a quality referred to as *dielectric*. Water, a major constituent of the human body and the Earth’s oceans, is also a dielectric substance. Indeed, ocean processes produce the carbonates of limestone that are the most resonant and abundant of minerals of the planet’s lithosphere, revealing the entangled nature of Earth resonance, water and consciousness.

The abundant limestone formations and ocean water covering the surface of the planet act as natural transducers of Schumann Resonance, while the artificial geometries of the Giza pyramids have been specifically designed to focus the predominant north-south reverberation of planetary infrasound into the octopolar configuration defined here as Magnetic Resonance. While the geositions of a multitude of other man-made limestone structures will be used to verify the hypothesis, the phi design and internal chambers of Giza’s Orion pyramids will first be described geometrically and shown to conform to the standing wave resonance structure. Gugg et al. provide a basic mathematical model of spherical standing wave patterns showing Fibonacci ordered concentric rings of focused acoustic energy.¹⁵

This author’s theory of Magnetic Resonance is a four-dimensional model of standing waves derived by spherical projection of the quadratic function [$z_{n+1} = z_n^2$] and applied geographically as an ultra low frequency acoustic pressure distribution map. The congruence of Magnetic Resonance with the Octagonal QIFS, the crystallography of calcite and electron scattering reveals the fundamental *unified field* invisibly binding together all scales of the cosmos. This geometric extrapolation of a spherical \emptyset resonance structure will not only be supported by the aligned locations of ancient sacred sites but also by the serial repetition of the octagonal symmetry among the cultural traditions maintained at those same sacred sites. Sacred symbolism is found throughout the world in endless geometric variation, expressed in ancient cultural traditions of body painting, tattoos, jewelry, rock paintings, textiles, ceramics, stoneworks, megaliths, pyramids and geoglyphs. The cultural threads that bind together the tapestry of human knowledge find their unified origin in the most advanced technology of psychoacoustic consciousness that awaits renewed use by contemporary society. Despite being unused, the ancient global wireless infrasound network displays its profound purpose through simple geometric perfection.

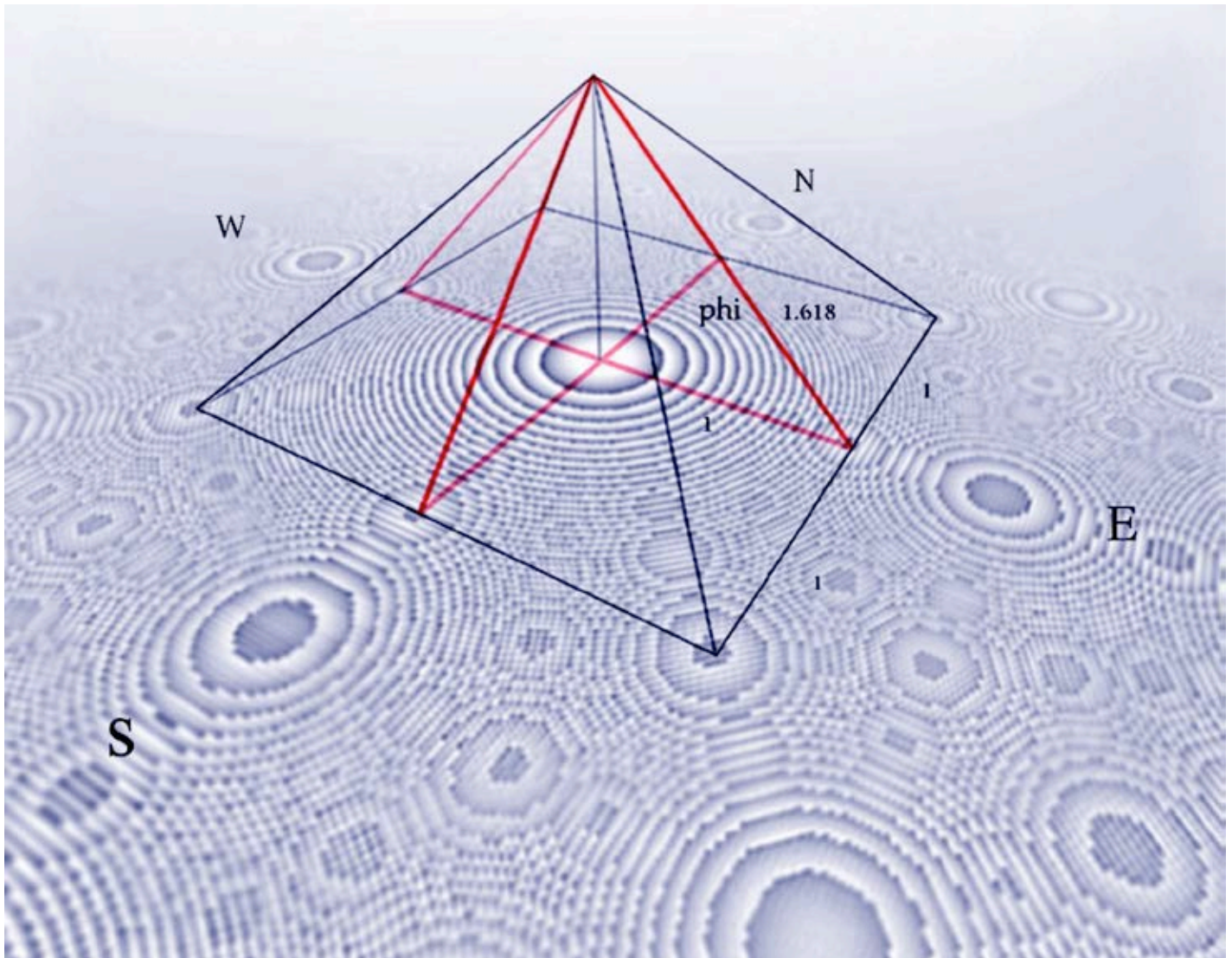

3.8. Giza Orion pyramids' quadrupolar phi angle (red) and acoustic pressure distribution of infrasound standing waves

The phi ratio defines the angles of the world's largest pyramid complex. From the central vertical axis of each of the Giza Orion pyramids the phi ratio is expressed in the four cardinal directions: north, south, east and west. The ratio of the apothem, or face slant height, to half a base side = phi. The angles of the phi triangle are 51.85° , 90° and 38.15° . The limestone blocks of the Orion pyramids consist of mostly calcite mineral, possessing an octahedral structure. Each of the Giza pyramids is apparently designed as the top half of an octahedron, accurately reflecting the microcrystalline structure of calcite crystal on the monumental scale. The refraction of *light* through calcite crystals encoded by the quadratic equation $[Z_{n+1} = Z_n^2]$ informs the refraction pattern of *infrasound* wavelengths through the giant pyramids (3.8).

The pyramids' limestone blocks contain crucial information regarding the construction methods of the pyramid builders. Research by J. Davidovits into ancient geopolymers has demonstrated through chemical X-ray analysis that the casing stones of the Giza pyramids are synthetic, being of lighter density than any quarried stone due to trapped air bubbles and consisting of 85-90% calcite with other exotic mineral constituents like opal-CT, hydroxy-apatite and silico-aluminates.¹⁶ CAT-scans of the core stones of the Great Pyramid have revealed hairs deeply embedded in the matrix of the stone, another clue that the pyramid blocks were cast using liquid stone, though RC¹⁴ dating of hair samples contained in the stone have not been reported. This type of test could establish accurate construction dates for the stones, although the likelihood of later facade reconstruction is strong. Corroborating ancient evidence of the use of advanced geopolymers has been documented in Mesopotamia's synthetic basalts.¹⁷



3.9. Cross-section of nonlinear standing waves (in pink) and their acoustic pressure distribution pattern (in blue)

Recent acoustic resonance experiments have illuminated a connection between the phi ratio and the nonlinear structure of standing acoustic waves. Cervenka, Bednarik and Konicek¹⁸ at the Czech Technical University in Prague have modeled the structure of nonlinear standing waves excited in a cylindrical resonator. Driven by periodic oscillations a resonant cavity can be stimulated to its fundamental resonant frequency producing both harmonics and subharmonics. When the standing wave is driven into high amplitude the nonlinear effects couple energy from low to high-frequency modes. This increase in harmonics can create a shockwave, diminishing the quality of the resonator dramatically. Multi-frequency driving of the resonant cavity has been used to increase energy storing in the system. If the energy is coupled to lower frequencies, or subharmonics, less acoustic dissipation is observed allowing for a more efficient system. Bednarik describes Resonant Macrosonic Synthesis:

[T]he interactions of acoustic waves at some fixed frequencies without the energy losses in the higher harmonics is of considerable interest in acoustics. Such interaction creates the possibility of direct transformation of coherent sound at the given frequency by sound of another frequency without an electromagnetic energy source... For a region of three modes with given angular frequencies, if the sum of two of them is equal to the remaining one [reflecting the Fibonacci ratio], the interactions of these modes can be obtained from the nonhomogenous Burgers equation for nonlinear standing waves.¹⁹

These findings inform an understanding of the three-pyramid design of Orion as resonators of three base frequencies, thereby generating subharmonics to store vast amounts of energy in Earth's atmosphere.

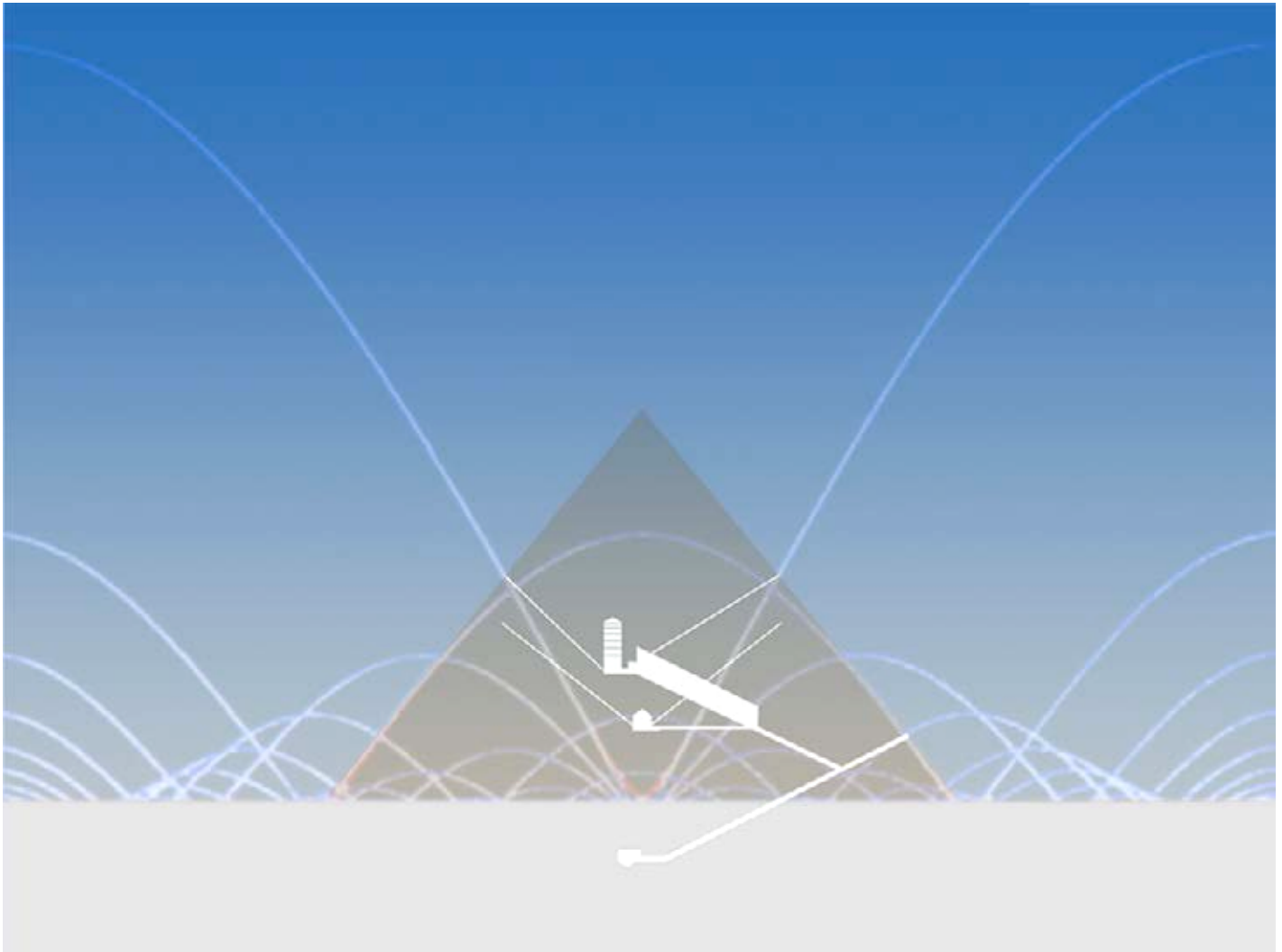

3.10. Nonlinear standing waves define the Great Pyramid's design function and resonant chamber alignments

The phi ratio describes the relative proportions of the three frequencies used to stimulate the nonlinear standing wave, such that the sum of two of the wavelengths equals the third (e.g. 20Hz, 30Hz, 50Hz). Fibonacci order is also observed in the distribution of acoustic pressure of standing waves along the resonant cavity (3.9). This standing wave structure informs the phi geometry of the Orion pyramids, as revealed by the superimposition of the pattern onto a cross-section of the Great Pyramid taken along the north-south axis (3.10). The high-amplitude transduction of the piezoelectric limestone blocks of the pyramids generates a strong electromagnetic field around the structures. A tri-frequency infrasound resonance continually generated in the base chamber of the Great Pyramid would take about 4 hours to circle globe and return to the pyramids, thereby generating standing waves after the initial build-up.

Each face of the pyramid distributes the electric charge as it alternates between negative and positive. The base length dimension of the Great Pyramid informs the fundamental resonant tone created by the structure. Each base side has been roughly calculated at 765', creating a fundamental frequency of 1.45 Hz when the pyramids are stimulated into high amplitude. The periodic pulsation of the pyramids at full operational capacity creates a Fibonacci standing wave resonance of subharmonics of the 756' wavelength bounded by the base of the pyramid. The angles of the standing waves exactly correspond to the slope of the pyramid's faces, showing the phi angle of 51.85° . This psychoacoustic baseline frequency of 1.45 Hz has been shown to induce the *tri-thalamic* synchronization of the hypothalamus, pineal and pituitary gland with the heartbeat. This frequency is also the lowest frequency of Schumann Resonance, thus the function of the pyramids may indeed be to shift the fundamental frequency of the Earth down from its fluctuations near 7.3 Hz to the tri-thalamic frequency of 1.45 Hz.

This pyramid heartbeat resonance network is recognized collectively as a solid-state global oscillator that functions in wavelengths of pure consciousness itself, entraining the human mind through redistribution and focusing of the planetary infrasound fields. Indigenous cultures across the globe recognize the Earth as a sentient being in itself. Just as consciousness has a frequency that can be measured by the electroencephalogram (EEG), the frequencies of Schumann Resonance can be understood as the vital pulse of Earth. The ancient wisdom passed on through the traditions of the Yaqui and Toltec cultures of present-day Mexico overtly describe the Earth's emanations and the corresponding alignment of the emanations of humans,²⁰ a natural process reported by scientists as the Frequency Following Response. Modern quantum biology and nonlinear acoustics now possess the tools to comprehend the seemingly abstract concepts of indigenous cosmovision in quantified terms. The octagonal structure of Earth's field of consciousness is quantified in this work –the very shape of the collective consciousness to which sentient beings attune themselves. The Orion pyramids' output likely induces a shift in the fundamental frequency of the Earth down to the lowest resonant frequency of 1.45 Hz, allowing a parallel shift in the capacity of human consciousness. Yaqui knowledge keepers precisely describe this shift in the alignment of the perception of man as an awareness of previously inaudible frequencies of infrasound:

[T]he portion of the emanations inside man's cocoon is in there only for awareness, and that awareness is matching that portion of the emanations with the same portion of emanations at large. They are called emanations at large because they are immense... inside man's cocoon the unknown is the emanations untouched by awareness. When the glow of awareness touches them, they become active and can be aligned with the corresponding emanations at large. Once that happens the unknown is perceived and becomes the known.²¹

The alignment process allows a heightened perception of otherwise inaudible infrasound, demonstrated by indigenous teachings as the key to understanding the unknown –phenomena that remain for the misaligned masses of humanity as 'paranormal' events. Indigenous knowledge of environmental processes that enhance human sensory perception was employed through the psychoacoustic driving of the Earth's atmosphere to achieve the synchronous heart beating of the entire human population in the network. This global entrainment pattern produced synchrony in the thought patterns of millions of human beings in collective tri-thalamic entrainment at 1.45 Hz. Synesthetic awareness induced by the infrasound network of enhanced consciousness is an activation of the Sanskrit *third-eye chakra*, at the center of the skull, being *the pineal gland itself containing biomineralizations of calcite microcrystals*.²²

The enhanced psychoacoustic conditions generated by the prime infrasound pyramids of Giza enabled the genetic changes that are observed in Pharaohs of Egypt who appear to have reserved exclusive use of the pyramids' internal chambers. The Pharaohs wore the headdress seen in the monumental Sphinx that retains the ancient sacred symbols of the much older society that originally constructed the Orion pyramids. The cobra hood is a *kundalini* symbol well known from ancient Sanskrit traditions, while the *third-eye pyramid* symbol originates from the same ancient source. The pre-Egyptian origin of these symbols will be demonstrated in further chapters in the context of Archaic Sanskrit artifacts from all parts of the world, yet the bare walls of the interior chambers at Giza confirms the functionality of *planar* stone.

The internal chambers of the Great Pyramid are constructed of huge rose granite blocks cut with precise right angles and perfectly planed faces, brought from the nearest granite quarry in Aswan directly to the south. The surface of the stone is covered in a thin glaze of quartz, the main constituent of granite, which is typical of a stonecutting technique now known as *thermal disaggregation*. Ivan Watkins, Professor of Geosciences at St. Cloud State University in Minnesota,²³ has designed a 'solar powered focusing and directing apparatus for cutting, shaping, and polishing', U.S. Patent No. 4,611,857 (1986) for the thermal disaggregation of stone. The lightweight unit is a parabolic reflector that focuses only a few hundred watts of light into a 2mm point capable of melting granite at a 2mm depth upon each slowly repeated pass. The notes of Garcilaso de la Vega have described the findings of the Conquistadors upon arrival in the Andes, detailing the Incas' large gold-covered parabolic stone bowls over 10' in diameter which were destroyed and processed into ingots. Strong similarities exist between the polygonal stonemasonry of the Andes and the pre-Egyptian Giza region; specifically the common surface glazing of quartz and perfectly rendered complex geometries, suggesting an identical advanced technology was used in the complex stoneworks of both continents –capable of melting quartz at temperatures of over 3,000°F.

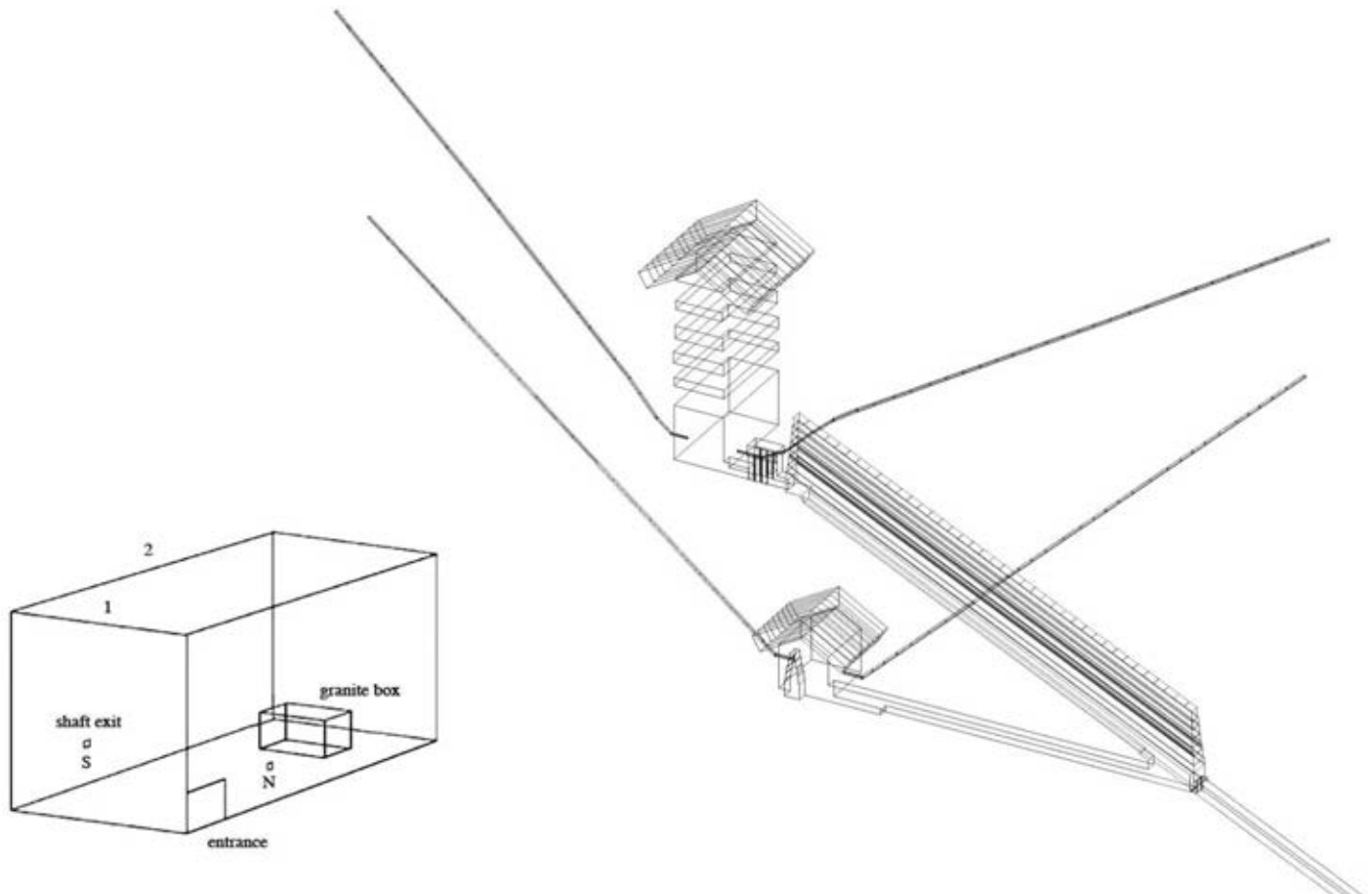

3.11. Chamber and air shaft alignments of the Great Pyramid, and the 1:2 ratio of the upper chamber (at left)

Rose granite was used in the construction of the internal chambers for its highly resonant properties. The quartz matrix of the granite stones is like a hall of mirrors with billions of parallel faces reflecting energy. The effect of this encasement in granite is that the airtspaces can be given harmonic dimensions to specify the wavelengths that will resonantly store acoustic energy in standing waves. The dimensions of the upper chamber reflect a 1:2 ratio (3.11), allowing three Fibonacci-proportioned frequencies to form standing waves. Acoustics engineer J. Reid carried out cymatic experiments revealing the resonant frequency of the upper chamber to be 121 Hz. Resonance in the upper chamber's granite box (erroneously dubbed the 'sarcophagus') was found at 117 Hz.²⁴ The interaction of these slightly offset resonant frequencies was most strongly felt while inside the granite box, creating a resounding beat frequency that closely matches the 1.45 Hz human heartbeat. Reid's subsequent research into human heartbeat rhythms revealed that the beats recorded in the granite box *matched exactly those of newborn infants*. As the heart rhythms of an individual change in the course of aging, an adult's heartbeat may be entrained through the acoustic beating of the granite box to imitate the measured heart rate of an infant.

The Institute of HeartMath has shown a regulated heart rate to be crucial to the formation of coherent electromagnetic fields around the heart, and to allow intentional relaxation of the DNA helix that is associated with positive emotions. The direct correlation between the stimulated beat frequencies of the granite box and a healthy infant heartbeat suggest the chambers' design purpose. As the effect is caused by the interactions of the slightly offset resonant frequencies of the upper chamber (121 Hz) and the granite box (117 Hz), the dimensions of both have most likely been calibrated to the heartbeat of a healthy newborn. By design, the low human voice creates a resonance in the upper chamber that entrains a tri-thalamic heartbeat rhythm in newborn infants. The granite box may have been a natal bath, the water's surface rippling in beautiful cymatic wave patterns to be broken by the first breath of the newborn. The damaged corner of the granite box denies its ability to hold liquids, suggesting a purposeful destruction, as is the case with many other granite boxes discovered in looted pyramids.

Rather than a tomb for the dead, it appears the upper chamber and granite box were designed and used as a nativity center for synchronizing the biorhythms of the mother and child during their physical separation after birth. The ratio of the dimensions of the upper chamber, *one to two*, can also be considered a mathematical or acoustical symbolism *for separation, from one to two bodies*. Physical evidence that the chambers were designed for this purpose was discovered during early twentieth century investigations of the ascending shafts. A carved stone tool was found sealed in one of the ascending shafts of the mid chamber. The artifact is interpreted to be a *peshesh khaf*, used in ancient times to sever a newborn's umbilical cord in the physical act of severing the child from the mother.

The ascending shafts are directly aligned to the geographic north and south poles, having been specifically designed as receivers of the lowest frequencies of infrasound at 0.5 Hz that align precisely to the shaft exits (3.6). The changes in angle of the oblong rectangular shafts are subtle and intriguing, affecting the propagation of sound in ways that are not yet understood. The location of the natal tool in the ascending shaft suggests a resonant function also related to the biorhythmic entrainment of a newborn infant. The dimensions of the 6' long horizontal portion of the shafts are just the right size to be able to accommodate a small newborn lying down. It then seems likely that the shafts were designed to focus a resonance of ultra-low infrasound waves upon a newborn placed in the shafts openings in the upper chamber. As there are two shafts ascending from both the upper chamber and the lower chamber, even twins could be accommodated in a natal entrainment ritual involving psychoacoustic resonance. The cranial augmentation observed of ancient Egyptian royalty may be a direct result of fetal gestation and natal biorhythmic entrainment at the Great Pyramid. The complete set of angles of the internal chambers and the pyramid entrance are clearly aligned to the nonlinear network of infrasound standing waves transduced through its finely planed crystalline stonemasonry.

A balanced, full-spectrum infrasound environment has been shown to stimulate both emotional relaxation and DNA helical structural relaxation, called 'denaturation'. Acoustic research in Russia has demonstrated a nonlocal mode of DNA communication through an omnipresent field.²⁵ The interaction has been described as holographic and based on nonlinear coupling of DNA with electromagnetic fields, a topic to be expanded upon at the conclusion of this chapter. As the first months after birth are well known to be developmentally influential, perhaps exposure during and after birth to the full infrasonic range may increase DNA development inducing synesthetic consciousness. While the Egyptians may not have built the pyramids, they certainly applied kundalini techniques in using the psychoacoustic architecture. The cranial volumes of the Pharoanic families were extraordinary, most notably that of Akhenaton, Nefertiti and their children (3.8, right). Unusually elongated crania have been observed in statuary depictions of even the youngest children, leading to an assumption that it was a genetic trait. Perhaps, in light of the new acoustical data from the Great Pyramid's chambers this assumption may be confirmed and understood to be a result of the infrasonic stimulation, the advanced art of genetic enhancement. The elongated skulls of the ruling families of ancient high civilizations may have been developed through gestational entrainment techniques under the Great Pyramid's magnetic umbrella.

The stepped pyramid-building cultures of South America which were contemporaries of the Egyptian culture began their traditions approximately 5,000bp in Caral, Peru and elsewhere, having constructed monumental temples throughout the Andean region. These cultures used a very similar visual symbolic language, metallurgy and ritual tradition as those of Dynastic Egypt, including the elegantly elongated skulls of their ruling classes (3.8, left). Perhaps the royal lineages of pyramid building societies had access to the advanced psychoacoustic cranial augmentation chambers, while their subjects only imitated the divine appearance by the manual practice of cranial deformation using wooden boards. While cranial deformation is a worldwide cultural tradition, having been observed on every inhabited continent, there are no known living examples of symmetrically augmented crania displaying the dramatically increased brain volume, present only in those of high status in ancient cultures of 5,000bp.

Skulls having been 'deformed' through the imitative cultural traditions still practiced today display significant differences with those of royal status acoustically enhanced in ancient times. The blood vessel patterning on the interior cranial walls reveals the extent of unobstructed brain development. Deformed



3.12. Andean elongated skull is identical to a granite portrait of Meritaten, one of the daughters of Queen Nefertiti

skulls show the affects of growth-inhibiting internal pressure on the developing brain which results in asymmetry, incomplete knitting of the sutures between the cranial bones and aberrant blood vessel formation. These are common characteristics of hydrocephalic skulls, caused by the detrimental internal pressure of excess fluid in the developing skull. These well-known characteristics of deformation are absent in many skulls that have been excavated in Egypt, Mesoamerica and the Andes, thought to be individuals of royal status. A distinct similarity is apparent when one compares both the elegant cranial elongation and the decorative headdress style of the royal families of Egypt and the Andes. Further evidence supporting the notion of shared cultural traditions between the ancient Egyptian and Andean ruling classes are the high levels of Andean tobacco and cocaine found in Egyptian mummies, overwhelming demonstrated by hair shaft sampling of hundreds of ancient mummies in a comprehensive survey by toxicologists.²⁶ Drug trafficking is direct evidence of significant intercontinental transport, suggesting that the symmetrically elongated skulls of the royal lineages of the Andes may also have been achieved through psychoacoustic nativity practices in resonant stone chambers as in Egypt.

Reid also preformed cymatic experiments by stretching a plastic membrane over the upper chamber's granite box to act as a vibrating platform. Upon the membrane fine quartz sand was sifted evenly. As an oscillator in the granite box below the membrane produced a steady tone, the induced vibration of the membrane separated the sand into troughs and piles, revealing the structure of the standing waves created. Incredibly, Reid's photographs of the patterns formed on the membrane through the stimulation of various frequencies bore an uncanny resemblance to several Egyptian hieroglyphic inscriptions. The interrelationship of human consciousness, psychoacoustics and language is becoming clearer through the study of acoustic resonance and the cymatic patterns that are formed by standing waves.

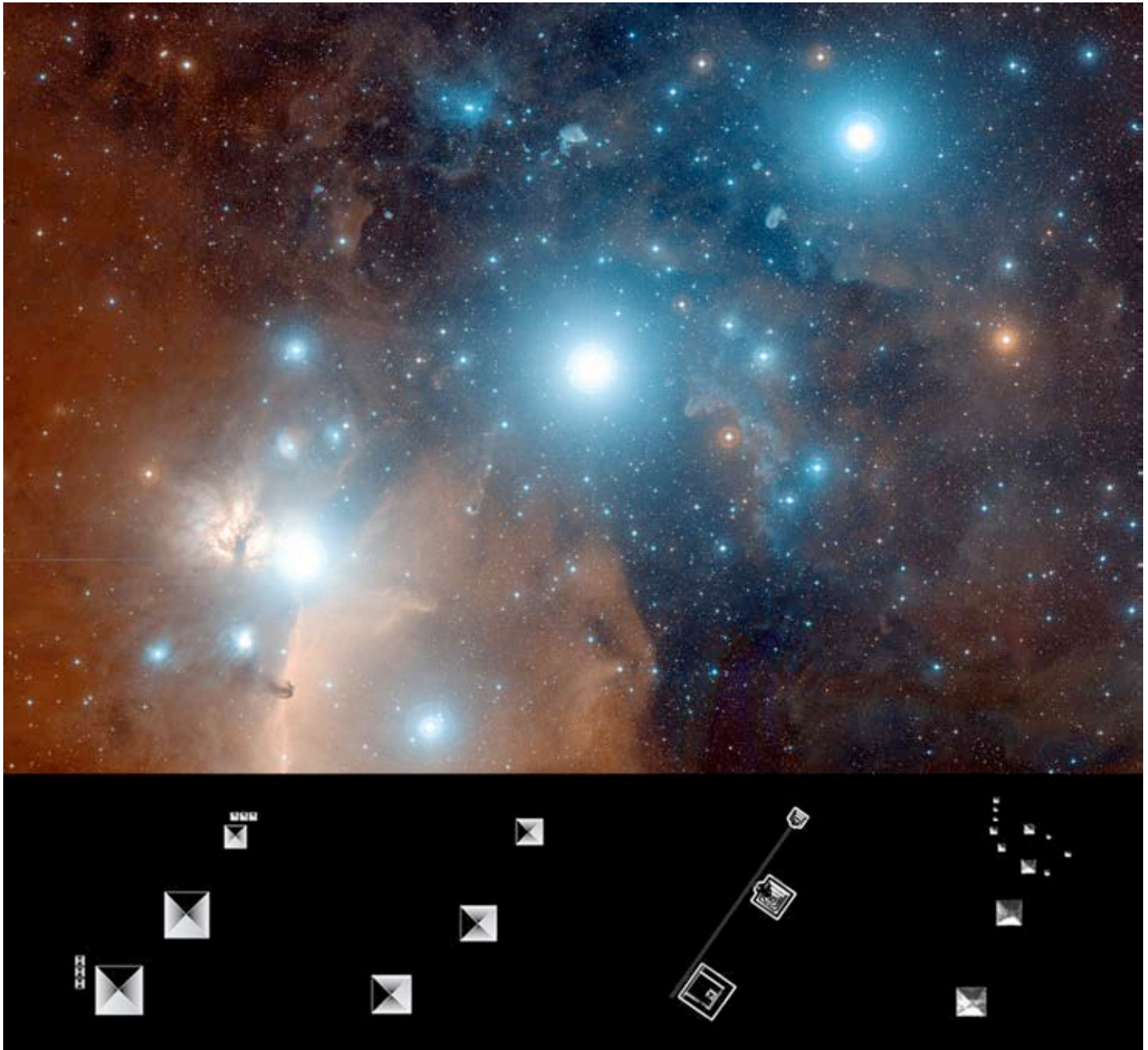

3.13. Orion's belt constellation symbolism of the pyramids at Giza, Montevécchia, Teotihuacan and Xi'an (left to right)

The most repeated symbolism observed in ancient pyramid design is the three star belt of the Orion constellation (3.13), presented in the layouts of pyramid sites at Giza, Egypt; Montevécchia, Italy; Teotihuacan, Mexico; Xi'an, China; as well as in the temples of Borobudur, Indonesia. This pattern is not only symbolic of stellar alignments, but also displays fractal self-similarity in the octahedral form being repeated at three different sizes. The overwhelmingly synchronous information encoded in the ancient sites and cultural traditions in alignment all over the globe is understood as the fabled Hall of Records; having successfully transmitted the hidden legacy of humanity to which we are all awakening.

Recent research in Russia led by quantum biologists Gariaev and Poponin has thoroughly described the 'DNA phantom' effect,²⁷ which is in essence a residue of consciousness. By using periodic laser pulses the researchers have observed luminal alignment to DNA in a vacuum, which remains for even weeks after the DNA has been removed from the chamber. The conclusion has been that the luminal alignment is the DNA exciting a previously unrecognized nonlocal energy field, to which the bounds of

three-dimensional space-time do not apply. Their central conclusions from explorations of the vibratory behavior of DNA: "Living chromosomes function just like a holographic computer using endogenous DNA laser radiation."²⁸ The research has led to new acoustic devices which can actually transmit patterns of DNA from one stand to another, allowing the scientists to even transform a frog embryo into a salamander embryo using only sound! All of the problems encountered in gene sequencing have been overcome, while the limits of the new technologies are not yet known. The newly discovered communications of DNA provide the quantitative measurements that reveal the links between Earth resonance and DNA states in nonlinear acoustics. Dr. Poponin states his own understanding of the newly revealed quantum connections that would be integral to a unified field theory:

These experimental data provide us not only quantitative data concerning the coupling constant between the DNA phantom field and the electromagnetic field of the laser light but also provides qualitative and quantitative information about the nonlinear dynamics of the phantom DNA fields. Note that both types of data are crucial for the development of a new unified nonlinear quantum field theory, which must include the physical theory of consciousness and should be based on a precise quantitative background.²⁹

Quantum physics and nonlinear acoustics now can be applied to understand the dramatic changes that are now occurring in human consciousness, global weather and geologic activity as related to the magnetic polar reversal already in progress. The new orientation of the geographic and magnetic poles will reflect a new alignment of planetary resonance and a new consciousness as DNA responds. The phenomenon of synesthesia, the cross wiring of the senses where one can smell a color and see a sound, may be a manifestation of increased perceptual ability spreading through the population of humanity in response to the changes occurring in the acoustic environment. A comprehensive study of the population distribution patterns of living individuals with synesthesia will reveal congruence between measurements of infrasound resonance and the corresponding effects of enhanced consciousness.

Ancient indigenous cosmology provides a model of human consciousness as cyclical, that humanity was once an interplanetary being that has now been entangled in the physical world. The Mayan Tzolkin calendar's 2012 completion may be considered a link to the knowledge of the ancient Sanskrit mother-culture whose legacy of four-dimensional mathematics still echoes through stone today. Mayan and Inca prophecy foretell of the close of this grand cycle and the return of Earth to a higher resonance that will be maintained throughout the next grand cycle to come. The Precessional calendar is estimated at 2,150 years per Age, for each of the twelve signs of the zodiac, as we now enter Aquarius. One complete Precessional cycle is 25,800 (2,150 x 12) and twelve Precessional cycles completes a Grand Precessional cycle of 309,605 years (25,800 x 12, reflecting $F\#138 \times 10^{-23}$).

In genetic research, this time period of around 300,000 bp has also become significant as the 'last common denominator' for all modern human ancestry. While four-dimensional physics aims to comprehend the Earth's field of consciousness, the deep mystery of human origins seated in our genes remains veiled. The records kept in our genes may be the best evidence to look for cyclical alterations in genetic expression that may be the result of changes in the state of the planet's magnetic field. Perhaps the ultimate question of human origins is the very one answered by the repeated temple design of Orion's belt. The Orion star system itself may be the indigenous home of the cosmic civilizations from which humanity on Earth descends.

The notion that fluctuating planetary energy levels are reflected in the consciousness of man is found throughout ancient cultures, often associated with water. Water's ability to store geometric energy patterns has been likened to *memory*, and indeed the pyramid-building Maya culture teaches a duality between terrestrial waters of forgetfulness and celestial waters that strive to remember. The sacred calendars of the Maya describe the cycles of interaction between Earth and the other planets of the solar system as defining the duration of whole civilizations. This suggests there may be a connection between the resonance of various planets by their exchange of water. The legendary cataclysmic end of the Atlantean civilization is described all over the world as the Great Flood that raised water levels by *hundreds of feet, flooding vast portions of the globe*. Where would this water have come from? Mars, the Earth's nearest neighbor, shows evidence of liquid water once flowing on its surface, yet cannot be found today.

Water samples held in rocks from Mars contain high levels of deuterium or *heavy water*, a low-resonance isotope of hydrogen with an extra neutron. Water on Earth contains trace amounts of deuterium at only one fifth of the levels observed of the waters of Mars. It seems then quite likely that the ancient Great Flood was an inundation of Earth's atmosphere with deuterated water ice from Mars that left the red planet barren and dry and the blue planet contaminated. This may also inform the ancient association of Mars with *war* as a result of the negative influence of low-resonance water on human consciousness and physical aging, rather than being simply related to the planet's blood-like color. By contrast, antediluvian pyramid sites likely energized water to extract pure *protium*, the essential form of hydrogen (with one neutron). The pyramid culture is thus designed to use the crystalline memory of celestial waters to awaken human divinity at sacred temples like Teotihuacan, meaning '*site-where-man-becomes-God.*' The resonant frequency of the Pyramid of the Sun at Teotihuacan closely matches the 1.45 Hz heartbeat oscillation of the Great Pyramid due to its comparable base length of 740'. Itza Mayan Elder Hunbatz Men describes the pyramids as generators of *the brilliant light of heaven that imbues the human being with eternal life:*

Cosmic Creator Hunab K'u guides the initiatic work of the Mayan Elders at their sacred pyramids:
"Take care of the light that I leave within my temple. When you form the human being, teach him to venerate my house, for within it they will find the light they need for eternal life. Teach him also that if he should stray, due to his errors, vices or ignorance, then I, Hunab K'u will reclaim my beloved beings and take them to my temple of wisdom and nourish them again with my light which is in the heavens. Then, together, Tepeu, Gugumatz and Huyubcaan will perform purification rituals using that brilliant light for the benefit of my beloved whom we created and molded, so they can live in the light of eternal wisdom."³⁰

The concept of a special life-giving light radiating inside pyramid chambers is also related in hieroglyphic texts inscribed on the interior walls of the pyramids of Saqqara, Egypt. Profound details of the luminal and acoustic effects of the Great Pyramid transducer in full operation have been recorded in stone:

House bright and dark of Heaven and Earth, for the [solar] ships put together; Great Pyramid, House of the gods with pointed peak; for Heaven-to-Earth it is greatly equipped. House whose interior glows with a reddish Light of Heaven, pulsating a beam which reaches far and wide; its awesomeness touches the flesh... House of Eternity: its foundations are stones, the water; its great circumference is set in the clay. House the rightness of whose howling the Great-Ones-Who-See-and-Orbit bring down to rest... Mountain by which Utu ascends... whose deep insides men cannot penetrate.³¹

These enigmatic passages use such simple language to directly express the purpose of the pyramids, informing the reader that the "interior glows with a reddish Light of Heaven, pulsating a beam which reaches far and wide," interconnecting pyramids in all parts of the world. Both the Egyptians and Maya describe this "reddish Light of Heaven" as suspending the aging process of the human being as it "touches the flesh." The description of the narrow shafts within the pyramid as "deep insides men cannot penetrate" is likely a reference to being used in the psychoacoustic development of infants, being the perfect size to accommodate a newborn after water-birthing processes. The text describes water as part of the foundation of the Great Pyramid stones, confirming the original presence of Lake Hathor surrounding the pyramids. The powering of aerial vehicles –*solar ships*– is also stated as part of the design function of the pyramids, *whose "howling" was quieted by beings in Earth orbit.* This is perhaps the most intriguing statement, confirming that the pyramids generated ultra low frequency oscillations as well as a reddish beam of light when in operation, *and that the Great Pyramid's operation was halted by extraterrestrial beings observing humanity from orbit!* This intriguing extraterrestrial dimension of the Atlantean civilization will be further discussed in the broader context of various archaeological finds from around the globe that depict the extraterrestrial beings whose influence silences the Great Pyramid.

The word 'pyr-a-mid' itself is of Greek origin, based on the word 'pyros' or fire, and meaning 'fire in the middle'. Did hydrogen plasma derived from water once burn in the inner chambers of the world's pyramids? The recently rediscovered high-energy state of hydrogen has been reported by Dr. Randall Mills, who has developed the process that releases vast amounts of energy stored within the hydrogen atom itself.³² Mills has defined the physics underlying this novel chemical reaction derived from water as *hydrino resonant-transfer plasma* that is generated in vacuum chamber reactors now being commercially marketed for power generation by his company Blacklight Power, Inc.



3.15. Hydrino resonant-transfer plasma developed by Blacklight Power

The Blacklight Power researchers have defined the atomic process by which hydrino plasma forms (3.15). Hydrogen gas is produced by the electrolysis of water and is heated in a vacuum chamber with metal particles. The metals become vaporized and bombard the H atoms causing them to shrink to one-quarter normal size in a chain reaction that generates hydrino plasma. Potassium or various other elements are used to catalyze this implosive chemical reaction that releases vast amounts of energy in the form of ultraviolet and infrared light radiated by the shrinking of hydrogen atoms. This plasma reaction can occur in open air, but is more efficiently generated in a vacuum chamber.

This resonant-transfer process of hydrino plasma vastly exceeds the energy output of combustion reactions and is fueled by the most abundant element in the universe. The *explosion* principle behind the combustion reaction is reversed in the hydrino plasma reaction, based instead on the principle of *implosion*. Hydrino plasma was an essential component of the resonant energy production of the world's pyramids; having generated intense infrared and ultraviolet radiation within the vacuum chambers of acoustically charged piezoelectric monuments. Plasma has a resonant crystalline structure like calcite and quartz enabling transduction of focused atmospheric infrasound into heat, light and strong EM fields.



3.16. Klein demonstrates the cold HHO torch tip

A very similar application of this atomic reaction of hydrogen has been developed by Denny Klein, called HHO gas, and is now available as a plasma torch capable of sublimating any material.³³ Klein's two-gas oxygen-hydrogen mixing process uses the same simple torch heads developed for the inferior oxygen-acetylene process, yet Klein's H₂O-2000 generator *burns water* (3.16). The over 6,000°F temperatures obtained by the combustion of oxy-acetylene are far surpassed by the HHO plasma that produces a variable BTU energy output. Temperatures as high as 10,000°F are generated when the HHO plasma comes into contact with metals like Tungsten. Conversely, HHO plasma making contact with the open air generates temperatures of only 259°F. Once again, the differing behavior of the two processes reflects the essential difference between the explosion principle of oxy-acetylene and the implosion principle of hydrino plasma. The utility of the implosion reaction far exceeds that of combustible gases, exhibiting an extremely high power-density, low pressure and stable nature that is both more efficient and significantly safer than normal combustible gases. The hydrino plasma reaction produces intense infrared and ultraviolet light. Interestingly, the bandwidth of UV radiation produced is restricted to UV-A, while the destructive UV-B and UV-C wavelengths are not observed. The UV-A and IR radiation of HHO plasmas are completely safe for the eyes.

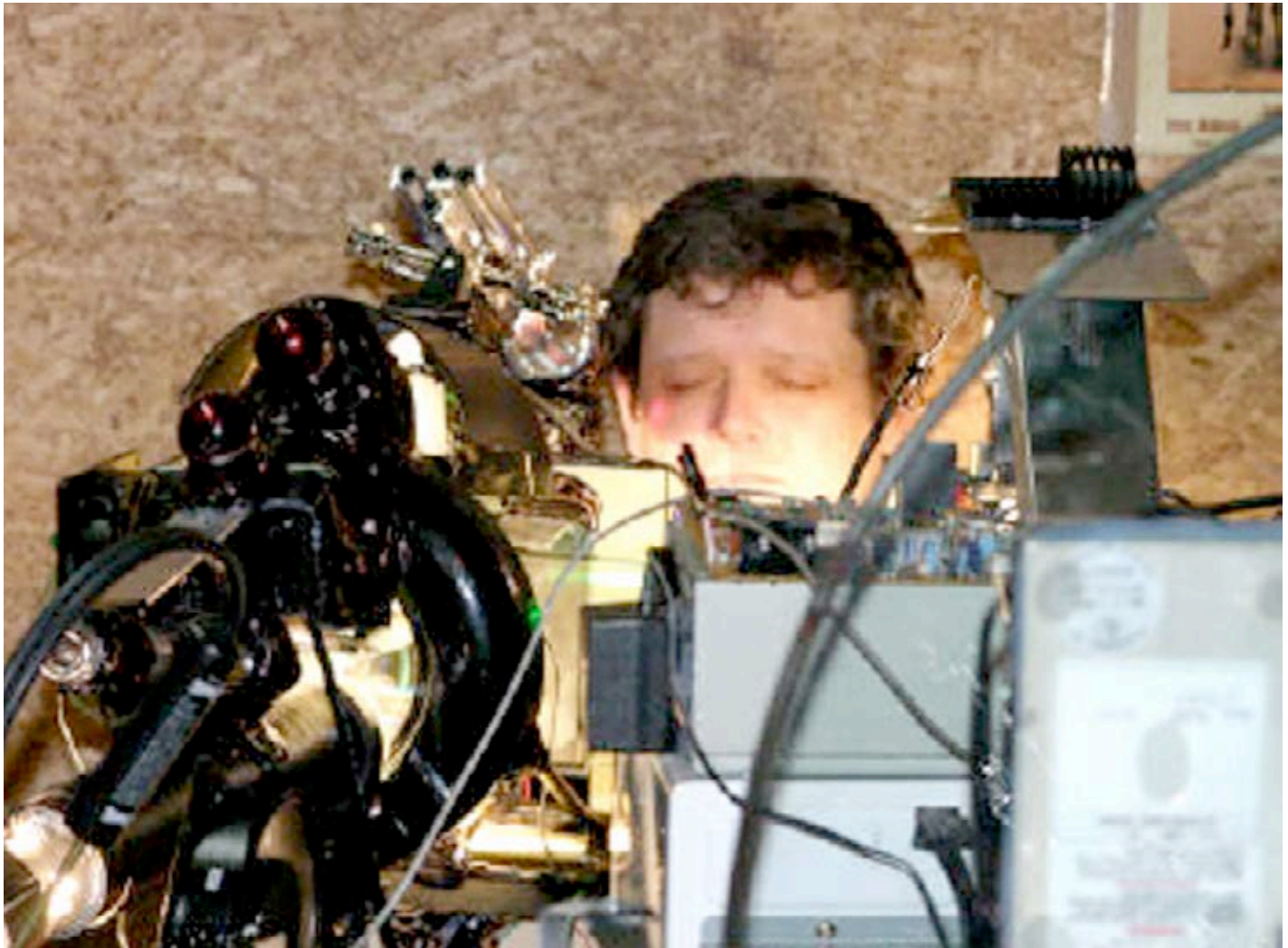

3.17. Biophysicist receives a *light healing* from the 'God Light' plasma-beam device constructed by Troy Hurtubise

The first patents for an electrolyzer that produced the hydrogen/oxygen gas mixture were granted to William Rhodes in 1962. Early developments of water plasma torch technology used a mixture of monoatomic and diatomic hydrogen and oxygen as well as water vapor—a mixture referred to as Brown's Gas after inventor Yull Brown who patented his designs in 1974. The Watertorch developed by George Wiseman generates this type of mixture and has been available for purchase since 2001.³⁴ It wasn't until the work of Dr. Randall Mills that the physics of the implosive shrinking of atomic hydrogen to become a hydrino was explicitly identified as the source of the great energies released by the plasma.

The hydrino plasma reaction provides comprehensive insight into the ancient knowledge of the Maya and Egyptian cultures, whose descriptions of the plasma generation within the pyramids have bewildered historians without any knowledge of the high-energy states of the hydrogen atom. Statements from the deep past describing "*the pyramid's reddish interior glow as the Light of Heaven that grant eternal life*" are now comprehensible in the context of plasma physics. "*A beam of light whose awesomeness touches the flesh*" has been developed in the form of a healing device that projects resonant-transfer plasma onto malignant parts of the human body. Canadian inventor Troy Hurtubise has constructed a prototype plasma-beam healing device that he has named *God Light* for its remarkable stimulation of cellular regeneration in living tissues as verified by biophysicists from Germany and France who themselves have benefited from exposure to the regenerative plasma beam (3.17).³⁵ The regenerative effect of hydrino plasma reveals the remarkable design function of the world's pyramids as energizing water to generate radiant HHO plasma within the interior chambers, suspending the aging processes of the human body and engendering holographic consciousness by psychoacoustic synchronization.

References

- ¹ Reeves CN, Reeves N (1995) *'The Complete Tutankhamun: The King, the Tomb, the Royal Treasure'* Thames&Hudson
- ² Bauval R, Gilbert A (1995) *'The Orion Mystery'* Three Rivers Press
- ³ Hancock G (2004) *'BBC Horizon Scandal'* online · <http://www.grahamhancock.com/horizon/default.htm>
- ⁴ Robert S (1999) *'Voices of the Rocks: A Scientist Looks at Catastrophes and Ancient Civilizations'* Crown Publishing Group/Random House
- ⁵ Bauval R, Hancock G (1997) *'The Message of the Sphinx: A Quest for the Hidden Legacy of Mankind'* Three Rivers
- ⁶ Dunn C (1998) *'The Giza Power Plant: Technologies of Ancient Egypt'* Bear & Company
- ⁷ Mehler S (2002) *'The Land of Osiris'* Adventures Unlimited Press
- ⁸ Cadman J (2003) *'The Subterranean Chamber Water Pump and Pulse Generator'* online · http://great-pyramid-giza-pulse-pump.com/Research_Article_V41.html
- ⁹ Kruger A (2004) *'Construction And Deployment Of An ULF Receiver For The Study Of Schumann Resonance In Iowa'* online · http://www.ia.spacegrant.org/RES_INF/VRR2003/Kruger-SEED.pdf
- ¹⁰ Lipshitz R (2002) 'The Square Fibonacci Tiling' *Journal of Alloys and Compounds* 342, pp. 186-190
- ¹¹ Mauritsson J, Johnsson P, Mansten E, Swoboda M, Ruchon T, L'Huillier A, Schafer KJ (2008) 'Coherent Electron Scattering Captured by an Attosecond Quantum Stroboscope' *Physical Review Letters* 100, 073003
- ¹² Jadczyk A (2003) *'On Quantum Iterated Function Systems'* IFT University of Wroclaw internal report
- ¹³ Blanchard P, Jadczyk A (1993) 'Event Enhanced Quantum Theory and Piecewise Deterministic Dynamics' *Physical Letters A* 175, pp. 157-164
- ¹⁴ Blanchard P, Jadczyk A, Ruschhaupt A (1999) *'How Events Come Into Being: EEQT, Particle Tracks, Quantum Chaos, and Tunneling Time'* e-print archive quant-ph/9911113
- ¹⁵ Gugg C, Healy T, Maier-Paape HK, Maier-Paape S (2000) 'Nonlinear Standing and Rotating Waves on the Sphere' *Journal of Differential Equations* 166, pp. 402-442
- ¹⁶ Davidovits J (1984) 'X-Ray Analysis and X-Ray Diffraction of Casing Stones from the Pyramids of Egypt, and the Limestone of the Associated Quarries' *Science in Egyptology Symposia*, pp. 511-520
- ¹⁷ Stone EC, Lindsley DH, Pigott VV, Harbottle G, Ford MT (1998) 'From Shifting Silt to Solid Stone: The Manufacture of Synthetic Basalt in Ancient Mesopotamia' *Science* 280, pp. 2091-2093
- ¹⁸ Cervenka M, Bednarik M and Konicek P (2003) *'Nonlinear Standing Waves in Acoustic Resonators with Arbitrary Reflection Coefficients at Their Walls'* Czech Technical University, Prague
- ¹⁹ Bednarik M (2003) *'Modeling Nonlinear Standing Sound Waves in Cylindrical Resonators'* Czech Tech U, Prague
- ²⁰ Castaneda C (1984) *'The Fire From Within'* Simon&Schuster, pp. 204-207
- ²¹ Castaneda, op cit, p. 207
- ²² Baconnier S, Lang SB (2004) 'Calcite Microcrystals in the Pineal Gland of the Human Brain: Second Harmonic Generators and Possible Piezoelectric Transducers' *IEEE Transactions on Dielectrics and Electrical Insulation* 11, pp. 203-209
- ²³ Watkins I (1990) 'How Did the Incas Create Such Beautiful Stone Masonry?' *Rock and Mineral* 65
- ²⁴ Reid J (2002) *'Egyptian Sonics'* self-published
- ²⁵ Poponin V (2003) *'The DNA Phantom Effect: Direct Measurement of A New Field in the Vacuum Substructure'* Institute of HeartMath online · <http://homepages.ihug.co.nz/~sai/DNAPhantom.htm>
- ²⁶ Balabanova S, Parsche F, Pirsig W (1992) 'First Identification of Drugs in Egyptian Mummies' *Naturwissenschaften* 79, pp. 358-366
- ²⁷ Gariaev P, Poponin V (1995) 'Vacuum DNA Phantom Effect in Vitro and its Possible Rational Explanation' *Nanobiology*
- ²⁸ Gariaev P, Grigor'ev K, Vasil'ev A, Poponin V, Shcheglov V (1999) 'Investigation of the Fluctuation Dynamics of DNA Solutions by Laser Correlation Spectroscopy' *Bulletin of the Lebedev Physics Institute* 11-12, pp. 23-30
- ²⁹ Poponin V (2000) *'The DNA Phantom Effect: Direct Measurement of a New Field in the Vacuum Substructure'* Institute of HeartMath Report, online · <http://www.rialian.com/rnboyd/dna-phantom.htm>
- ³⁰ Men H, Yaxk'in AJ (2001) 'Mayan/Tibetan Prophecy' online · <http://www.lightworkarticles.info/MayanProphecy/>
- ³¹ Sitchin Z (1999) *'The Wars of Gods and Men: Book III of the Earth Chronicles'* Harper, online · http://www.bibliotecapleyades.net/sitchin/sitchinbooks03_03.htm
- ³² Mills RL, Ray P, Dhandapani B, Nansteel M, Chen X, He J (2002) 'New Power Source from Fractional Quantum Energy Levels of Atomic Hydrogen Surpasses Internal Combustion' *Journal of Molecular Structure* 643, pp. 43-54
- ³³ Rodgers W (2005) 'Clearwater Man Puts Technology to Work' *Tampa Tribune*, November 27, online · <http://www.human-resonance.org/hho.html>
- ³⁴ -- (2001) *'Buy a Watertorch'* Watertorch.com, online <http://www.watertorch.com/buytorch/buybg1.html>
- ³⁵ -- (2005) *'Angel Light Ascends to God Light, Part 2'* BayToday.ca, online · <http://www.baytoday.ca/content/news/details.asp?c=8271>

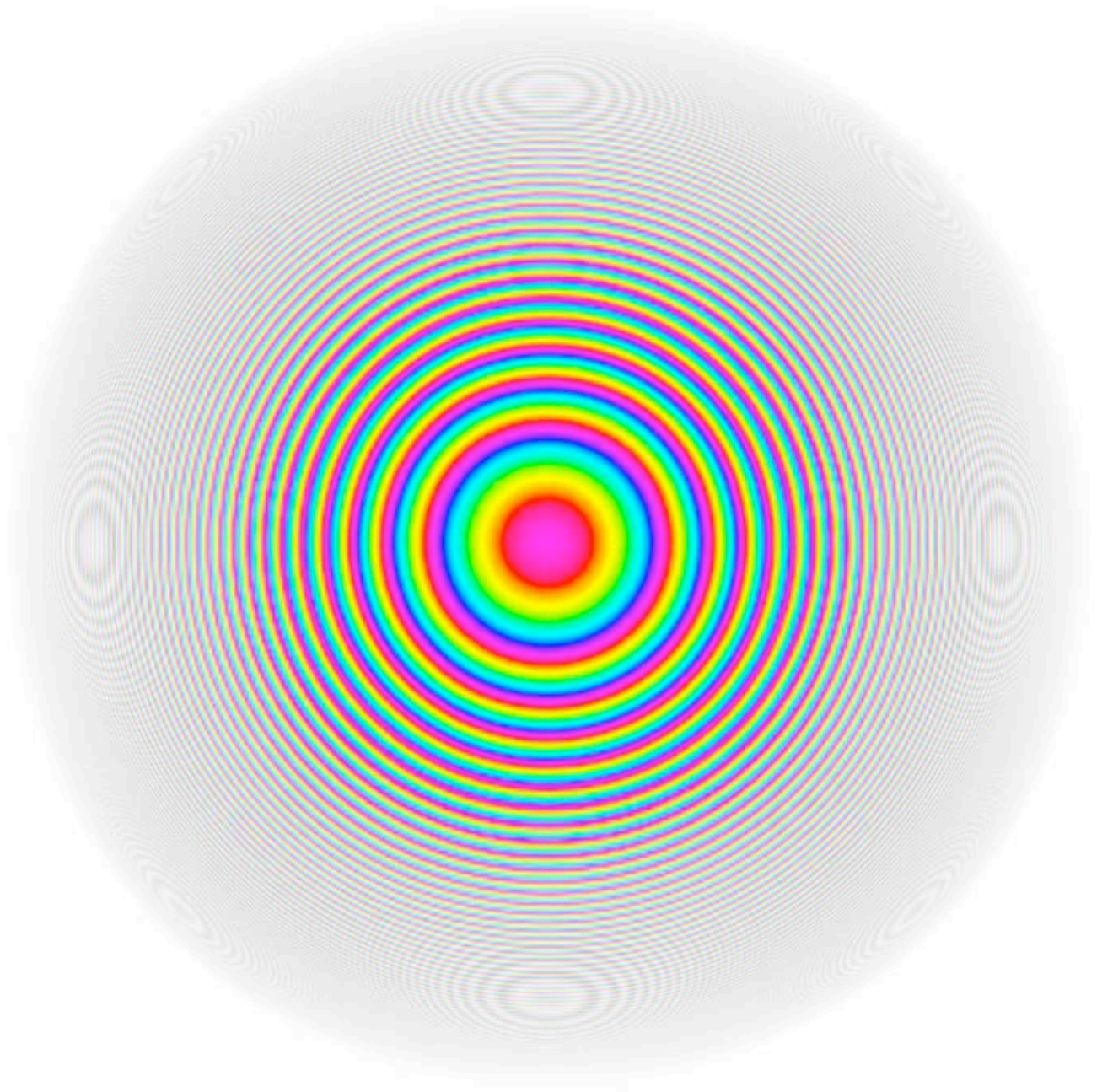

4

Magnetic Resonance

Magnetic Resonance

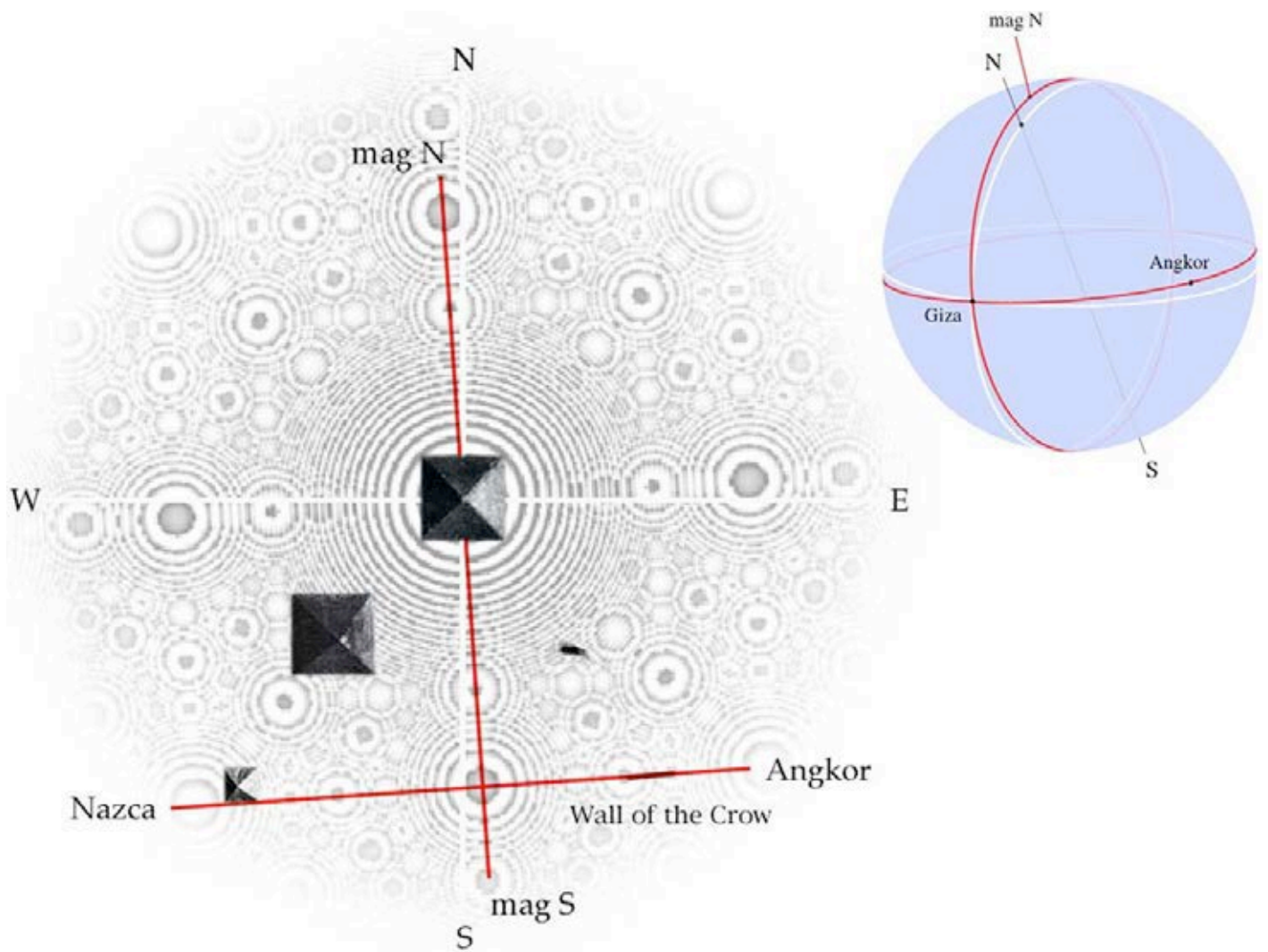

4.1. The Wall of the Crow presents the quadrupolar alignment to magnetic N (red), offset from geographic N (white)

The four faces of the Orion pyramids of Giza, Egypt have already been described in their quadrupolar phi angles facing the cardinal directions. This alignment to the geographic north and south poles forms a longitudinal circumference around the Earth along the modern 31°E and 149°W (in white, 4.1). This circle bisects the Earth into hemispheres marking the ancient prime meridian, 0° longitude. The location of Giza along this line is unique as it is the center of the landmass of Earth. The longitudinal circumference passing through Giza crosses the most landmass *above sea level* of any longitude, as does the site's latitudinal circumference from 30°N to 30°S. These unique site specifications for the Orion pyramids would last for millennia before the inevitable changes due to catastrophic tectonic subduction events that occur repeatedly, perhaps in concert with the cycles of glaciation and magnetic polar reversal. Giza is 16.7% or about $\frac{1}{6}$ of the Earth's circumference from the N pole along this ancient prime meridian. The work of Carl Munck provides astonishingly detailed numerical analyses¹ of the geometry expressed in the forms of the largest ancient limestone and granite architecture, revealing a geometric design code for specifying the exact global position in relation to Giza. Once Munck made the 31° prime meridian adjustment his efforts in decoding the numbers of presented by pyramid faces and other features were successful when using the same set of simple rules. The great complexity of the numerical codes contained in the specified geometries of ancient sites necessitates a thorough review of Munck's convincing demonstration that *all* ancient sites are oriented in relation to the Orion pyramids of Giza.

An aerial perspective of the Giza pyramids reveals the correlation of the Magnetic Resonance structure with the design plan of the pyramids and their geometric alignments to other ancient temple sites (4.1). To the southeast of the Sphinx, directly east of the smallest pyramid is the massive limestone wall that defines an angular alignment not observed elsewhere at the Giza complex. The Wall of the Crow is a 600' long by 30' high megalithic wall undercut by a portal with a lintel that is among the largest fitted stones on the Giza plateau. The interlocking masonry of this entrance to the Giza plateau is highly reminiscent of stonework found in the Andes, especially the megalithic site of Saqsaywaman, in modern day Peru near the ancient Inca capital of Cuzco. The gigantic Wall of the Crow does not share the pyramidal alignment to the geographic poles, but is angled 5° off from due east. The wall defines a division of two hemispheres along a great circumference around the Earth 'as the crow flies', passing through Giza's antipode in the Pacific Ocean at 30°S, 149°W. Along that straight-line path lie the Angkor temples of Cambodia to the east and the Nazca lines of Peru to the west, an alignment described as the Sine Wave of ancient sites (4.3). The Wall of the Crow begins and ends at nodal points of the Magnetic Resonance fractal mapping (4.1), revealing the intimate relationship between the invisible resonance patterns and the layout of the limestone pyramid complex at Giza. As well, its name is another psychoacoustic reference to flight and the sine wave pattern produced by the flapping of a bird's wings.

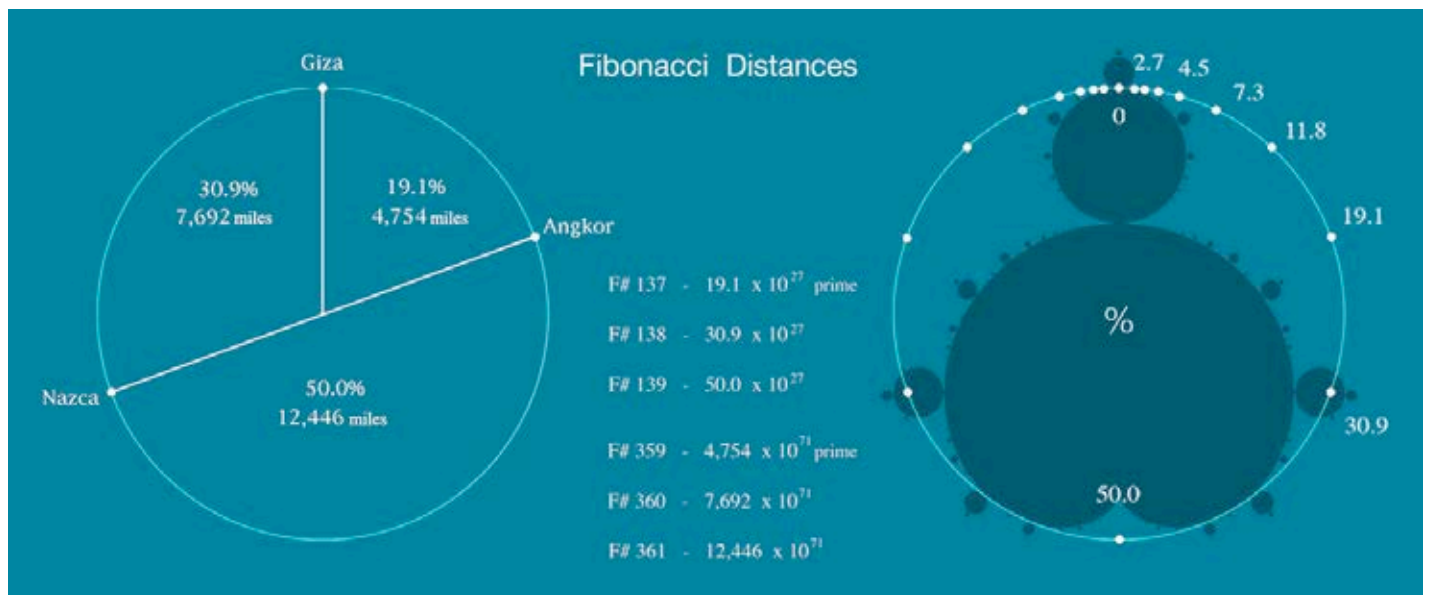

4.2. Fibonacci series correlations with the Sine Wave circumference distances of Giza, Angkor and Nazca

This Sine Wave circumference is one half of a quadrupolar alignment that is offset to the same degree as the Earth's magnetic North pole from the geographic N pole, the axis of Earth's rotation. An alignment perpendicular to the Wall of the Crow passing through the center of the Great Pyramid, at an angle offset 5° from due north, describes the pyramids' alignment to the magnetic North pole (in red, 4.1), which fluctuates position near 78.3°N 104.0°W in the Canadian arctic. The distance from the magnetic North pole to Giza in miles is identical to that of Giza to Angkor, both about 4,754 miles from Giza (F#359) along a pair of perpendicular circumferences quartering the Earth. These two intersecting circles of aligned sites define the axis of the quadrupolar standing waves described here as Magnetic Resonance. If a great circle is drawn around Giza passing through all of the points at this 19.1% distance from Giza, Angkor is exactly 25% of its circumference away from the magnetic North pole (4.2). This isosceles triangle of sites delineates the two prime meridians passing through Giza, at prime resonant distances.

The golden ratio of *phi* is precisely expressed in the global circumference distances between Giza, Angkor and Nazca (4.2). Because of this perfect ratio any three consecutive numbers of the Fibonacci series can be used to precisely describe their proportionate distances, the unit of measure itself defined by the specific Fibonacci triplet chosen. The Fibonacci triplet beginning with prime Fibonacci #137 accurately expresses the Sine Wave circumference distances as a percent of the whole circumference.

The Fibonacci triplet beginning with the next prime Fibonacci number, #359, accurately expresses the Sine Wave circumference distances in miles. This profound underlying relationship informs the application of the Mandelbrot set, which has been suspected by many as being a fundamental construct of the universe. The high degree of accuracy of these alignments forces the conclusion that ancient Sanskrit society's capacity for aerial surveillance far exceeds that achieved today.

The Earth's circumference distance from Giza to each resonant ancient site is coincident with two separate nine-digit sequences from the F series, presented in their entirety at this chapter's end, with GPS distances for 127 sites. These megalithic and earthwork sites accurately reflect the Fibonacci number set $131-139 \times 10^{-27}$ in percent of circumference distance. These exact Fibonacci site distance relationships are also accurately reflected in miles by the Fibonacci number set $353-361 \times 10^{-71}$. The two number sets are linked by a triad of consecutive prime Fibonacci numbers –131, 137 and 359. This triplet is at prime placement within the order of the Fibonacci series (131, 137 and 359 are prime), but their values are also prime: 1066340417491710595814572169, 19134702400093278081449423917, and 475420437734698220747368027166749382927701417016557193662268716376935476241.



4.3. The Sine Wave of ancient sites, tilted 30° off the equator –the Giza pyramids' east-west infrasound alignment

This intriguing relationship of Fibonacci sequence primes is also detailed at the end of this chapter, including a listing of the first 16 such numbers in the sequence. Since the ancient origin of the mile is unknown, these newly recognized precision Fibonacci alignments strongly suggest that the mile is a unit of measurement inherited from the pyramid-builders themselves. This ancient application of the nonlinear progression of phi distance relationships to calculate infrasound resonance locations is made possible by the self-similar nature of the sequence, dictating that all consecutive samplings of the sequence express identical ratios regardless of their magnitude. For this reason, any nine-digit sequence from the Fibonacci sequence would accurately reflect the megalithic site distances from Giza. *Apparently the mile is a unit of measurement specifically calibrated for convenient calculation of global resonance patterns through the application of number sets from the Fibonacci sequence!*

The mathematical constructs presently attributed to Fibonacci and Mandelbrot are indeed rediscoveries of the sacred Sanskrit four-dimensional geometry of the pyramid-builders that had been used in the construction of every pyramid and megalithic site worldwide. The overwhelming evidence for this conclusion is monumentally present all over the world in magnificent grandeur, both on land and buried on the ocean's shelves, awaiting discovery by remote sensing survey at specific Fibonacci nodal points.



4.4. Complex plane of the Mandelbrot set –a section of the Mandelbrot quaternion

The Sine Wave of ancient sites in alignment with Giza was discovered by Jim Alison,² whose thorough mathematical analysis has revealed a new kind of ancient *sine* language. Eighteen major temple sites are aligned precisely along a circumference forming a sine wave with amplitude of 30° (from the equator) and a frequency of one day. This is quite literally *the frequency of the Earth*. The circumference of the Earth as measured from 30° North latitude to 30° South latitude is approximately 24,892 miles. As the Earth rotates, this circumference line traces a sine wave. Each previous axial and magnetic orientation of the planet³ can also be described in this way. The variety of resonant sites along the Sine wave alignment includes cave painting sites, rock-cut temples, ziggurats, ancient cities, standing stone monuments, sacred processional markings, subterranean temples and megalithic sites. While the aligned temples belong to diverse cultures, the common use of piezoelectric stone construction materials or marked naturally echoing sites for attunement to the deep tri-thalamic heartbeat resonance by which states of synesthesia are induced in the spiritual practitioner.

The Sine Wave alignment is a cross-section through the sphere of the Earth along which sacred ancient sites conform to the Fibonacci-ordered complex plane of the Mandelbrot set [$z_{n+1} = z_n^2 + c$] (4.4). This circular network of phi-proportioned sites can also be visualized as a cross-section through the Magnetic Resonance fractal (4.5). Global positioning data for each site is provided in the final section of this chapter. The abbreviated name of the site is given with the percent of the circumference distance from Giza (An = Angkor, at 19.1% from Giza). Vibratory energy from Giza is simultaneously transduced at each resonant site after the 1.45 Hz oscillations of the Great Pyramid encircle the globe, taking 4 hours to return to their source. Piezoelectric stone structures worldwide transduce a broad-spectrum of vibratory energy into a magnetic field by virtue of the angular geometries specifically designed to focus infrasound.

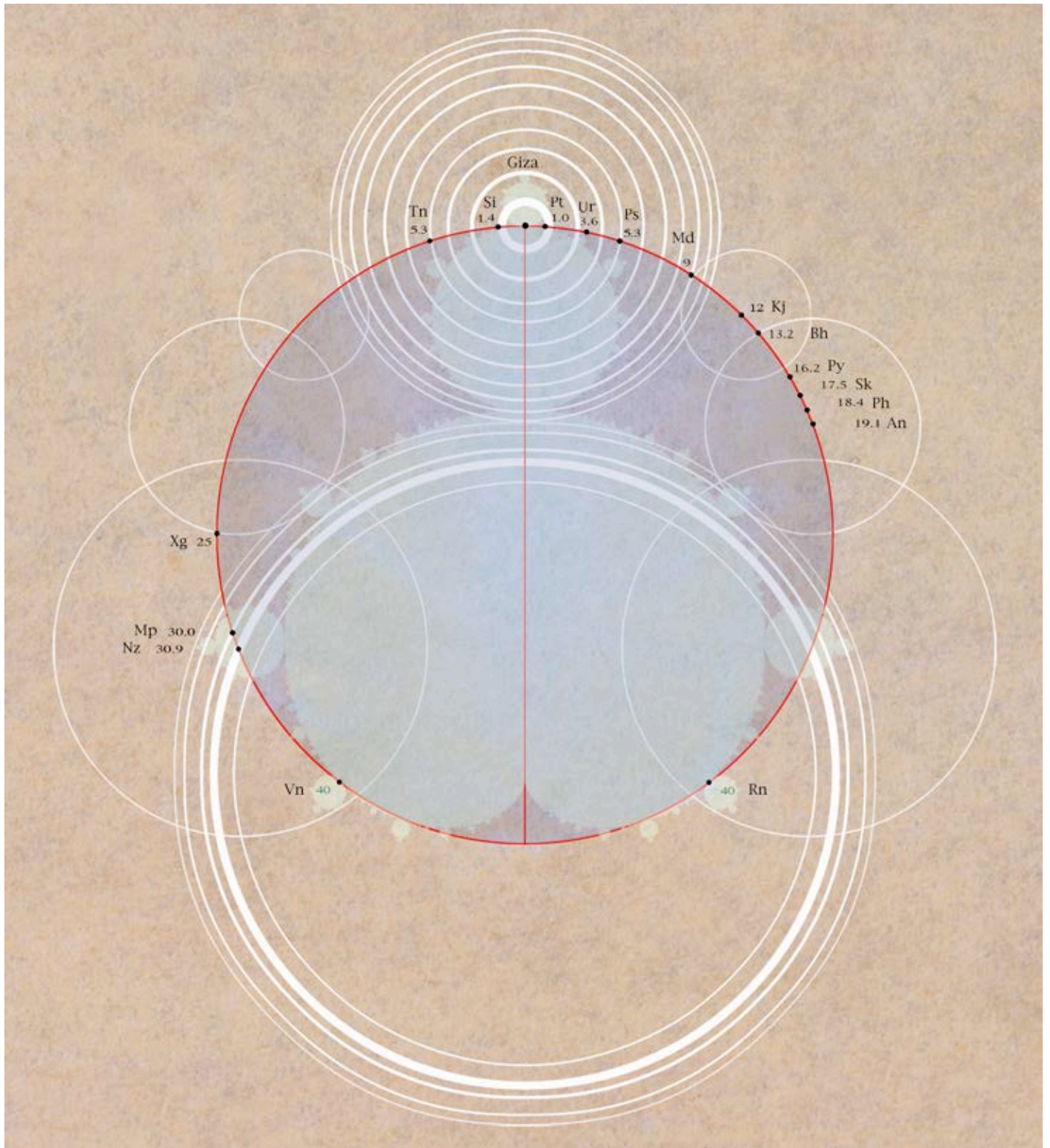

4.5. Sine Wave alignments (red) with resonant distances from Giza given as a % of Earth's circumference

The Sine Wave of ancient sites is presented as a circle in red, overlaid with a cross-section of the Magnetic Resonance structure in white. The sacred sites conforming to this planar alignment display Fibonacci-ordered distances from Giza that are provided in percent of the circle's circumference of 24,892 miles (listed clockwise from Giza): Petra 1.0%, Ur 3.6%, Persepolis 5.3%, Moenjodaro 9.0%, Khajuraho 12.0%, Bodh Gaya 13.2%, Pyay 16.2%, Sukhothai 17.5%, Phimai 18.4%, Angkor 19.1%, Rapa Nui 40.3%, Vanuatu 39.3%, Nazca 30.9%, Machu Picchu 30.0%, Xingtu 25%, Tassili N'ajjer 5.3% and Siwa 1.4%.

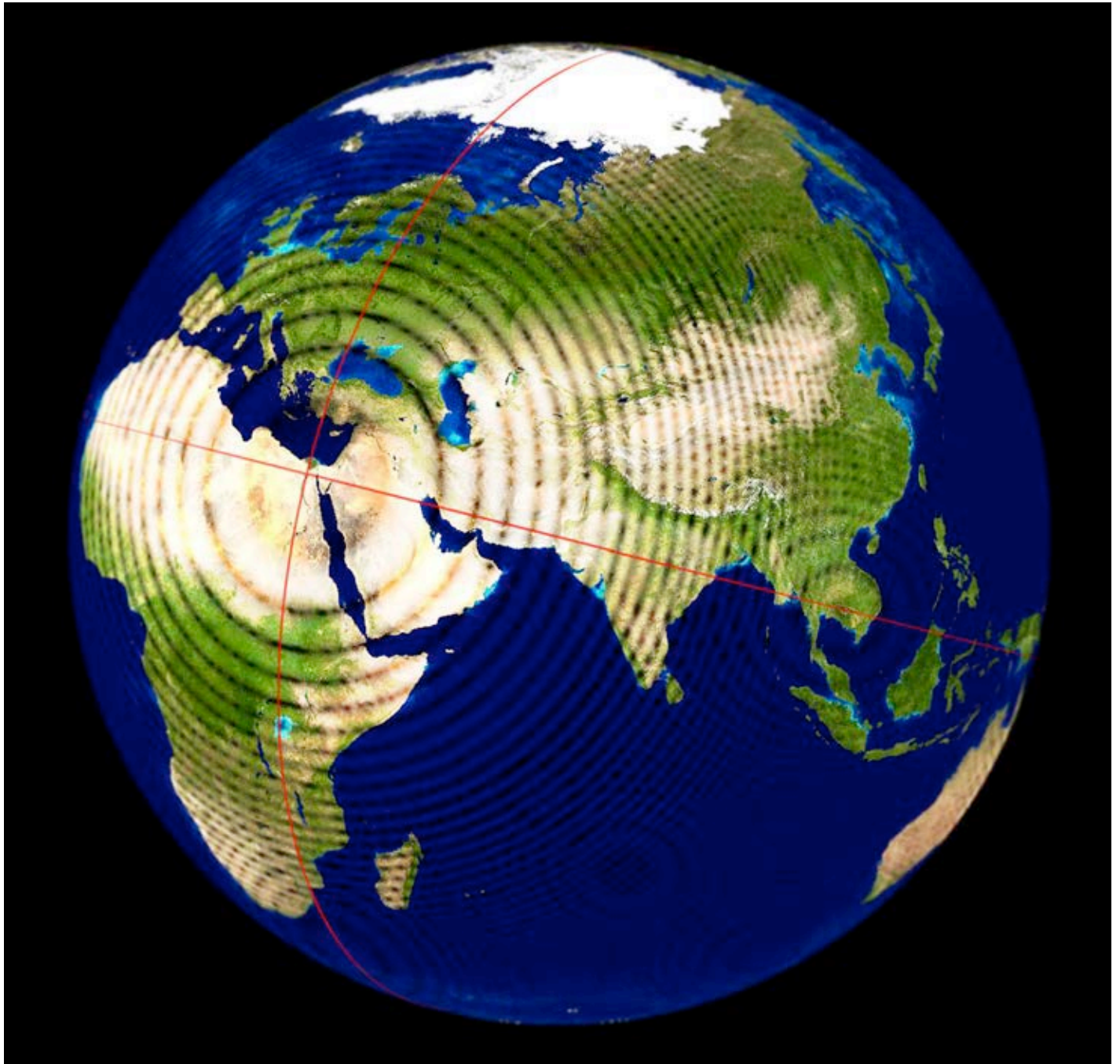

4.6. Quadrupolar standing wave pattern of Magnetic Resonance emanating from the Orion pyramids of Giza, Egypt

Ultra low frequency standing waves aligned to the four faces of the Orion pyramids at Giza form concentric rings at precise Fibonacci distances, defined by the function $[Z_{n+1} = Z_n^2 \text{ modulo } n]$ presented geographically in the Magnetic Resonance map of Earth's eastern hemisphere (4.6). The series of great concentric circles expanding from the center-point at Giza form a progression proceeding in percent of Earth's circumference: 3.6, 4.5, 5.3, 6.6, 7.3, 8.2, 9.0, 9.5 and 10.0%. The eastern hemisphere's most prominent ancient stone architectural sites are demonstrated here in complete correspondence with the complex Magnetic Resonance alignments (4.7). Global positions and Fibonacci distances from Giza are provided at the conclusion of this chapter for each numbered sacred site presented in the following sequence of Magnetic Resonance spherical maps. The world's dominant contemporary religions are founded on sacred piezoelectric architecture sites located within the greater structure of infrasound resonance: the Vatican in Italy, Jerusalem's Temple Mount in Israel, and Mecca in Saudi Arabia. *The psychoacoustic technologies employed by religious architecture are the same in every system of belief.*

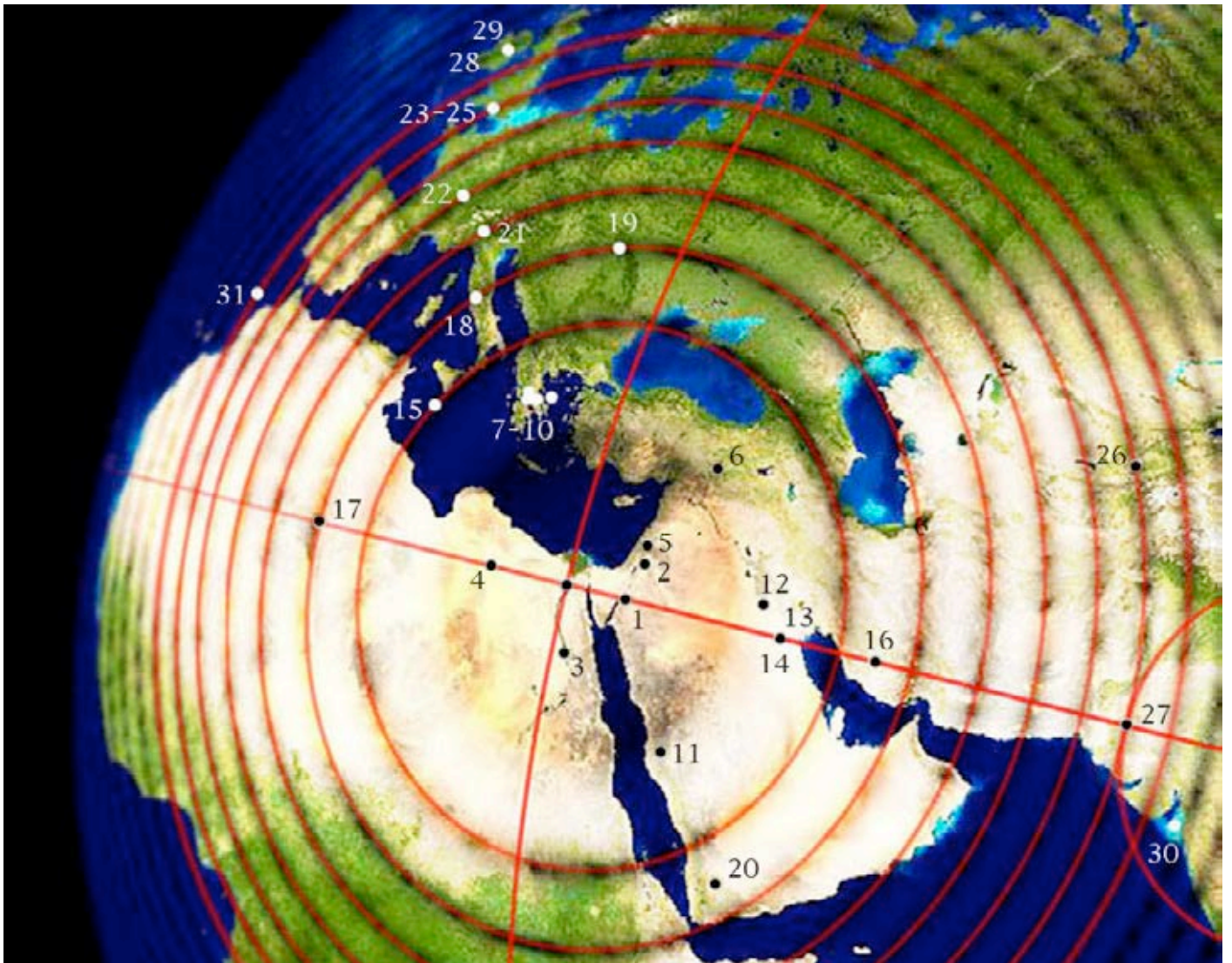

4.7. Standing waves of Magnetic Resonance extending to 10% of the Earth's circumference distance from Giza

A few recently discovered sites are presented here, including the submerged site in the Gulf of Khambat #30 off of Gudjerat. Among many piezoelectric temples in Malta #15 is a newly discovered submerged temple. The vaults of elongated skulls showing advanced cranial augmentation below Malta's temples⁴ may have been developed through full-spectrum ULF wave entrainment from Giza transduced by the properties of the numerous limestone temple structures including the Hypogeum, Mnajdra, Ggantija, Hagar Qim, Hal Ginwi, Tarxien, Tal Qadi, Tah'Hagrat, Skorba and Bugibba. Two ancient pyramid sites recently discovered are also in resonant alignment: the low-angle Orion pyramids of Montevecchia, Italy⁵ #21 and the pyramids of Samarqand, Uzbekistan #26 yet to be fully documented.⁶ The dune-covered regions of the Sahara Desert of Northern Africa may conceal temple locations to be revealed by remote sensing using ground penetrating radar and sonar; tools only recently employed in archaeology that have revolutionized site surveillance capabilities and exposed dozens of new monumental temple sites.

Ancient Sites	Distance (% , miles)	Fibonacci Series (prime)
Giza – Petra circle	1.06 264	#131 – 106... #353 – 2649...
Giza – Ba'albek circle	1.71 428	#132 – 171... #354 – 4286...
Giza – Nemrud circle	2.79 694	#133 – 279... #355 – 6936...
Giza – Malta circle	4.50 1,122	#134 – 451... #356 – 1122...
Giza – Glozel circle	7.30 1,815	#135 – 730... #357 – 1815...



4.8. Mumbahuru's 15' thick granite south wall with double waveforms and the Zimbabwe bird with waves and circles

In central Zimbabwe, due south of the Giza plateau, massive granite stonemasonry is found at the hilltop Acropolis which overlooks the ruins of Mumbahuru, meaning 'House of the Great Woman' (4.8). Maternity symbolism informs an interpretation of the design of the site as a woman's womb carrying a developing fetus, with the kundalini snake moving upward along the spine and toward the pelvis of the fetus. This monument may be a psychoacoustic facility for resonant fetal gestation as the buildings in the center of the enclosure are constructed of a ferrous clay mixed with a granite aggregate of quartz, both materials acting effectively as piezoelectric transducers of the ULF acoustic energy generated by the Giza pyramids. The massive granite walls reach a thickness of 17' and extend to a maximum height of 32' at the south end of the complex, and are constructed without mortar. Psychoacoustic symbols of zigzag waveforms and circles accompany the Zimbabwe bird that flies in waves of wing beats (4.8, right).

Dominating the southernmost area of the enclosure is a 35' tall conical tower that takes the form of a symbolic kundalini lingam of Sanskrit tradition. The large conical tower lies symbolically at the anus of the fetus, another reference to the use of a lingam to raise the kundalini or *umbilini serpent*. The widespread findings of ancient Sanskrit cultural remains on several continents will be discussed in detail in the following chapter, an unmistakable global heritage that has yet to be fully recognized by archaeologists. Indeed the most irrefutable evidence comes in the form of an Archaic Sanskrit script that has been documented on several continents among collections of truly remarkable artifacts. The maternal imagery of the ancient Sanskrit temple of Mumbahuru is also clearly presented in other stoneworks from this newly identified culture, revealing a profound knowledge of fetal development.

Ancient Zulu regional wisdom has been passed down, perhaps directly from the very builders of Mumbahuru, through the sacred teachings of sangomas. Vusamasulu Credo Mutwa, the Zulu High Sanusi, relates the spiritual teachings of his grandfather. Sacred knowledge utilized and preserved by Zulu sangomas through cultural traditions spanning millennia provide further African evidence of the worldwide antediluvian heritage of Sanskrit kundalini consciousness:

My grandfather taught the Zulu version of what is called in English 'meditation'. How to breathe softly and gently like a whisper until you feel something like a hot coiled snake ascending your spine and bursting through the top of your head - a fearsome thing that is known as umbilini. This umbilini, my grandfather told me, is the source, the primal source of the sangoma's powers. A sangoma must be able to summon this umbilini at will through the beating of the drum and through meditation.⁷

Clearly the Sanskrit energetic teachings have ancient roots in a once widespread culture of which only fragmentary teachings still exist. The enclosure has been designed as a woman's womb (4.9, left), with the entrances representing the navel (1), urinary tract (2), vagina (3) and anus (4). A long narrow passageway along the eastern wall can be seen as the umbilini serpent rising through the spinal cord, its eye represented in a small conical construction next to the large conical tower as the passage opens up. Excavated from a shallow depth were three granite lingams (4.9, right), well known Sanskrit spiritual tools used anally during meditative practice, further confirming the temple's cultural origin. The interior walls of the enclosure can be seen to represent a fetus whose head is directly aligned to the modern longitude of 31°, the ancient Prime Meridian (0° longitude) marked by the Orion pyramid complex at Giza.

The egg-like form of the giant resonant quartz enclosure is another reflection of the womb symbol for psychoacoustic fetal development. The Zulu name 'House of the Great Woman' confirms the primacy of the female capacity for motherhood and the holistic maternity processes of the antediluvian Sanskrit world-culture. Fetal development and water birthing methods once undertaken in the chambers of the Giza pyramids were also practices at Mumbahuru and other sacred sites around the world geopositioned within the mandala alignment. The heartbeat resonance of 1.45 Hz is the base frequency of the Great Pyramid due north of the Mumbahuru site transducing a deep theta wave oscillation felt at focal points.

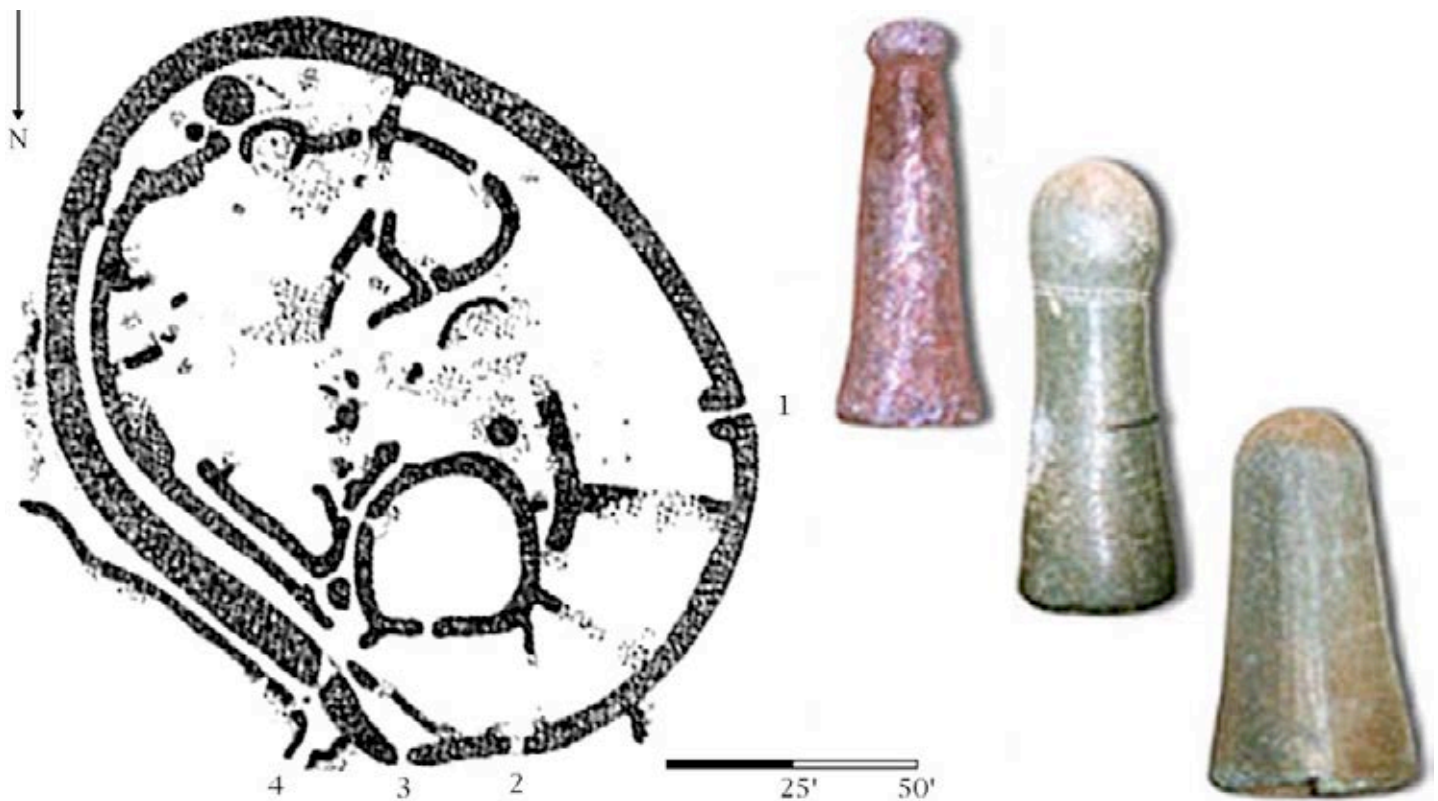

4.9. Mumbahuru with entrances corresponding to the mother's womb and three granite lingams excavated inside

Ancient stone temple ruins exist in abundance in Southeast Asia, numbering in the hundreds and belonging to various traditions, periods and styles. Only a core group are included in the alignments along the Sine Wave of ancient sites and the pair of smaller circular alignments (4.10): the first centered on Khajuraho #32 at 12.0% of the Earth's circumference from Giza, and the second circle centered on Angkor #41 at a distance of 19.1%. Included in the group of temples plotted are three submerged marine archaeological sites with geometric structures and megalithic ruins: the Gulf of Khambat #30, Mahabalipuram #34 and the majestic Yonaguni sandstone monument #48. While the first of these two marine archaeological sites are associated with existing cultural remains above sea level, the third is perhaps the most exceptional site in the entire region.

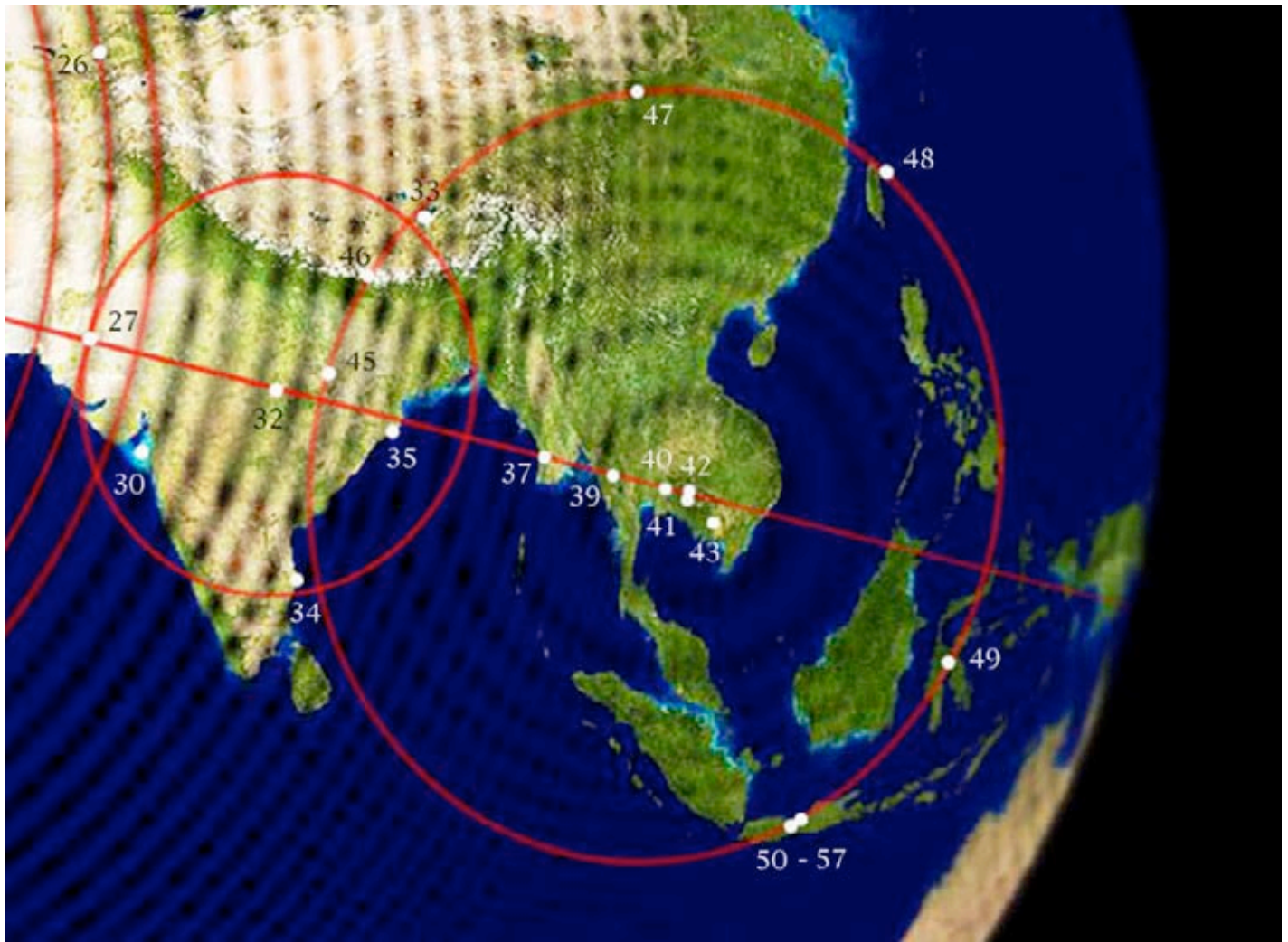

4.10. Magnetic Resonance nodal alignments seen at 11.8% (#32) and 19.1%, centered on the Angkor complex (#41)

Yonaguni #48 is a gigantic geometrically carved platform over 450' in length with megalithic arches and a cave opening that are hewn from a single massive outcropping of the Yaeyama mudstone formation off Iseki Pt. These marine sites are all less than 100' of depth and must have been constructed over 9,000 years ago, when more of the Earth's water was trapped in the polar glacial icecaps lowering sea levels. The design layout of the Orion's belt constellation is observed at both the Xi'an pyramids #47 and the Borobudur limestone Buddhist temples #51-57. Several of Java's Buddhist sites have clearly been designed using the same underlying geometry evident in the stepped pyramids of Mesoamerica, with a steep central ascending stairway. Temple sites mapped in the eastern hemisphere represent the foundation of many contemporary religions including Islam, Hinduism and both Theravada and Mahayana traditions of Buddhism. Hindu sacred temples are spread throughout India and described here only by a few prime sites including Mahabalipuram #34, where temples on the present shoreline sit adjacent to those now submerged off the coast and recently discovered by G. Hancock.⁸

The Gautama Buddha's enlightenment occurred at Bodh Gaya, a site in resonant alignment with the infrasonic waves of Giza's Orion complex, situated at Fibonacci distances from both Giza and Angkor. The Tibetan Buddhist capitol of Lhasa (29.68°N, 91.17°E) #33 is aligned due east of Giza (29.97°N, 31.11°E), at *exactly one sixth* of the latitudinal circumference at the 30th parallel. The Mandelbrot Set is also presented as a design principle underlying the layout of Angkor temples and many ancient images of the Buddha (4.12). The global positions of the temple sites reflects a nonlinear geometry in relation to Giza, which is echoed in the architectural designs in myriad ways, only discussed briefly here. This mathematical repetition, the essence of fractal self-symmetry, extends both inward and outward in the



4.11. Bronze Vishwa vajra of Tibetan Buddhism (left) is a complex representation of the Octagonal QIF (right)

cosmological mandala maps of temple-building civilizations –the idea of the outer perceptual world being reflective of the inner world. The reflective relationship between the heavens and the Earth is mathematically embodied by fractal self-similarity, often seen as a central design element of stone temples, earthworks and sacred symbols, like the Vishwa vajra of Tibetan Buddhism that encodes the four-dimensional mandala form defined mathematically by the Octagonal Quantum Iterated Function (4.11). The Mandelbrot set can be magnified endlessly through successive iterations of the seed equation to reveal layer upon layer of *self-similarity* –reflecting Fibonacci-order on all scales. This *holographic* concept is central to understanding the structural qualities of four-dimensional fractal sets. The four-dimensional geometry underlying the relative locations of ancient temples is also reflected in the very layout designs of those same temples themselves, displaying their orientation within the greater pattern. Phi-proportions are an essential element of sacred architecture the world over. This sacred cosmic self-similarity is further confirmation that the architects of the structures were acutely aware of their precise position within the sacred resonance of Earth by geometric relation to the Great Pyramid at Giza.

4.12. Mset structure of Angkor Wat (left), lotus Buddha image (center) and the Octagon Mound, Ohio, US (right)



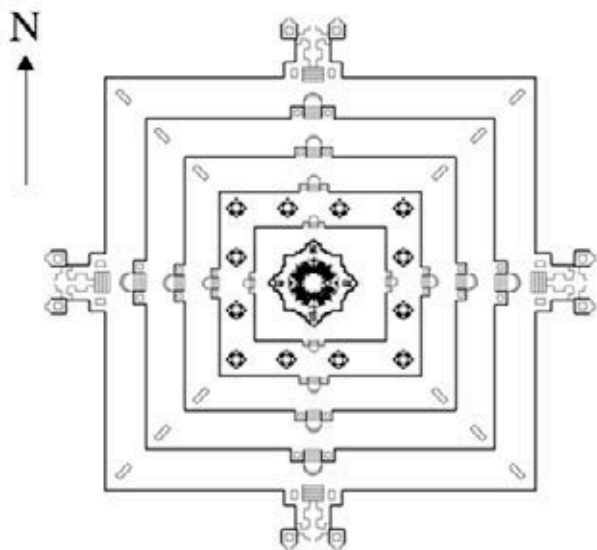

The design of Angkor Wat in present-day Cambodia displays Mandelbrot geometry in a group of phi rectangles ascending in scale symmetrically from its center (4.13). The increments of the ascending sizes also reflect the phi ratio in a perfect symbol of self-similarity, emanating from a sacred focal point. The octagonal layout of the nearby Angkor Bakong (4.14, top) is conforms closely to the Magnetic Resonance fractal, while east-west dimension is asymmetrically lengthened. In the layout of the Octagon earthworks of Newark, US the Mset design is also quite striking and simply stated (4.12); an octagon representing the Giza site attached to a smaller circle representing the magnetic North pole, and a smaller circle outside the octagon showing the west-northwest direction of the mound site in relation to Giza. The positioning of the earthwork's entrances symbolizes a main flow of energy through the lengthwise symmetry in a monumental octagonal distribution pattern.

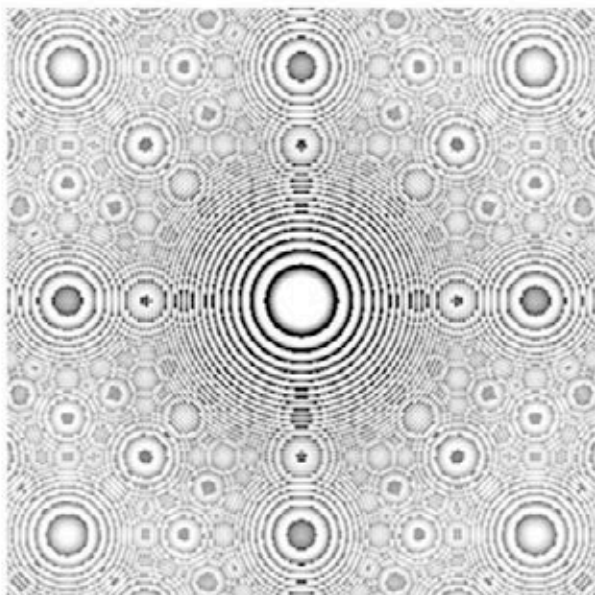

Buddhas are often portrayed in the lotus position sitting atop a lotus of a thousand petals, representing the crown chakra of the energetic body, through which flows the kundalini energetic serpent (4.12). The Mandelbrot Set's phi-ordered circles are repeated in the proportions of the figure, its hairstyle and background, as clear references to fractal self-similarity. Buddhas are seated in temples at resonant Fibonacci distances from Giza, as the Mandelbrot set image is repeated in scale from the seated human figure, in the proportions of the room and of the building and the enclosing wall, and the proportions of the distances of all other resonant sites described. Theravada Buddhist traditions from India visually present the dharma wheel, symbolic of the Buddha's teachings, as a circle with eight spokes radiating from the center. Also reflecting this sacred geometric code for resonance is the octagonal Tibet sacred sand Mandala formed by a square within a circle, sharing the symbolic form of the Vishva vajra (4.11). Various Buddhist traditions in Japan employ similar symbolism, especially noted in a sacred symbol for 'well being' (4.13, bottom) that exactly matches the Magnetic Resonance fractal (4.12, center). The serial repetition of the Mandelbrot set $[z_{n+1} = z_n^2 + C]$ and Magnetic Resonance fractal $[z_{n+1} = z_n^2]$ in sacred art and architecture worldwide reveals an ancient shared understanding of the psychoacoustic nodal points where infrasound is resonantly focused by the Orion pyramids of Giza. Perhaps the most compelling evidence of the vastly ancient interconnectedness of human knowledge can be found on the continent of Australia, where cultural traditions have been preserved since *the dreamtime*.



4.13. Bakong plan (top), and 'wellness' (bottom)



4.14. Uluru monolithic sacred site (top) displays aboriginal paintings including concentric circle alignments (bottom)

The aboriginal cultures of Australia are known as the oldest lineages of continual oral traditions in the world, stretching back into time virtually unchanged for more than 60,000 years, as firmly established by multi-layered rock art sites dated throughout the continent. Aboriginal ceremonies include a host of low-frequency psychoacoustic instruments like *the didgeridoo* and *the drum*, while long distance ultra low frequency messages were sent using *the bullroarer*—a grooved wooden paddle on a cord that is swung to produce a low humming that can be heard over great distances. Aboriginal Tjukurpa or dreamtime energy paintings often depict animal spirits, ancestral beings and sacred dreamtime land-scapes of concentric circle networks, as on the rock walls of the Uluru sacred site (4.14). The giant red Uluru monolith is 7,617 miles from the Giza pyramids—30.6% of Earth’s circumference (F#138).

US Naval Research Laboratory
GOES-10 Infrared
Dec 7 - 8, 2001

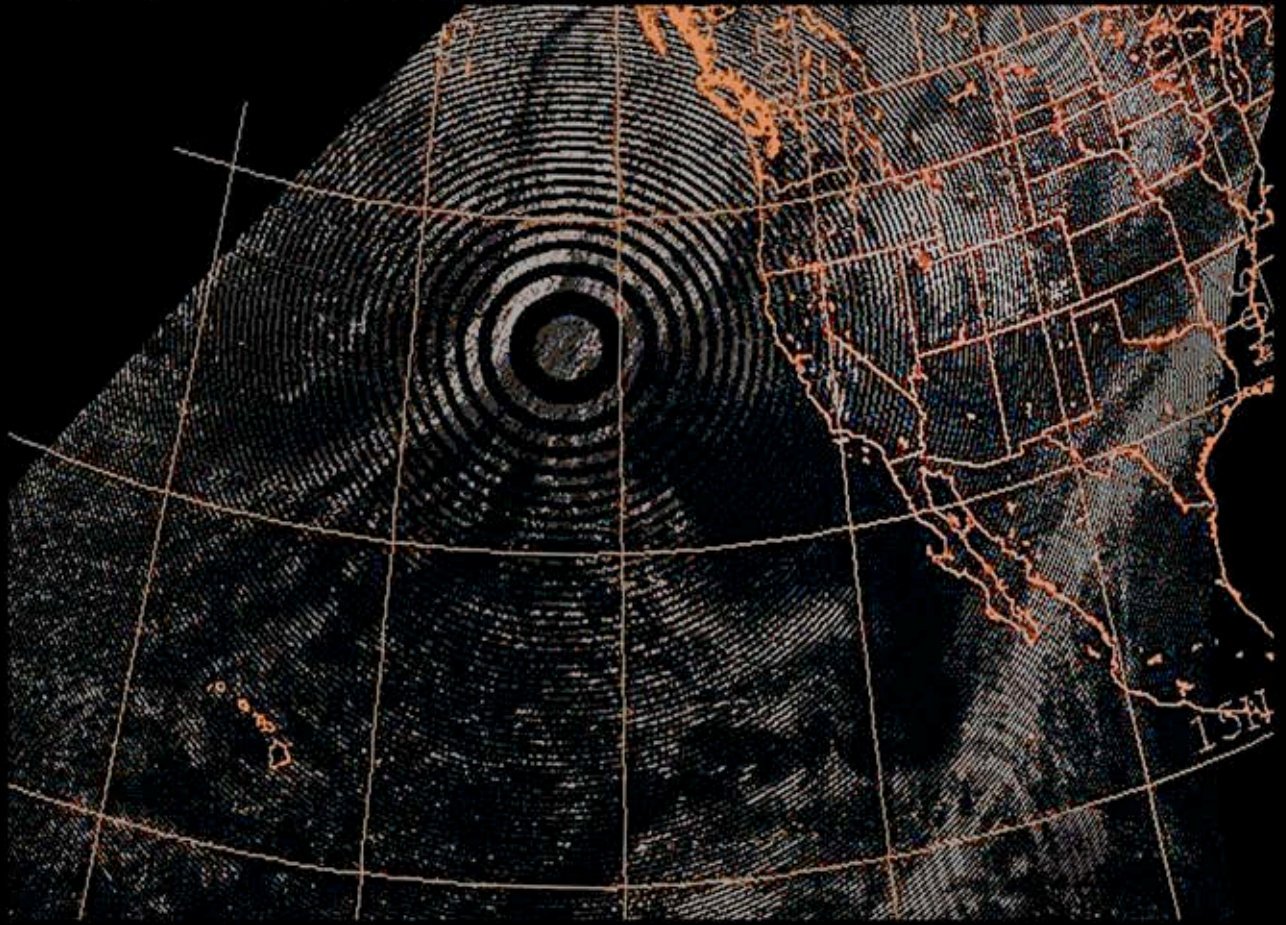
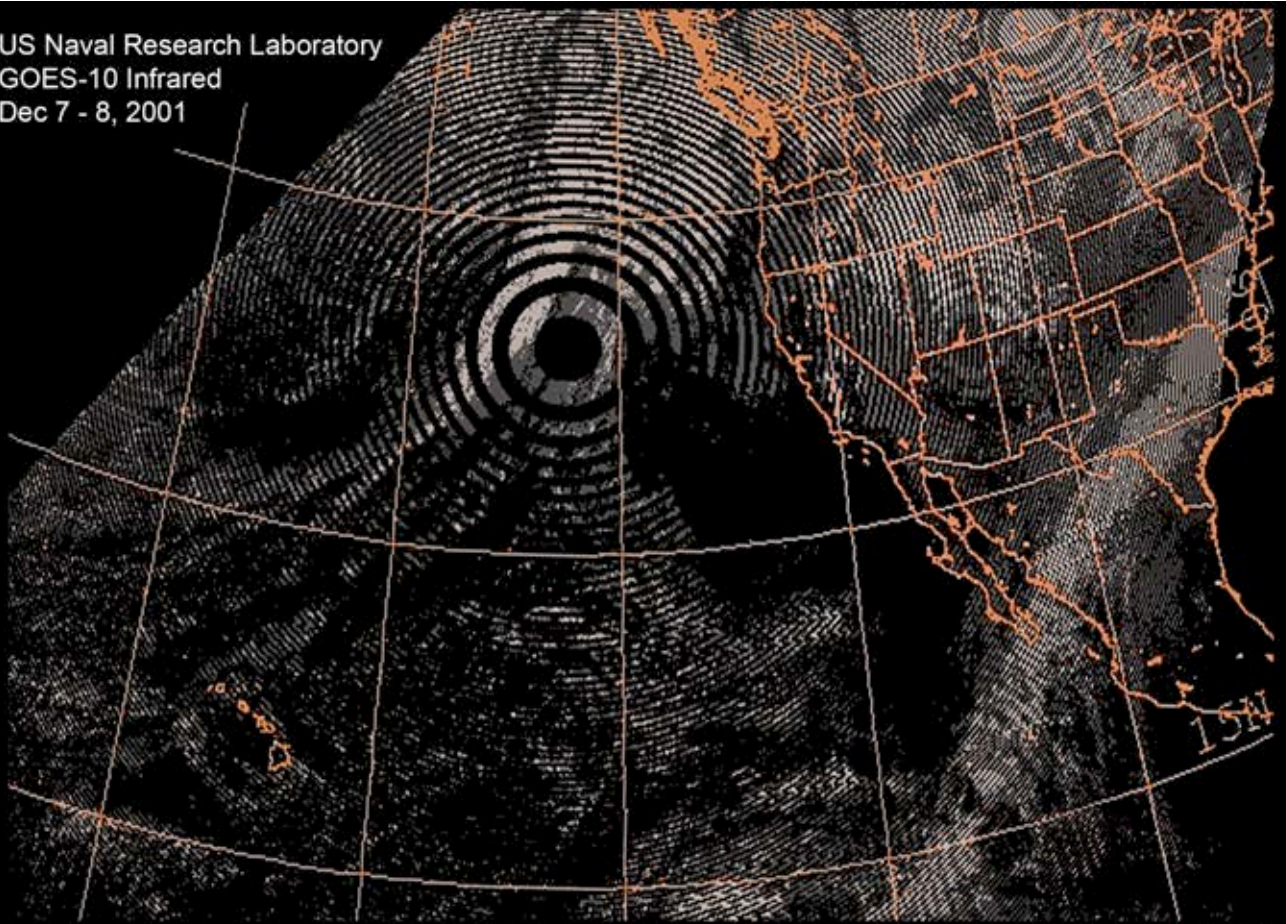

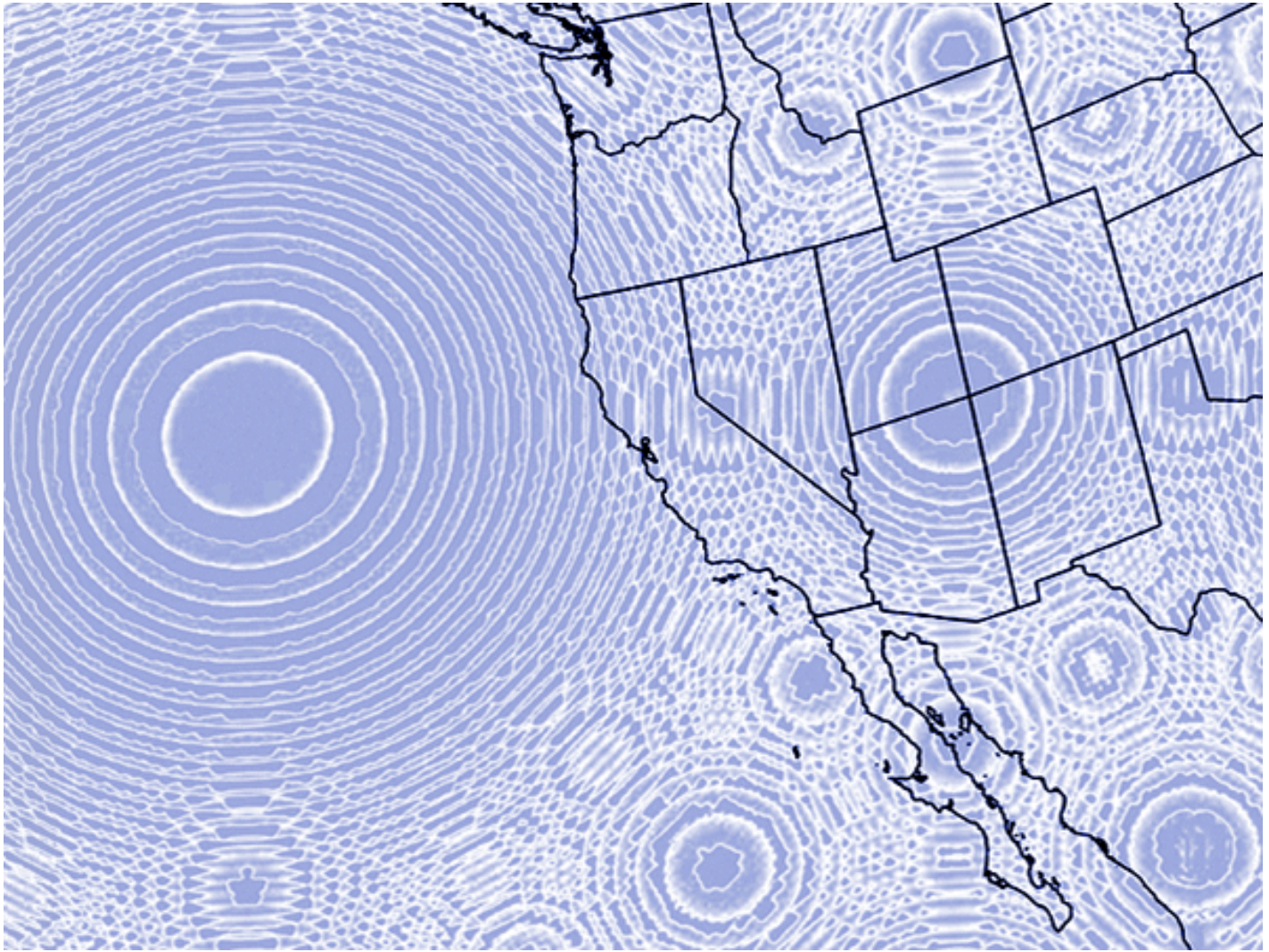

4.15. (Opposite) GOES-10 satellite data for the infrared spectrum from the night of December 7-8, 2001
 4.16. Image enhancement of the GOES-10 data using the four-dimensional iterated function [$z_{n+1} = z_n^2$]

Direct measurements of the Earth's standing wave field being stimulated by the last solar magnetic reversal of December 2001 were made from orbit. GOES-10 Satellite survey of the Pacific region recorded anomalous atmospheric conditions across the full range of Earth resonance frequencies on December 7-8, 2001 (4.15). Both the infrared and visible spectrum measurements revealed an octagonal tiling of concentric circles in dipolar oscillation at 1.45 Hz –the tri-thalamic heartbeat. The unusual data was compiled and made available online at the Kauai Naval Research Laboratory website archive. The infrasound pulsation was recorded for many hours through the night, over the entire area surveyed by the satellite. As standing wave structures arise from the multi-frequency driving of the gas-filled resonant atmospheric cavity, this resonance field necessarily encompassed the whole globe for the full duration of the event. Another crucial fact suggesting a fully global effect is the field's alignment with 149°W longitude, exactly 180° from the Giza Pyramids at 31°E in Egypt, the ancient magnetic prime meridian.

Trolling the archives, cyberspace researcher Kent Steadman discovered the anomalous satellite data and dedicated a webpage to report the findings.⁹ After Kent's posting the Kauai NRL web archive was immediately cleansed of the anomalous data. This pair of leaked infrared satellite images captures two phases of a dipolar oscillation of standing wave resonance, continually reversing for several hours at a frequency of 1.45 Hz. High-resolution enhancements of the infrared standing wave patterns recorded by GOES-10 were rendered using the iterated function [$z_{n+1} = z_n^2 \text{ modulo } n$] (after P. Bourke¹⁰), to clearly reveal the octagonal Fibonacci lattice underlying the matrix of concentric circular alignments (4.16).

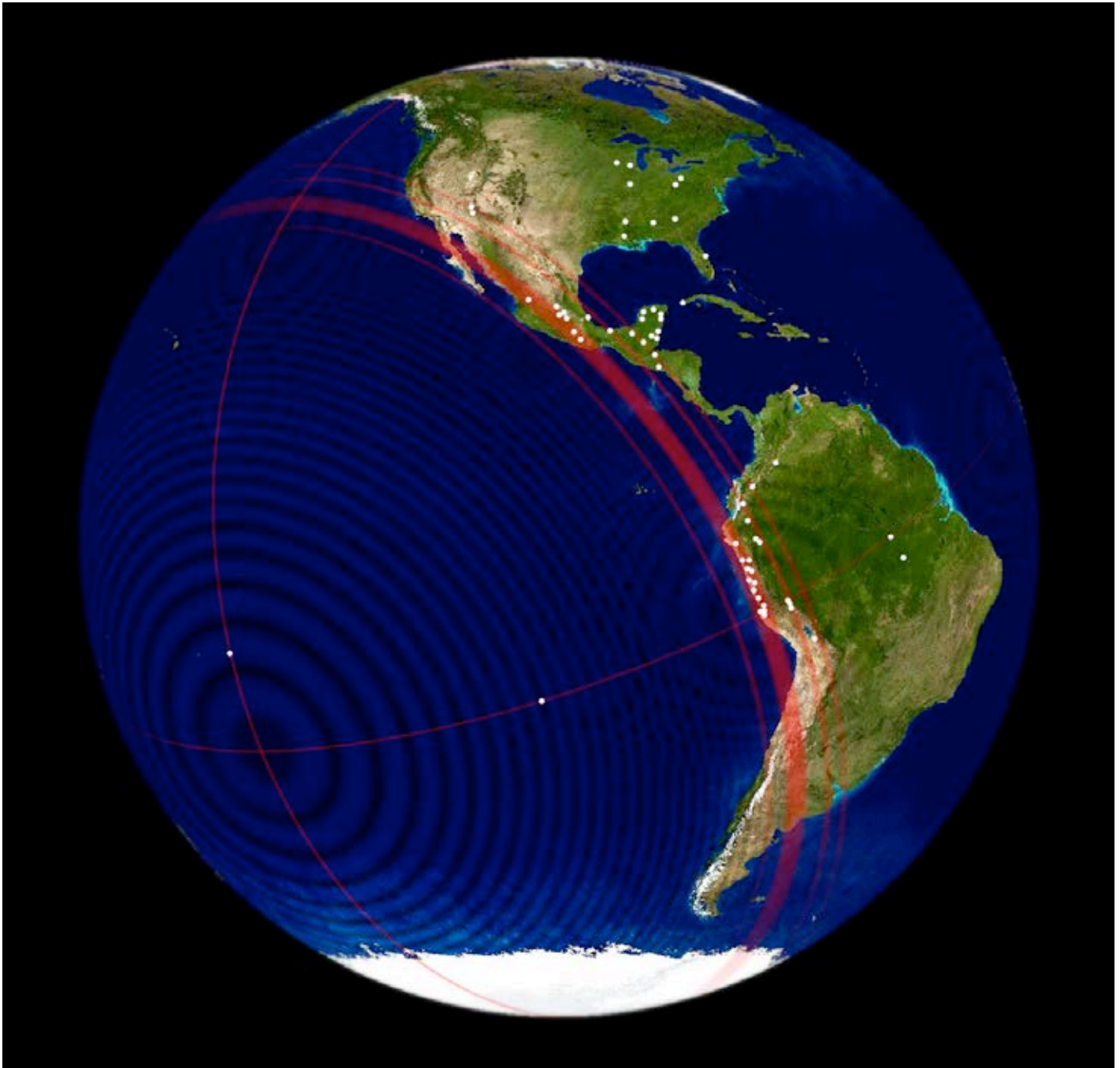

4.17. Magnetic Resonance map of infrasound standing waves in the western hemisphere with sacred sites in white

A spherical rendering presents the infrasound standing wave resonance pattern in the western hemisphere, where the resulting tectonic shifting generates earthquakes along “the Ring of Fire” (4.17). The relative geositions of ancient sites reveal that the sacred mandala symbol encodes the unified structure of the cosmos by which the pyramids focus the ambient energy of planetary resonance. While the infrasound oscillations are most distinctly seen by infrared observations, the resonance also becomes visible to Doppler radar due to the suspension of water vapor in the multi-layered standing waves. A composite image of stationary vapor cover over the United States from January 23, 2003 (4.18) provides a clear view of the fixed network of infrasound focal points. The correlation between the IR measurements and vapor reflectivity demands a thorough comparison with ancient Native American sacred sites beyond the few earthworks and mounds mentioned here. A detail image of the Magnetic Resonance mapping of Mesoamerica (4.19, left) shows synchronicity with the sacred maps of the Mayan Elders presently involved in the activation of their pyramid sites beginning at Calakmul Pyramid.¹¹

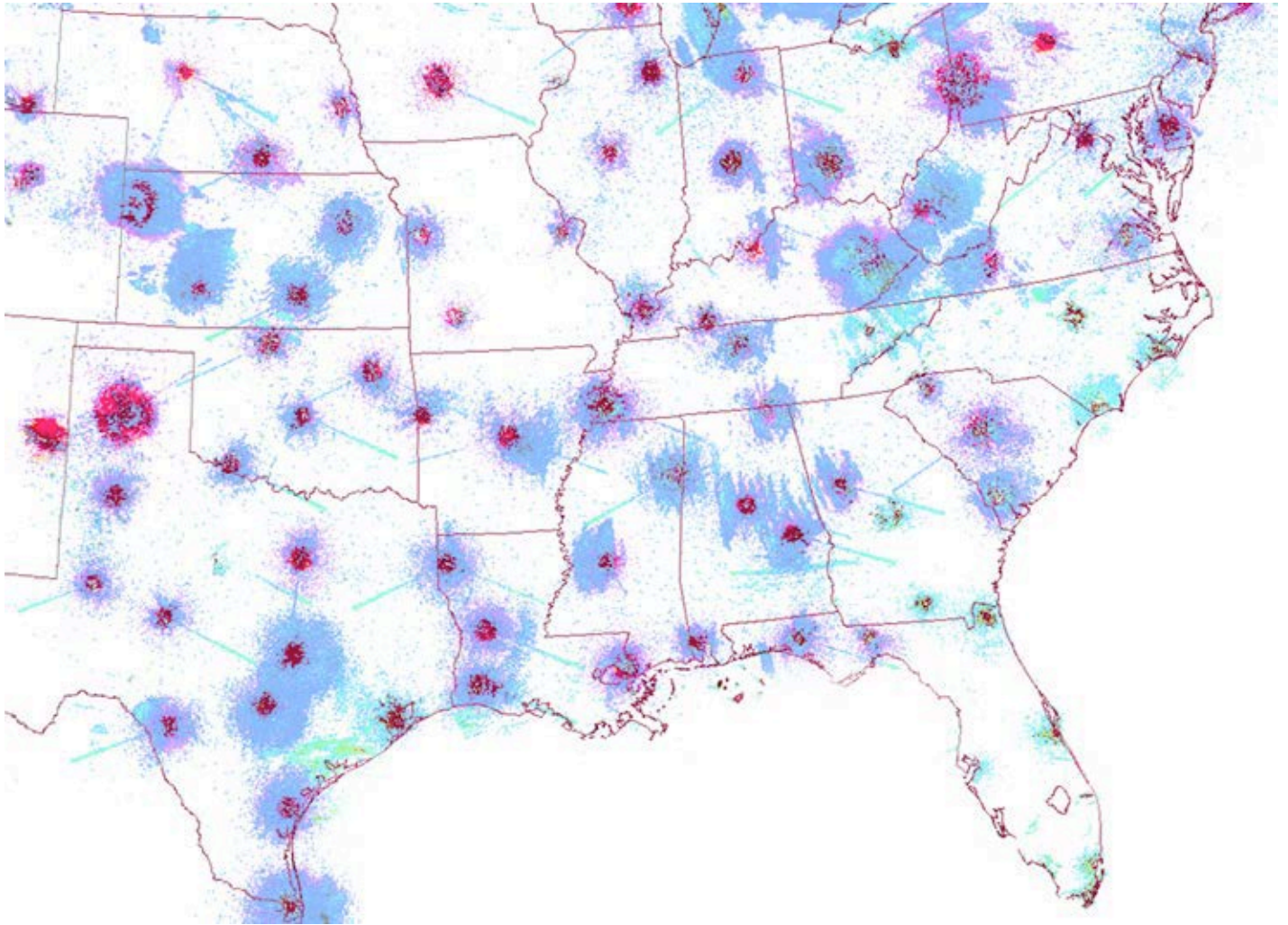

4.18. Water vapor suspended by standing waves recorded by Doppler radar over North America on January 23, 2003
 4.19. Resonance maps of ancient Mayan lands and Calakmul Pyramid (left) match maps made by Maya Elders (right)

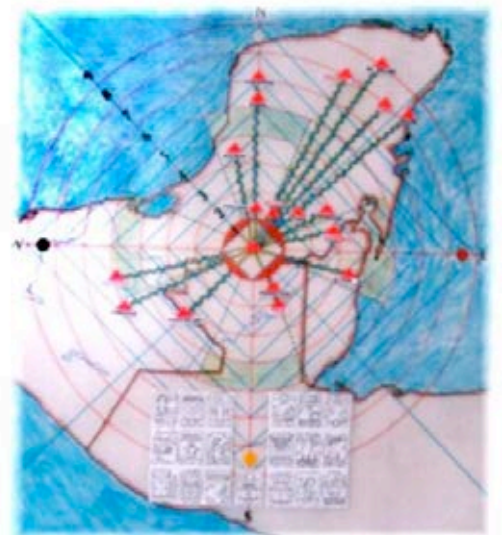
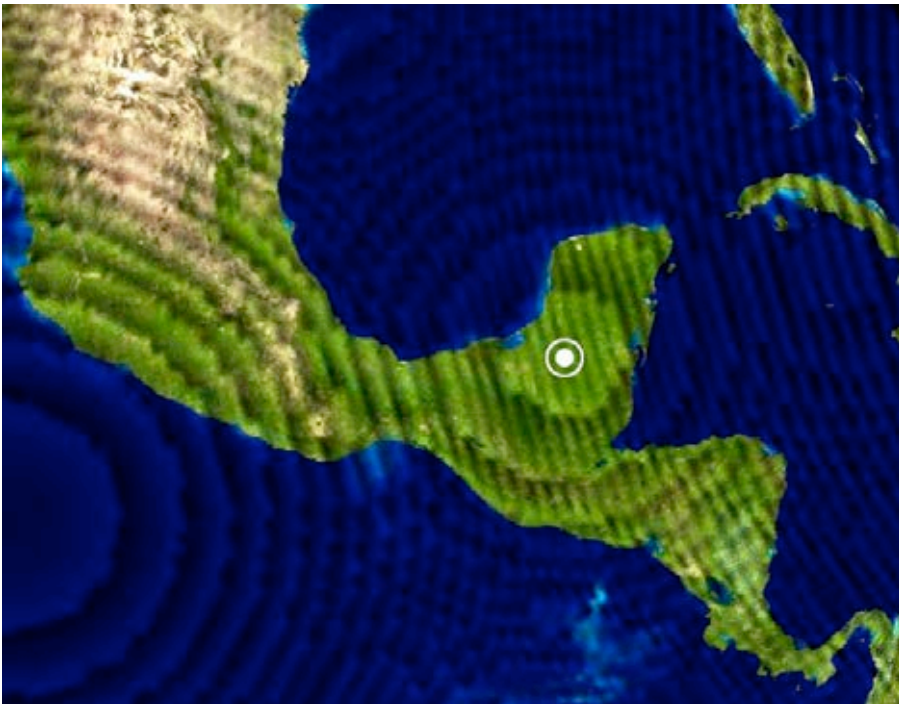

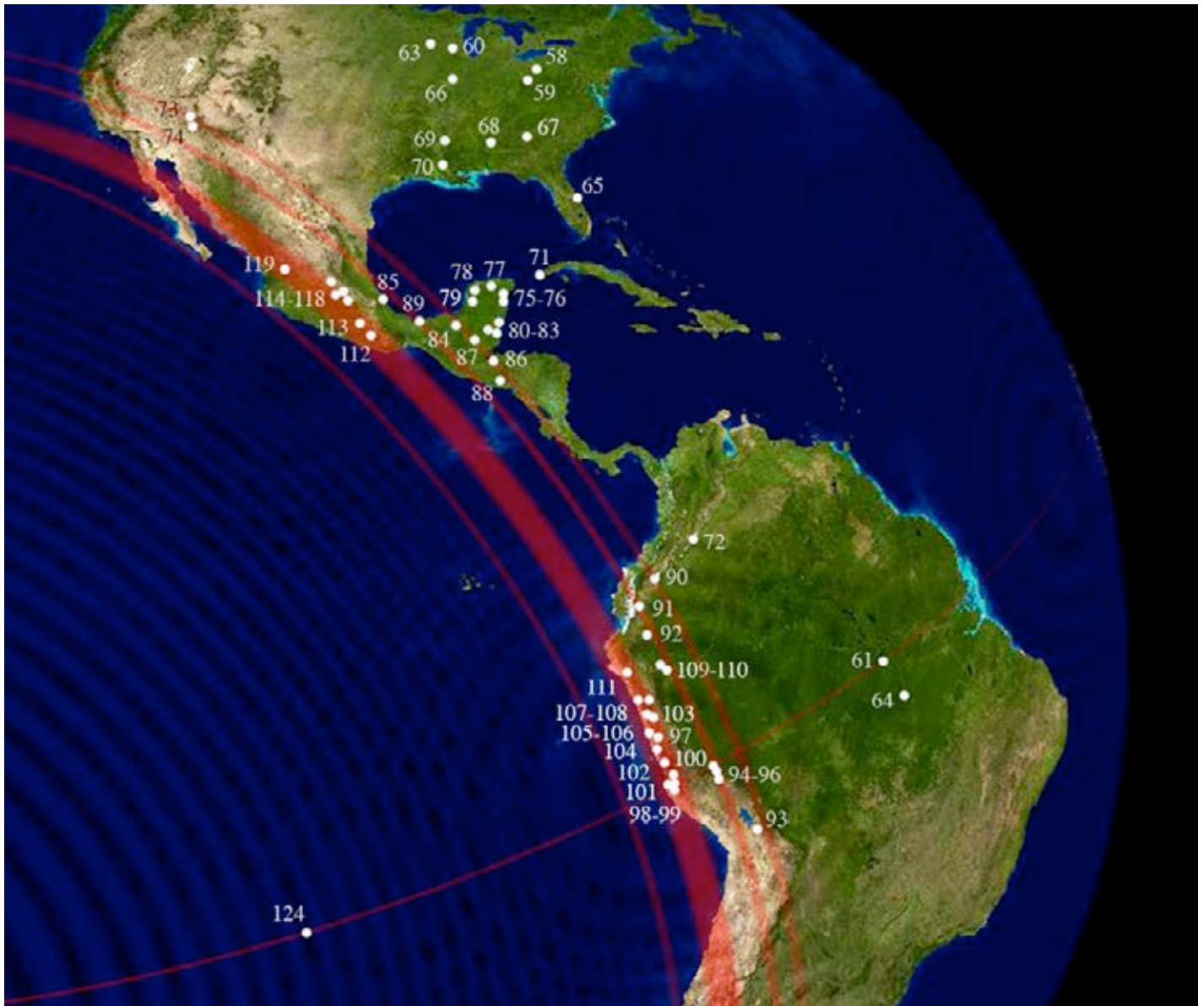

4.20. Magnetic Resonance field in the Americas, with the thickest line representing the 30.9% great circle distance

Mesoamerica and South America are regions of the highest concentration of ancient limestone and granite masonry anywhere in the world, as well as some of the most archaeologically rich and unexplored areas, like the Amazon basin. The region of highest density of limestone temples is surely the Yucatan peninsula, whose tropical forests still completely cover hundreds more temples including complete cities of temples spanning for unexcavated miles like at Piedras Negras. The many ruins of the Maya people are so extensive and unexplored. Even well known sites hold uncharted tunnel systems below. Only the most well known ancient temple sites are numerated here in the mapping of Magnetic Resonance in the Americas (4.20), but the extent of temples falling into this resonant band of alignment along the 30.0% to 30.9% great circle distance from Giza must number well over a thousand major sites. The rainforests of the Amazon are slowly revealing their ancient civilizations; M. Heckenbecker¹² has documented the solar and lunar alignments of complex ancient settlements of indigenous peoples of the Xingu River #61 and its tributaries including the Cuelene River #64. This region is also well known for its advanced indigenous traditions of trance entrainment using psychoacoustic whistles in all forms and materials, including stone, bone, wood, shell and ceramic. The most complex psychoacoustic instruments developed were the tri-harmonic stone flutes of the Bolivian Andes discussed earlier, and the most widespread cultural practices of psychoacoustic entrainment observed of any region in the world.

One submerged limestone architectural complex is also plotted in resonant Fibonacci alignment: the sand-covered pyramids of the Guanahacabibes Gulf #71 at a depth of over 2,000' off the west coast of Cuba.¹³ The dark oxidized limestone blocks confirm that the stepped pyramid structures were built when the area was above sea level, having been catastrophically lowered by massive subduction events likely linked with the global catastrophe that abruptly ended the Pleistocene glacial period and began the global warming trend defining the Holocene. Remote sensing and mapping of the submerged Cuban pyramid complex will provide details of the cosmic alignments of its buildings in the years to come, yet its placement within the structure of Magnetic Resonance can be determined by its geoposition. The distance from the Guanahacabibes Pyramids' to Giza is 27.77% of Earth's mean circumference, approximating F#133 (27.9×10^{-26}). This distance is 6,912 miles, which closely approximates F#355 (6936×10^{-70}). These megalithic structures stand among only a few others like Japan's Yonaguni marine site that have been so completely preserved by their inundation as to have captured the very moment of devastation, to be archived along the continental shelf, silted upon for millennia. Sites of subterranean discoveries are also included in this analysis, namely at Sutatausa, Colombia and at La Maná and Cuenca in Ecuador, though of vast number of temple sites include uncharted subterranean chambers. Key findings at these three sites will be discussed in the following chapter. Another category of sacred sites built within the Magnetic Resonance alignment are the earthen mound formations of North America that also display resonant properties as clay is piezoelectric, like limestone and quartz. The locations of circular kivas and the adobe cliff dwellings of the American southwest are also presented.

The largest rock formation symbolically designed as a sacred site by ancient people is the limestone Nazca Desert floor #98. Lines were dug into the dark bedrock to expose white underlying limestone, forming paths likely used in processional group meditation. The various geoglyphs mark the prime locality where infrasound heart beat entrainment frequencies are focused and become amplified by the resonant calcite formations. Indeed, the very rock substrate of the area was apparently used as a psychoacoustic transducer of ULF signals from Giza, as symbolized by the sacred animals depicted including the spider, monkey, killer whale and various birds, even one with a zigzag neck. A similar processional pathway is the Hummingbird geoglyph (4.21), whose head points directly along the Sine Wave of ancient sites to Giza's Wall of the Crow; symbolic of the sound of rapid wing beating culturally associated with psychoacoustic beat frequencies. The four directions presented by the geometry of the hummingbird path mark the other sacred alignments in Magnetic Resonance: one wing points north north-west to Teotihuacan and the tail points directly away from Giza to its antipode and the intervening Easter Island, site of the Moai megaliths, also known as Rapa Nui.

The latest findings in the Palpa valley area about 30 miles to the northwest of Nazca have revealed over a thousand previously undocumented geoglyphs. The most commonly observed type in this valley system of the Rio Grande is the trapezoidal 'runway' formation that usually runs along flat-topped ridges that rise above the valley floors worn by the seasonal meandering of rivers. The Photogrammetric Reconstruction of the Geoglyphs of Nasca and Palpa Project¹⁴ has digitally modeled the entire Palpa valley area revealing the overriding alignments within the clusters of geoglyphs. Many of the longest trapezoidal runway glyphs run along high ridges that seem to have been artificially leveled before the surface glyphs had been produced. The alignments of the vast majority of these large wide lines point in the very same direction as the beak of the Nazca Hummingbird, east-northeast toward the pyramids of the Giza plateau.

Unique among the varied 'runway' geoglyphs are a grouping of octagonal circular geometric designs atop a rugged limestone ridge, the largest forming a sacred Sanskrit mandala (4.22). This mandala geoglyph is about 7,668 miles from Giza, marking a Fibonacci band resonance at exactly 30.9% of the Earth's circumference distance from the Orion pyramids. The limestone of the Palpa region transduces the focused standing waves of infrasound to electrify the bare feet of entranced groups of meditators circumambulating the many processional patterns and lines. The tri-thalamic group entrainment format induced a collective synchronization within the participants of the spiritual procession to the heartbeat of the Earth, in unison with all other human beings in psychoacoustic alignment worldwide. This format of the Sanskrit mandala is most notably preserved in the temporary sand mandala of Tantric Buddhism, sand paintings of indigenous North Americans and serially depicted in the rich textiles of the Andes.

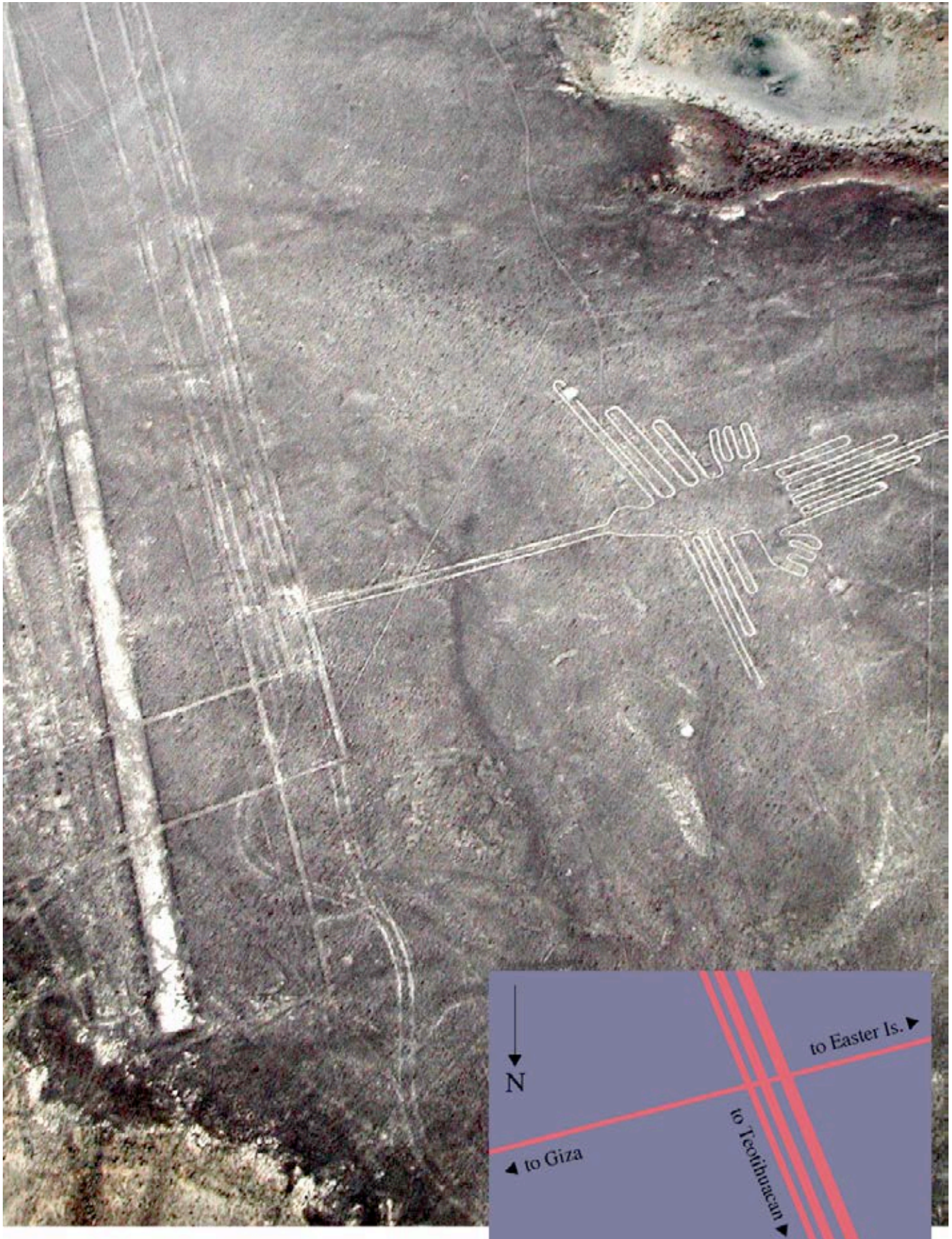

4.21. Nazca's Hummingbird processional pattern presents the sacred alignment to Giza, Teotihuacan and Easter Is.



4.22. Peru's Palpa lines present the octagonal Sanskrit mandala, so well preserved in the religions of India



4.23. Cloth bag made by Chiribaya weavers presents octagonal mandalas of concentric circles and oculate beings

Burial possessions of mummies from the Chiribaya culture of 2,500bp repeat several variations of octagonal mandala patterns including one remarkable woven bag with a nonlinear pattern of circles and the oculate being (4.23). Both the Buddhist and Andean traditions deeply associate this mandala with sacred sound, flight, and psychoacoustic ceremonial instruments like the bi-frequency Chiribaya whistle (4.24, left). Psychoacoustic references, helical DNA snakes and octagonal mandala patterns are repeated in varied designs throughout the Chiribaya museum collection in Ilo, Peru. In every case the sacred patterns are presented in bands of repeatedly reversed two-color icons (as above, for example –we see red circles on a white background next to the same pattern color-reversed with white circles on a red background).

The vertical banding of Chiribaya textile designs creates a visual effect when the patterns are looked across in a horizontal direction, closely mimicking the dipolar oscillation seen in actual satellite observations of this precise octagonal pattern of concentric circles, reversing from positive to negative at 1.45 Hz frequency (4.15). *The ancient Chiribaya designs precisely encode the complex geometry of standing wave resonance that today's computers render using the iterated function [$Z_{n+1} = Z_n^2 \text{ modulo } n$]!* Across the span of several thousand years, the Atlantean spiritual knowledge of four-dimensional physics aligns with the paradigm-



4.24. Banded Chiribaya bi-frequency whistle, woven bag with bands of mandalas and a mummified hand with tattoos

shifting contemporary findings of quantum physics and psychoacoustics. The application of standing wave physics to the study of ancient human culture reveals the world's pyramids and megalithic sites to be components of a unified 'wireless' infrasound network spanning the entire globe, both above and beneath the oceans of the world. The great antiquity of human psychoacoustic architectural technology extends far beyond the reaches of known history, but the crucial mathematical formulas for the planetary resonance patterns defining the positions of the antediluvian pyramid network have been well preserved. Both the stone structures themselves and the encoded indigenous spiritual knowledge were painstakingly preserved *for our very benefit today, as humanity approaches a phase of transformation.*

The mandala cultural symbols encoding the spiritual mathematics of consciousness are so deeply embedded in the collective human memory, having become entirely diffused into the modern world's visual expressions through innumerable variations and yet so directly and powerfully crystallized in the sacred imagery of indigenous cultures. Sacred psychoacoustic instruments and textiles were designed with the same particular symbols that were tattooed on faces, hands and wrists and later preserved by mummification practices along with the DNA records in preserved body tissues (4.24, right).

The overwhelming synchronicity of discoveries in archaeology, quantum physics and psychoacoustics informs a profound new perspective on human culture. While whole languages and indigenous traditions are becoming extinct in many parts of the world, the essential spiritual truths preserved by those traditions are being rediscovered in scientific laboratories. By informing ourselves of ancient cultural practices we can now understand the best applications of quantum physics for the collective human benefit. Science can no longer ignore the giant psychoacoustic machines that sit idle all over our planet. We must recognize that the most advanced technology on Earth is not being used, but waits in the silence that now envelops the world. We don't have to figure out how to build another Great Pyramid –we just have to turn it on! *The beating of a drum at 1.45 Hz in the basement of the Great Pyramid is heard at every sacred site in the world after 2 hours of drumming.*



4.25. Aerial view of the Candelabra sand geoglyph near Pisco, Peru; the Paracas culture's sacred 'tree of life'

Perhaps the most direct visual reference to Great Pyramid of Giza presented in the geoglyphs of the Andean region is the Candelabra, a giant 'tree of life' symbol near modern day Pisco, Peru (4.25). The base of this formation is a bisected triangle presenting the phi geometry of the Giza pyramids, with three parallel lines extending vertically from its corners directly towards Giza. The three straight vertical paths are adorned with branching arms that present the same Fibonacci order as a cactus, likely representing the acoustic energy that accumulates in this resonant area through the pulsations of sacred sound from the Orion pyramids. The quartz sand of the dune is a piezoelectric material, like the limestone bedrock of Nazca, effectively transducing the nonlocal acoustic field at 30.9% of the Earth's circumference distance from Giza. The site marks the western-most continental site through which the Sine Wave alignment passes, also receiving the added low frequency acoustic energy of the ocean's waves. While the Candelabra is best viewed from the air, it is also quite impressive seen from a boat just offshore.

The Paracas culture linked with the Candelabra's origins predated the Nazca culture to the south, whose wide range of imagery does not include representations of this more ancient geoglyph. A line of resonant sacred sites extends south-southeast from this figure along the modern towns of Pisco, Ica, Palpa and Nazca. The Candelabra formation is reminiscent of the Jewish Menorah, a religious symbol that is also depicted with the phi triangle base in its earliest representations, though the base has been replaced with a circular one by successive reinterpretations that inevitably occur throughout the development of tradition. In the Andes however, this nonlinear Candelabra sacred symbol is still deeply associated with the 'world tree': the ancient psychoacoustic 'axis mundi' alignment.

The Chachapoyas ruins of present-day Peru's northern highlands also display psychoacoustic architectural design and symbolism. Kuelap is a thick-walled and terraced enclosure constructed of large limestone blocks, without the use of mortar. The outer wall thickness exceeds 15' in portions and the three entrance points are chasm-like narrow passages less than 10 feet wide in walls over 50' high. Built on a steep narrow ridge, the walls are filled with limestone rubble upon which the interior dwellings are constructed. Plaster was used in layered floors, alternating between stone and plaster, and the walls of the hundreds of 10'-16' circular dwellings were once covered by thatched conical roofs. The design of Kuelap is starkly reminiscent of a bird's wing (4.26), with the entrances slotted into the design as if along the shafts of feathers. The double and single waveform is apparent on many of the circular walls, and in a mirrored format. Both the double waveform representation and the symbolic use of the bird as metaphor for flight, the transmission of the waveform, are present in the design of both Mumbahuru, in Zimbabwe, and Kuelap, in Peru. A clear conclusion can be drawn from this synchronicity: that the builders of the temples on both continents were part of a collective infrasound network, using resonant piezoelectric construction materials for inducing synesthesia. While groups in each continent were obviously using a shared symbolism, it has become apparent they were using the same resonance technology with a shared nonlinear geometric code. The unified technologies of ancient man observed above ground are but a fraction of the resonant spaces that proceed below ground.

Many of the resonant temples among the 127 sacred sites identified here display regional styles and are attributed to cultures whose history is recorded. This work details their knowledge of an advanced technology of infrasonic entrainment of the human mind that has been lost to the modern world, but is still related in ancient spiritual teachings existing today all over the world. In the temple designs we can see a regionalizing of style over time and some of the monuments may have become associated with later cultures. As well, the newer temples may have been built on partial regional knowledge of the infrasonic pattern, or simply were built at the spot where a resonance was perceived. The design plans and consistent use of psychoacoustic symbols of specific animals and double rows of zigzag wave patterns confirms a continuity of Sanskrit culture throughout the ancient world and existing indigenous traditions that share the same technology of the spirit by alignment at sacred sites.

4.26. Aerial plan of the walled limestone Kuelap site, designed as a bird's wing (with entrances numbered)

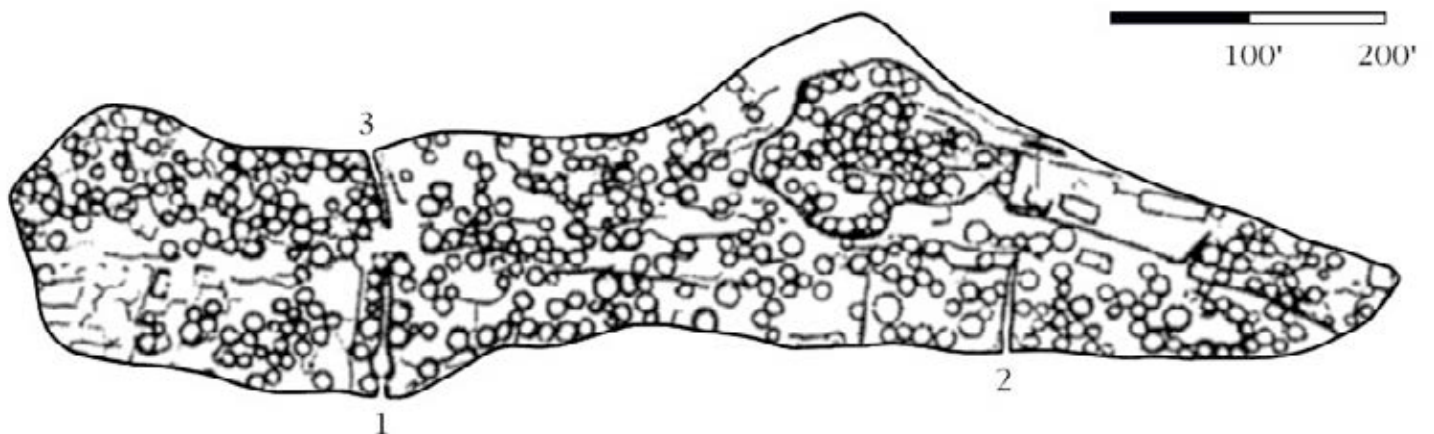



4.27. Great portal at Ollantaytambo, in the sacred Urubamba valley at 30.0% of the Earth's circumference from Giza

Mumbahuru and Kuelap share a construction technology and symbolic referencing of the undulating waveform, the bird, flight, and self-similarity. Their mortarless construction technique is common in advanced ancient stonework and may indicate that some mortarless temples (like Lubaantun) used by the Maya may have been built during the age of the preceding global mother-culture. Hundreds of artifacts have been collected from the Pleistocene Sanskrit culture in clay and stone from every inhabited continent of the world, and their texts can now be readily translated. The nonlinear geometry of this spectacular geopositioned architecture is perhaps a more appropriate language to convey their *unified* principle of consciousness. We have discovered that we are today still using their unit of measurement, the mile, which was calibrated using Fibonacci numbers for convenience in calculating nonlinear infrasonic standing wave distances. The megalithic monuments of the world are components of a crystal reflector system of heartbeat entrainment, each a stunning example of the mathematical precision and cosmic referencing expressed in piezoelectric materials, displaying a collective synesthetic language of four-dimensional geometry.

The incredibly advanced granite stonemasonry of the Andes presents irregular polygonal geometries achieved by complex mold making and stone casting methods. Megalithic architecture reveals its most astonishing evidence of synthetic origin in the complex interlocking polygonal foundations of Machu Picchu, Ollantaytambo (4.27) and Saqsaywaman, where granite stones of gigantic proportions have been seamlessly sewn together. These incredibly advanced technological ruins share much in common with the previously mentioned submerged monument off the coast of Yonaguni Island, and as well with the

megalithic ruins along the ancient Nile River basin to the west of the Giza plateau. The angled walls of megalithic structures provide remarkable stability that has withstood recurrent seismic events of great magnitude. The specific use of granite-hewn aqueduct systems is also a common feature of these widespread ancient sites, allowing water to flow freely through the resonant stones. The use of water as a metaphor for the reflective cosmos is often repeated in these megalithic contexts. Andean sites often include large pools as a visual metaphor, as are also noted at Yonaguni monument and in the Giza Orion pyramids original design, using the waters of Lake Hathor for resonant driving of the 1.45 Hz infrasound cavitation pulse generator.

Modern man has been caught in a divisive mode for hundreds of generations, and indigenous wisdom all over the planet bluntly states that humanity is now emerging from a phase of temporary insanity during which we have collectively lost our self-knowledge. Our current collective quest for memory is perhaps reflective of the magnetic field of the planet that has been waning for thousands of years. The realization of this reconnection with ancient spiritual knowledge is seeded by the sacred Sanskrit mandala of resonance, which was applied to synchronize all of the advanced civilizations of the deep human past. Humanity turns to embrace the truth that ancient psychoacoustic systems unify the patterns of collective consciousness, imploring us to reactivate the 'howling' pyramids that fell silent millennia ago. The theory of Magnetic Resonance extended here can be easily tested by the periodic ultra low frequency stimulation of the Great Pyramid's lower chamber, while infrasound recordings are made at the corresponding resonant sites discussed here. Perhaps more effective is a survey of electromagnetic anomalies that result from the presently fluctuating acoustic environment, one of the goals of the *Timecycle* section of the HumanResonance.org website.¹⁵

The overwhelming Fibonacci accuracy of the world's sacred site alignments is compelling evidence for the contention that the infrasound pattern of Magnetic Resonance *is the mnemonic field of Earth consciousness* –the four-dimensional structure of nonlinear gravitation that ancient Sanskrit teachings refer to as *akasha*. Akasha is the quintessential element from which arise the other elements of earth, air, water and fire. The long wavelengths forming this intricate hidden network exert acoustic pressure, thus increasing the energy flowing through the temples and bedrock. In this way each resonant site in this sacred alignment is endowed with a field of enhanced gravity. This geometric finding provides the elusive key to understanding the deepest applications of quantum physics –gravity is mathematically unified with consciousness as *focused standing waves of infrasound*. The wavelengths of sound to which conscious minds attune themselves is then structurally understood as collective consciousness itself, geometrically rooted in the magnetic North pole and blossoming as the Sacred Tree rising from the Orion pyramids of Giza, Egypt. The enhanced function induced by full biorhythmic entrainment can be described as the threshold of a state of *hyperconsciousness*. The phenomena of synesthetic perception is beginning to take root in the young people of the world and will become eventually extend to the entire human collective once the psychoacoustic temples are reactivated.

The magnetic N pole has recently entered into a motive state unlike any previously recorded by modern man. Its intensity has been diminishing steadily over the last several centuries. Its movement has increased dramatically in the last decade, and has been described by many scientists as being in a weakening wobble probably preceding a magnetic polar reversal, known to have occurred continually throughout geologic history. The current low levels of Earth resonance may be reflected in the collective consciousness of humanity by entrainment, eliciting DNA enhancement by ambient infrasound. The ancient legends of the *golden age*, extremely long life spans and giants may be related to changes in the nonlinear gravitation and resonant planetary acoustics that occurs as a result of the geographic and magnetic polar orientations. The four-dimensional model of Magnetic Resonance can be employed as a framework within which the quantum entanglement of DNA, infrasonic resonance and magnetic polar orientations can be comprehensively understood.

Prime Fibonacci Number Sets that Correlate with Ancient Site Distances

The following is a list of Fibonacci numbers that show an intriguing relationship with prime numbers (highlighted in **blue**) in that *both their values and their placement in the Fibonacci sequence are prime*. With F#**31** we find the first instance where the placement is prime (**31**) but the value is not, as in the case of F#**37**, F#**41**, F#**53** and others. Three consecutive primes, F#**131**, F#**137** and F#359 are the basis for the nine-number Fibonacci segments that describe the ancient site distances from Giza in percent and miles. Resonant distances from Giza to other sacred sites can be described as a percent of Earth's circumference by F#**131-139**. These alignments are also accurately described in miles by F#**353-361**. The proportions of the global site distances are reflected in each Fibonacci number sequence, with dozens of major megalithic site alignments accurately reflecting Fibonacci ordered geositions.

1 : 1

2 : 1

3 : 2

5 : 5

7 : 13

11 : 89

13 : 233

17 : 1597

23 : 28657

29 : 514229

43 : 433494437

47 : 2971215073

83 : 99194853094755497

...

131 : 1066340417491710595814572169 x 10⁻²⁷ = 1.06

132 : 1725375039079340637797070384 x 10⁻²⁷ = 1.72

133 : 2791715456571051233611642553 x 10⁻²⁷ = 2.79

134 : 4517090495650391871408712937 x 10⁻²⁷ = 4.51

135 : 7308805952221443105020355490 x 10⁻²⁷ = 7.30

136 : 11825896447871834976429068427 x 10⁻²⁷ = 11.82

137 : 19134702400093278081449423917 x 10⁻²⁷ = 19.13

138 : 30960598847965113057878492344 x 10⁻²⁷ = 30.96

139 : 50095301248058391139327916261 x 10⁻²⁷ = 50.09

...

353 : 26494272942318589069480525788592273303839335703403521573912286394960106973 x 10⁻⁷¹ = 264

354 : 42868634127888159424995674777973502051063092312442448224088410550266867672 x 10⁻⁷¹ = 428

355 : 69362907070206748494476200566565775354902428015845969798000696945226974645 x 10⁻⁷¹ = 693

356 : 112231541198094907919471875344539277405965520328288418022089107495493842317 x 10⁻⁷¹ = 1122

357 : 181594448268301656413948075911105052760867948344134387820089804440720816962 x 10⁻⁷¹ = 1815

358 : 293825989466396564333419951255644330166833468672422805842178911936214659279 x 10⁻⁷¹ = 2938

359 : 475420437734698220747368027166749382927701417016557193662268716376935476241 x 10⁻⁷¹ = 4754

360 : 769246427201094785080787978422393713094534885688979999504447628313150135520 x 10⁻⁷¹ = 7692

361 : 1244666864935793005828156005589143096022236302705537193166716344690085611761 x 10⁻⁷¹ = 12446

Ancient Sacred Site Coordinates and Fibonacci Relationships

#	Megalithic Site	Coordinates	% Distance	Miles	Circle Fraction
0	Giza Orion Complex	29.97N 31.11E *red denotes magnetic quadrupolar alignment with Giza *prime numbers	0	0	infinity
		F131	1.06%	264	1/100 F353
1	- Petra, Jr	30.19N 35.28E	1.0%	255	
2	- Jerusalem, Is	31.44N 35.13E	1.1%	273	
3	- Luxor, Egy	25.66N 32.70E	1.2%	289	
		F133/2	1.40%	346	1/72 F355/2
4	- Siwa, Egy	29.14N 25.31E	1.4%	350	
		F132	1.72%	428	F354
5	- Ba'albek, Leb	34.00N 36.13E	1.7%	424	
		F133	2.79%	694	1/36 F355
6	- Nemrud Dag, Trk	37.58N 38.44E	2.8%	694	
7	- Okhi, Gr	38.08N 24.45E	2.8%	698	
8	- Acropolis, Gr	37.57N 23.42E	2.8%	705	
9	- Mycenae, Gr	37.60N 22.80E	2.9%	729	
10	- Delphi, Gr	38.41N 23.45E	3.0%	749	
11	- Mecca, Sau	21.26N 39.53E	3.1%	777	
12	- Babylon, Irq	32.75N 44.38E	3.2%	814	
		F135/2	3.6%	896	1/28 F357/2
13	- Ur, Irq	30.57N 46.07E	3.6%	896	
14	- Uruk, Irq	31.35N 45.60E	3.6%	871	
		F134	4.51%	1,122	1/22 F356
15	- Hypogeum, Malta	36.10N 14.10E	4.4%	1,091	
		F131/2	5.26%	1,309	1/19 F353/2
16	- Persepolis, Ir	29.93N 52.90E	5.2%	1,304	
17	- Tassili n'Ajjer, Al	26.32N 9.50E	5.3%	1,320	
18	- Rome, Vatican, It	41.53N 12.30E	5.3%	1,326	
19	- Petridava, Ukr	48.48N 26.35E	5.3%	1,326	
20	- Ma'rib, Ye	15.26N 45.20E	5.4%	1,350	
		F135	6.6%	1,635	1/15 13.2/2
21	- Montevicchia, It	45.90N 9.10E	6.6%	1,635	
		F135	7.3%	1,815	1/14 F357
22	- Glouzel, Fr	45.16N 3.90E	7.3%	1,827	
		F134 x 2	9.0%	2,244	1/11 F356 x2
23	- Stonehenge, En	51.08N 1.49W	9.0%	2,239	
24	- Avebury Henge, En	51.42N* 1.42W	9.0%	2,248	*Lat 1/7
25	- Silbury Hill, En	51.33N 1.40W	9.0%	2,245	
26	- Samarkand Pyr, Uz	39.80N 68.75E	9.0%	2,238	
27	- Moenjodaro, Pk	27.05N 67.15E	9.0%	2,249	

#	Megalithic Site	Coordinates	% Distance	Miles	Circle Fraction
0	Giza Orion Complex	29.97N 31.11E	0	0	infinity
		<i>*red denotes magnetic quadrupolar alignment with Giza</i>			
		<i>*prime numbers</i>			
30	- Gulf of Khambat, Ind	21.73N 72.57E	10.5%	2,620	
31	- Tenerife, Canary Is	28.48N 16.23W	11.4%	2,845	
32	- Khajuraho, Ind	24.85N 79.93E	12.0%	3,002	1/8
27	Khajuraho - Moenjo.	27.18N 68.07E	3.1%	789	
33	Khajuraho - Lhasa, Ti	29.44N 91.12E	3.0%	739	
45	- Bodh Gaya, Ind	24.42N 84.58E	13.2%	3,290	
33	- Lhasa, Ti	29.68N 91.17E	14.3%	3,571	
34	- Mahabalipuram, Ind	12.58N 80.17E	13.5%	3,355	
35	- Konarak, Ind	19.90N 86.10E	14.0%	3,490	
36	- Mumbahuru, Zim	20.05S 30.45E	13.7%	3,413	
37	- Pyay, Th	19.15N 95.05E	16.2%	4,048	
38	- Geographic N Pole	90.00N	16.7%	4,172	1/6
39	- Sukhothai, Th	17.00N 99.85E	17.6%	4,396	
40	- Phimai, Th	15.13N 102.50E	18.4%	4,599	
		F137	19.1%	4,754	F359
41	- Angkor Wat, Cm	13.43N 103.83E	19.1%	4,742	
42	- Preah Vihear, Cm	14.24N 104.40E	19.1%	4,752	
43	- Preah Khan, Cm	13.40N 104.75E	19.2%	4,789	
44	- Geomagnetic North	78.30N 104.0W	19.1%	4,763	
		F136/2	5.88%	1,463	1/17 F358/2
45	Angkor - Bodh Gaya, I	24.42N 84.58E	5.9%	1,461	
46	Angkor - Everest, Ne	27.58N 86.56E	5.9%	1,484	
47	Angkor - Xi'an, Ch	34.15N 108.5E	5.9%	1,474	
48	Angkor - Yonagumi, Jp	24.26N 123.0E	5.9%	1,464	
49	Angkor - Bada Vall, In	1.00S 119.50E	5.9%	1,483	
50	Angkor - Dieng, In	7.12S 109.54E	5.9%	1,489	
51	Angkor - Borobudur, In	7.29S 110.12E	5.9%	1,484	
52	Angkor - C Pawon, In	7.36S 110.13E	5.9%	1,489	
53	Angkor - C Banon, In	7.36S 110.13E	5.9%	1,489	
54	Angkor - C Mendut, In	7.36S 110.13E	5.9%	1,489	
55	Angkor - C Ngawen, In	7.36S 110.16E	5.9%	1,490	
56	Angkor - C Canggal, In	7.38S 110.17E	5.9%	1,490	
57	Angkor - C Sukuh, In	7.38S 111.13E	6.0%	1,513	
58	- Octagon Mound, US	40.10N 82.28W	24.1%	6,000	
59	- Serpent Mound, US	38.56N 83.16W	24.5%	6,118	
60	- Aztalan, Rock Lk, US	43.08N 88.93W	24.7%	6,154	
49	- Bada Valley, In	1.00S 119.50E	24.7%	6,152	

#	Megalithic Site	Coordinates	% Distance	Miles	Circle Fraction
0	Giza Orion Complex	29.97N 31.11E	0	0	infinity
		<i>*red denotes magnetic quadrupolar alignment with Giza</i>			
		<i>*prime numbers</i>			
		F139/2	25.0%	6,223	1/4 F361/2
61	- Itaituba, Bz	4.06S 56.21W	25.0%	6,223	
62	- Yakutat, Alaska	59.9N 138.85W	25.0%	6,241	
63	- Effigy Mounds, US	43.10N 91.15W	25.0%	6,219	
64	- Xingu, Culuene, Bz	13.10S 53.09W	25.3%	6,313	
65	- Turtle Mound, US	29.04N 80.32W	25.6%	6,380	
66	- Cahokia, US	39.00N 89.67W	25.6%	6,369	
67	- Etowah Mounds, US	34.12N 84.80W	25.6%	6,379	
68	- Moundville, US	32.99N 87.63W	26.3%	6,554	
69	- Poverty Point, US	33.09N 91.18W	26.9%	6,705	
70	- Emerald Mound, US	31.45N 91.20W	27.2%	6,782	
		F133	27.9%	6,936	F355
71	- Guanahacabibes, Cba	21.83N 85.15W	27.77%	6,912	5/18
72	- Sutatausa, Col	4.70N 74.16W	28.0%	6,972	
			28.57%	7,112	2/7
73	- Mesa Verde, US	37.25N 108.50W	28.7%	7,143	
74	- Chaco Canyon, US	36.00N 107.00W	28.8%	7,164	
75	- Tulum, Mx	20.21N 87.43W	28.5%	7,104	
76	- Coba, Mx	20.49N 87.72W	28.5%	7,106	
77	- Chichen Itza, Mx	20.67N 88.58W	28.7%	7,142	
78	- Uxmal, Mx	20.22N 89.46W	28.9%	7,206	
79	- Edzna, Mx	19.40N 90.15W	29.2%	7,276	
80	- Altun Ha, Be	17.75N 88.3W	29.1%	7,254	
81	- Tikal, Gua	17.22N 89.63W	29.5%	7,345	
82	- Lamanai, Be	17.68N 88.75W	29.2%	7,280	
83	- Lubaantun, Be	16.30N 88.90W	29.5%	7,347	
84	- Palenque, Mx	17.47N 92.02W	29.9%	7,456	
85	- La Venta, Mx	18.00N 92.55W	29.9%	7,459	
86	- Copan, Hon	14.83N 89.15W	29.8%	7,422	
87	- Yaxchilan, Mx	16.90N 90.98W	29.8%	7,428	
88	- Tazumal, Gua	13.59N 89.33W	30.0%	7,484	3/10
89	- Veracruz, Mx	19.11N 96.10W	30.4%	7,582	
90	- Cochasqui, Ec	0.01N 78.40W	29.7%	7,390	
91	- La Mana, Ec	0.95S 79.18W	30.0%	7,470	3/10
92	- Cuenca, Ec	2.91S 79.05W	30.2%	7,531	
93	- Tiwanaku, Bo	16.55S 68.67W	29.5%	7,351	
94	- Saqsaywaman, Pe	13.52S 72.00W	29.9%	7,456	
95	- Pisac, Pe	13.26S 71.51W	29.8%	7,418	
96	- Ollantaytambo, Pe	13.15S 72.16W	30.0%	7,472	3/10
97	- Machu Picchu, Pe	13.12S 72.58W	30.0%	7,478	3/10

#	Megalithic Site	Coordinates	% Distance	Miles	Circle Fraction
0	Giza Orion Complex	29.97N 31.11E	0	0	Infinity
		*red denotes magnetic quadrupolar alignment with Giza *prime numbers			
		F138	30.9%	7,692	F360
98	- Nazca, Pe	14.83S 74.95W	30.9%	7,673	
99	- Cahuachi, Pe	14.48S 75.10W	30.9%	7,679	
100	- Tambo Colorado, Pe	13.38S 75.46W	30.9%	7,694	
101	- Paracas, Pe	13.34S 76.12W	30.9%	7,697	
102	- Pachacamac, Pe	12.13S 76.52W	30.9%	7,710	
103	- Marcahuasi, Pe	11.46S 76.34W	30.9%	7,680	
104	- Caral, Pe	10.54S 77.31W	30.9%	7,710	
105	- Sechin, Pe	9.26S 78.13W	30.9%	7,702	
106	- Chavin de Huantar, Pe	9.53S 77.10W	30.7%	7,636	
107	- Chan Chan, Pe	8.08S 79.07W	30.9%	7,707	
108	- Moche, Pe	8.06S 78.56W	30.9%	7,695	
109	- Kuelap, Pe	6.24S 77.54W	30.3%	7,543	
110	- Laguna Condores, Pe	6.40S 77.10W	30.3%	7,533	
111	- Tucume, Pe	6.51S 79.85W	30.9%	7,702	
112	- Mitla, Mx	16.55N 96.24W	30.9%	7,680	
113	- Monte Alban, Mx	17.50N 96.75W	30.9%	7,688	
114	- Cuicuilco, Mx	19.26N 99.09W	30.9%	7,699	
115	- Cholula, Mx	19.04N 98.18W	30.8%	7,669	
116	- Teotihuacan, Mx	19.68N 98.83W	30.9%	7,684	
117	- Tula, Mx	20.03N 99.20W	30.8%	7,669	
118	- Tenochtitlan, Mx	18.85N 99.35W	31.1%	7,748	
119	- La Quemada, Mx	22.25N 102.49W	31.0%	7,721	
120	- Uluru (Ayers Rock), Aus	25.22S 131.03E	30.6%	7,617	
121	- Lk Vostok, Antarctica	78.45S 106.43E	32.1%	8,007	
122	- Geomagnetic S Pole	74.12S 126.36E	33.2%	8,265	1/3
123	- Geographic S Pole	90.00S 0.00E	33.2%	8,274	
			40%	9,956	2/5
124	- Easter Island, Ch	27.12S 109.40W	40.3%	10,044	
125	- Anatom Island, Vn	20.10S 169.48E	39.3%	9,802	
126	- Waitapu, NZ	36.0S 173.5E	41.0%	10,212	
	Waitapu - Giza antipode	F134 x 2	9.0%	2,244	1/11 F356 x2
127	- Opunohu, Moorea, Fr	17.32S 145.45W	46.4%	11,553	
	Opunohu - Giza antipode	F135/2	3.6%	893	F357/2
	Angkor Wat - Nazca	F139	50.0%	12,446	F361

References

- ¹ Munck C (1997) *'The Code-1997'* Radio Bookstore Press, online
· <http://www.pyramidmatrix.com/index.htm>
- ² Alison J (2002) *'A New Look at Old Design: The Alignment of Prehistoric Sites'* online
· <http://home.hiwaay.net/~jalison/>
- ³ Hapgood C (1970) *'The Path of the Pole'* Chilton Books
- ⁴ Forgione A (2003) *'Malta: The Skulls of the Mother Goddess'* *Hera Magazine*, online
· http://www.gizapyramid.com/adriano_forgione.htm
- ⁵ Matejka J (2003) *'Italská Giza - Montevécchia / Tre Piramidi'* *WM Magazine*, online
· <http://www.mwm.cz/CD/c1184.htm>
- ⁶ Kiseleva Y, tr. Solovieva V (2000) *'So, Pyramids, or Something Else?'* Pravda.RU, online
· <http://english.pravda.ru/main/2002/06/19/30639.html>
- ⁷ Mutwa C (2000) *'Song of the Stars: the Lore of a Zulu Shaman'* Barrytown Ltd
- ⁸ Hancock G (2004) *'Preliminary Underwater Archaeological Explorations of Mahabalipuram'* online
· <http://www.grahamhancock.com/underworld/underworld5.php>
- ⁹ Steadman K (2002) *'Pacific Radar Anomaly'* CyberspaceOrbit.com, online
· http://www.cyberspaceorbit.com/pacific_anomaly.html
- ¹⁰ Bourke P (1990) *'Circle Squares Fractal'* University of Western Australia, online
· <http://local.wasp.uwa.edu.au/~pbourke/fractals/circlesquares/>
- ¹¹ Men H (2002) *'Magnetic Activation of the Pyramids Through the Crystal Skulls'*, Human Resonance, online
· <http://www.human-resonance.org/activation.html>
- ¹² Heckenberger M (2004) *'The Ecology of Power: Culture, Place and Personhood in the Southern Amazon, AD 1000-2000 (Critical Perspectives in Identity, Memory & the Built Environment)'* Routledge
- ¹³ -- (2004) *'Morien Institute Interview with Dr. Paul Weinzwieg'* Advanced Digital Communications, online
· http://www.morien-institute.org/interview1_ADC.html
- ¹⁴ Sauerbier M, Lambers K (2003) *'A 3D Model of the Nasca Lines at Palpa (Peru)'* *International Archives of the Photogrammetry, Remote Sensing and Spatial Information Sciences XXXIV-5/W10*, online
· http://www.photogrammetry.ethz.ch/tarasp_workshop/papers/sauerbie.pdf
- ¹⁵ Putney A (2005) *'Resonance Timecycle'* Human Resonance, online
· <http://www.human-resonance.org/timecycle.html>



5
Sanskrit Aztlan

Sanskrit Aztlan



5.1. Logographic Sanskrit tablets from Glozel, France and Rotan, Texas

A growing number of collections of stone and metal artifacts from many parts of the globe can only be categorized as '??'. Some anomalous artifacts cannot be included in museum displays without undermining the authority of the institution. Some of these artifacts directly contradict the notion of modern technological advancement, instead forcing an admission that we do not understand the high technology of ancient people strewn all around us in megalithic architecture. Only if one accepts that ancient humanity attained a technological knowledge far greater than today, can one open the door to learning from our advanced ancestors of the deeply veiled past. Yet the acceptance of this fact by the discoverers and private collectors of anomalous relics has preserved a small portion of ancient cultural knowledge outside of museums. Testing done on these items can certainly provide more details.

Comparative study of these disparate collections has revealed startling commonalities that in themselves form the basis of a previously unrecognized cultural context. Some basic similarities are found among many unattributable artifacts: they are made of stone, ceramic or metal, and have been discovered in underground tunnel systems. These factors present a host of problems for modern scientific analysis. Stone and metal objects are inherently difficult to date, although continual advancements in dating methods provide new possibilities yet to be applied. While scientific institutions ignore these unusual finds, independent researchers attribute them to a global antediluvian civilization – Atlantis, or Aztlan.

Discoveries made in caves or underground tunnels deny the easy stratigraphic information provided by placement in geologic layers, yet can allow for millennia of exquisite preservation in sealed chamber environments where weathering is not a factor. Subterranean finds also beg the question: were the artifacts purposely hidden underground for preservation, or did inhabitants of the tunnels use these artifacts in situ? Both scenarios likely contribute to the abundance of these anomalous finds, though convincing evidence is rarely collected to support either hypothesis. This is certainly true of the enigmatic collections described here, yet their precise designs confer a wealth of information regarding the complex nature of advanced ancient technology. As archaeological studies have expanded globally, new cultural links have been understood to provide cultural contexts for these unusual artifacts. A telegram-style script has been found on ancient stone and ceramic tablets in Malta, at Tal Qadi temple; Glozel, France; Alvao, Portugal; Fuenteventura, Canary Islands; Indus Valley, Pakistan; La Maná and Cuenca, Ecuador; Sutatausa, Colombia; as well as Illinois and Texas in the US. The worldwide distribution of sites and Neolithic origin of the hundreds of artifacts reveal an astoundingly advanced worldwide civilization.

The ceramics from Glozel, France (5.1) have been consistently dated to the Magdalenian period of the ice age approximately 16,000bp, and those from the Illinois cave have also been confirmed as many thousand years old by thermoluminescence testing of quartz sand in the clay.¹ German linguist Kurt Schildmann has been able to decipher the logographic characters. The script's similarity to early Sanskrit, when compared to the Magdalenian dates of the Glozel tablets, provided for Schildmann's designation as logographic pre-Sanskrit. This strong body of evidence elucidates the previously inexplicable occurrence of sub-Himalayan cultural practices in southern Africa, or the Andes. The records of ancient Sanskrit traditions have been protected in the millennia since their creation and their extant traditions find many forms throughout the world. Schildmann has concluded that they are our "only authentic source for evaluating a decisive phase of humanity's history that preceded all other recorded phases such as in cuneiform Sumer or, hieroglyphically attested, in Egypt..."² This most ancient form of script must belong to a culture with global communication and transportation, capabilities necessary for its preservation in a globally consistent form. The mother heritage of a global culture was thus passed down in the ancient Sanskrit writings collected in the Vedas, books recording knowledge that had been preserved from ancient times by primarily oral traditions. Sanskrit wisdom traditions were practiced globally before a flood-wave of cultural collapse, after which the kundalini teachings were primarily preserved in the temples of Southeast Asia.

There is a huge difference between texts in authentic paleographic writing and those based on oral tradition. Here now Indus and Burrows Cave texts versus Vedic and Classical Sanskrit literature, the latter recorded after millennia of oral tradition. The former ones are written in their own original script (Indus deciphered 1994, Burrows Cave [Illinois] deciphered 1997), both composed in archaic Sanskrit, in telegram style, while the subsequent later ones reached recording in an already sectarian India, having suffered from mystification, adaptation [and] poetical manipulation...

Schildmann clearly distinguishes between the ancient Sanskrit logographic script (with its descendent forms seen in the cultures of Egypt, Sumer and the Maya) and the Classical Sanskrit and contemporary alphabetic scripts. While the logographic style is literally a 'picture word' that incorporates images from reality, the alphabetic style draws its characters from a totally abstract realm of otherwise meaningless letters. Anthropologist P. Radin poignantly characterizes the holism of the paleographic mind by contrast with the modern literary mind: "the disorientation in our whole psychic life and in our whole apperception of the external realities produced by the invention of the alphabet, the whole tendency of which has been to elevate thought and thinking to the rank of the exclusive proof of all verities, never occurred among [indigenous] peoples."⁴ The simplicity of the logographic Sanskrit script is strongly contrasted by the complexity of their geometrically designed stoneworks, suggesting that *geometry* was their central sacred language. The holistic intertwining of language with geometry is repeatedly seen.

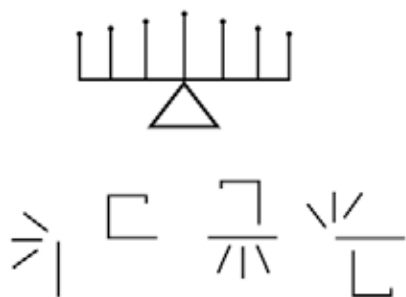

u la - pa a.ś-r^au^a Vi-iṣ-nu

a murmur whispering inaudibly, Vishnu

Dozens of paleographic Sanskrit texts deciphered by Schildmann include pyramids, octagonal mandalas and various references to infrasound standing waves. One poignant reference to infrasound from Burrow's Cave, Illinois, includes a candelabrum with a pyramid base that is quite reminiscent of the Hebrew Menorah, also seen in various other stones from the collection. Presented at left, Schildmann provides the translation: "a murmur whispering inaudibly, Vishnu."⁵ As Vishnu is the 'World Giant', his head the sky and his body the globe, we can understand this inscription as a reference to pyramids resonantly focusing terrestrial infrasound, which is *inaudible* to normal human perception. The prime number 7 is seen in the candelabra structure emanating from the pyramid – a number associated with Jupiter, encoding the planet's synodic year of 399 days as $7 + 7^2 + 7^3$ ($7+49+343 = 399$).⁶ Prime numerical relationships serially encoded in these ancient Atlantean texts reference the holographic capacity of human minds operating in psychoacoustic resonance.



5.2. Engraved stoneworks from Illinois present logographic Sanskrit script, octagonal mandalas and a kundalini cobra

In various other inscribed masterworks from Burrow’s Cave we find further unmistakable evidence of a worldwide Sanskrit kundalini culture. One engraved stone actually places the octagonal mandala on a hemispheric protrusion to suggest its application to the spherical form of the planet (5.2, left). On this same stone we find the *tridaśa* symbol –three horizontal lines connected by a central vertical line, the sign for ‘30’– a likely reference to the ‘30 resonances’. Dr. Schildmann’s cipher provides the reading:

kar-rahā kar-as ka-ma-aśu-hā kar-as
 ta nau-ca ka tridaśa-aśu
 ha-māi ka-hā si-hā
 u tridaśa Indra aśu-hā tridaśa
 ta cakra ca-kar-as mahā

“Creator of the action of desires in this life, its workings”
 “The (space-)ships of the 30 resonances of life force”
 “Causing a dwindling of these (forces) you are”
 “Oh, 30 resonances, Jupiter’s life-giving 30 resonances”
 “The celestial wheel and workings of the great”

Incised into another stone from Burrow’s cave site is a hooded kundalini cobra (5.2, right), the sacred snake native only to Southeast Asia, representing the coiled energy cord that rises through the spinal column to the crown chakra in deep meditative states induced by infrasound at sacred temple sites. On either side of the cobra are the symbols for *cakra*, the ‘celestial wheel’ or chakra –the vibratory centers of the body. According to Schildmann’s epigraphic cipher, the two vertical texts read: *ra-ka-si* “granted this you are” (at left), and *ya-su-ma* “(here) begins my good path” (at right). The horizontal text below the kundalini cobra reads: *ai kara-as Indra a-asu* “yes, the works of Jupiter granting life.” The Great Red Eye vortex of Jupiter symbolizes the ‘third-eye’ of Sanskrit traditions linked with the Orion pyramids’ infrasound resonance. The transduction of infrasound acoustic energy through resonating stone chambers into the meridians and electromagnetic fields of the human body allows an adept, or *yogi*, to generate *laghima*, a Sanskrit term for the body’s vital force that allows levitation when focused by will.



5.3. Illinois cave stone engraved with a map of the Mississippi River valley's mound culture, sites denoted with archways

Perhaps the most astounding stone artifact from Burrow's Cave, Illinois is engraved with a complete map of the Mississippi River valley (5.3). In its smoothly carved forms can clearly be seen the Gulf coast, Lake Pontchartrain and the main Mississippi tributaries –the Black River; the Arkansas; the Wolf; the Missouri and Platte; the Ohio, Wabash and Little Wabash; and the Illinois River (flowing towards the cavesite). Distances between the river junctures are given in numerical form with dots and lines, while several Sanskrit sacred sites are also denoted. One earthen mound site is shown to the west of the Mississippi, while along the Ohio River two archways describe the locations of the riverside Cave-In-Rock (near Elizabethtown, Illinois) and the Garden of the Gods, a great sandstone outcropping of unusual, flowing forms including various towering, totem-like pinnacles.

Near the two sacred sites, depicted as archways, a subtext reads: *vi-ra tsa-pa, t.o.ra-na* "hero trembling, arched portal." ⁷ The resonant limestones of Cave-In-Rock and sandstones of the Garden of the Gods, comprised of calcite and quartz respectively, are receivers of focused infrasound pulsations –kundalini energy that induces the 'hero trembling'. Cave-In-Rock (37.46°N 88.16°W) and Garden of the Gods (37.63°N 88.37°W) are both 6,360 miles from Giza, or 25.55% of the Earth's circumference distance. The Mississippi Map stone details a network of resonant cave sites in infrasound alignment.

In a related find from 1872, a highly geometric Sanskrit stone carving was discovered in a farmer's field in Meredith, New Hampshire (5.4).⁸ The brown stone is a precisely hewn egg form (4" x 2.5") covered with various Sanskrit sacred symbols. Drilled holes are found at the top and bottom of the egg; evidence that it was turned on a lathe – a complex machining process that allows for the precision of symmetrical form by rotation. The egg form shows a human face in meditation, representing the sacred effects of fetal development by infrasound heartbeats: the power of the circle nurtures all life. Above the circle we see a pyramid shining light from its peak. On the reverse side are two crystal diffraction patterns and a spiral.

5.4. Sanskrit lathe-turned stone carving with a face, circle, spiral and other geometric symbols, from New Hampshire





5.5. Vertically-elongated, giant humanoid skull from Mexico compared with Rapa Nui's giant Moai statues
 5.6. (Opposite) Entrance, geometrically engraved ceiling panel and giant skeletons from an Oklahoma cave

An altogether different subterranean system at an undisclosed location in southern Oklahoma has yielded the textile, wood, stone and metal artifacts of giant humanoids over nine feet in height (5.6). Two fully intact male skeletons have been documented along with the oval cave entrance and a geometrically engraved ceiling panel that depicts the Sanskrit octagonal mandala.⁹ The unusual anatomy of the giants' skulls distinguishes them as a completely separate species of humanoid, showing a significant variance from human norms in every bone. Unmistakable similarities can be observed in the forms of an artificially elongated skull from a cave find at an undisclosed site in Mexico (5.5, left), with hooked protrusions at the temples, a very square, protruding lower jaw with no chin, narrow eye sockets and huge nose with an extra nasal bone not found in humans. The extreme vertical elongation is made even more pronounced by the miniscule occipital portion of the skull that extends only marginally beyond the mastoid processes. The distinctive facial architecture of this giant humanoid species may have inspired the giant Moai statues of Rapa Nui, also known as Easter Island, that bare the same giant stature, giant noses, square jaws and vertical crania. The genetic make-up of this giant humanoid species will eventually be revealed by DNA retrieved from organic residue in the bones, inevitably exposing any mixing with human populations.

In 1960, J. Padilla discovered a set of fine artifacts within a tomb near Guerrero, in Oaxaca, Mexico (5.7).¹⁰ Several small gold plates engraved with Archaic Sanskrit texts were among the collected artifacts, further confirming Schildmann's epigraphic research. While this style of telegram is much more fluid than the harsh geometric symbols made famous in finds near Glozel, France, the same advanced Sanskrit heritage is apparent. Despite the lack of a complete translation of this text, we can clearly make out symbols relating to global infrasound resonance—in the top row a double soundwave, a line with hash-marks implying measurement and a hemisphere with concentric circles; in the middle row, at left, is a hemispherical head turned sideways with three arcs representing infrasound reception. As well, the sign seen at the center of the bottom row presents a nonlinear standing wave pattern with three lines above, representing the tri-frequency resonance by which such standing waves are generated.

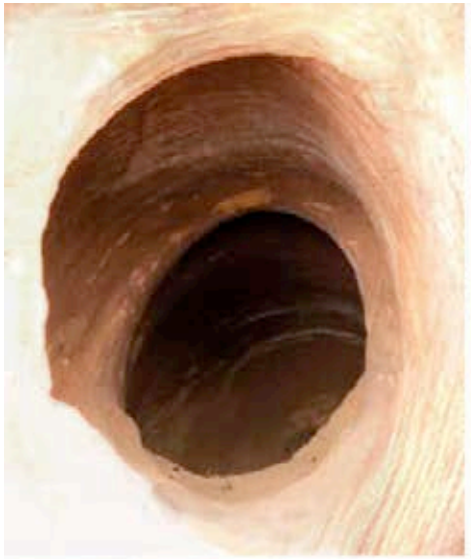



5.7. Sanskrit scripts adorn gold plates from Guerrero, Mexico, and an elephant listening for infrasound in the Earth 5.8. (Opposite) A copper plate from cave systems near Cuenca, Ecuador depicts standing waves and DNA ladders

Similar infrasound references are presented on a gold disc formed like a water droplet (5.7). Surprisingly, the disc depicts an elephant—an animal not native to Central America, but to Africa and Asia—in a standing position that is truly specific in its implications. Modern biology has only recently rediscovered the elephant’s use of infrasound communication over vast distances. The ultra low vocalizations of these large pachyderms can carry around the globe coherently, and are used to send messages between herds across the great continent of Africa. Biologists have only recently filmed elephants standing with a front foot touching the ground only by the sensitive toenails, just as positioned on the Guerrero gold plate! The ancient Sanskrit artists of Oaxaca have depicted the inaudible infrasound signal as zigzag waveforms traveling through the ground to be received through the elephant’s toenails. The ancient Vedic hymns reflect this same advanced use of natural logic and symbol to express highly complex concepts.

Another famous collection of antediluvian Sanskrit artifacts is known from Cuenca, Ecuador, under the protection of a priest, Padre Crespi, now deceased. The very large group of figurative artifacts includes worked bones, ceramics, stones and many engraved copper plates. Various sizes of plates include many images of pyramids, snakes, elephants, skeletons, healers and meditating figures, some even large enough to be worn as ceremonial chest-plates. The most remarkable of these hammered copper sheets presents a fascinating visual description of the Sanskrit kundalini process of bioelectrification using sacred ayurvedic water (5.8). The barefoot figure wears a headband with a radiant circular face at the third-eye location. *Above the circle are arching cloud-forms in the unmistakable shape of standing waves.* On either side of the figure rise double-headed serpents that make waves along a column of evenly spaced circles. The sacred ayurvedic process of drinking purified colloidal water containing nanoparticles of gold and silver, a combination known as *electrum*, to conduct subtle curative electrical currents through the human body. The serpents represent the electrical current rising through the chain of spherical nanoparticles, creating waves of movement up the figures legs and his spinal column. DNA strands are also seen on either side of the kundalini figure, like straight ladders also shown as electrified by zigzag lines. Recent studies show DNA to be helical only in fear states, but like a ladder when at peace.¹¹





5.9. The Embryology Disc (bifacial) presents an octagonal mandala that depicts all the stages of fetal development
 5.10. Acupressure tools formed as a patient and a reclining chair, and a set of fine stone acupuncture instruments

While its script can now identify the ancient intercontinental Sanskrit culture, its remnants also include many truly complex tools that belie the simplistic look of their texts. A large group of stone artifacts of the Gutierrez collection discovered near Sutatausa, Colombia attest to the fundamental biological knowledge of Aztlan. The most remarkable of these stone-works is a visual narrative on a disc to be read by rotation on an axle, the Embryology Disc (5.9), named for its thorough depictions of fetal development from conception itself. The stone is bifacially worked, with each side divided into a circular storyboard based on an octagonal symmetry, a defining sacred mandala geometry that is also seen on the Rotan, Texas Sanskrit tablet (5.1) accompanied by the prime number 29. One face of the disc (at left) depicts the two sexes and genital forms, sperm and a twelve-part sequence of fetal development from the single cell. The disc's opposite face presents the sperm having eaten the egg, the expanding uterus, cellular mitosis

(in the dot sequence one-through-four), and chromosomal separation. The disc is crafted from Lydite, a hard but extremely brittle stone. The vibration of modern machinery consistently shatters Lydite, suggesting that the forms of the disc were not achieved through cutting or chiseling methods.

An astounding alternative stone-working technique of chemical disaggregation has been documented by J. Davidovits at the Geopolymer Institute, and is still in use among Amazonian cultures today. The Huanka culture of the Peruvian rainforest formulates an oxalic acid extract from rhubarb leaves and several other constituents that is used to dissolve and thereby shape stone. Davidovits' electrochemical analysis of stone fragments from the monumental Gate of the Sun at Tiwanaku, Bolivia, revealed molecular structural changes specific to having once been in a liquid state. Further testing revealed traces of alkaline mineral reactants, such as oxalates, confirming the stone to be synthetic. Chemical disaggregation is the only technique that could have been employed in the creation of the Embryology Disc, or any of the other Lydite artifacts of the Gutierrez collection. The Embryology Disc comprehensively details the cellular details of human procreation, a knowledge accessed by contemporary science only through advanced microscopy. The disc's starkly accurate imagery may not have been obtained by any instrument other than the human mind itself; its synesthetic potential having perhaps been achieved through acoustic entrainment techniques during the developmental stages of the fetus and newborn infant. The octagonal structure of the disc's visual narratives suggests a link between optimal embryological development and the octaves of sound, as do other artifacts to be discussed.

A variety of advanced stone surgical instruments were also found at the Sutatausa site, carved in beautifully flowing forms including anthropomorphic and zoomorphic figural references. The bat is represented in the handle forms of two surgical tools, a sacred creature due to its sophisticated psychoacoustic sense of echolocation. All of the needlepoint or bladed instruments are designed with balance and utility in mind, having ergonomic handles created by protruding bulbs, symbolic forms that resemble animal or human shapes in their symmetry –including bats, cats, and birds.



5.11. Blunt umbilical knife and a gynecological spoon

Other instruments have handled forms that portray gynecological functions (5.11); one bladeless, pointed knife was used to free an entangled fetus as its handle was carved to show the umbilical cord wrapped around the baby's neck. One spoon-like speculum has a handle carved in the form of a woman spreading her legs for an examination. These human representations among the Sutatausa artifacts consistently depict simplified round heads and wide circular eyes, regardless of gender or age. These features are most clearly presented in a reclining figure in stone (5.10, bottom), seated on something similar in appearance to a modern dentist's chair. Whether the figure is a representation of an ailing patient or perhaps a stargazing astronomer remains an open question, yet the stone's smooth flowing forms evoke a feeling of calm, mystical awe and observation. The refined surfaces of this seated figure also suggest it was shaped through the use of alkaline reactants. These are paired acupressure tools that fit perfectly into the palm of the hand to administer pressure to the reflex points of the body in the relief of pain and energy blockages. Six tiny needlepoint acupuncture tools were also found among the fine artifacts from Sutatausa, including animal inspired forms and one shaped as a sperm cell. Once again, the complex microbiology details are strikingly accurate.



5.12. Sanskrit-engraved stone from Sutatausa, Colombia, and a ceremonial axe with a male fertility motif –sperm

The same flowing contours are beautifully rendered in the forms of a ceremonial hand axe formed to represent several tadpole-like sperm cells (5.12, right). The anthropomorphic sperm cells snake dynamically over the surfaces intertwined, their heads forming a handle opposite the blunt axe-head. The sensitive Lydite stone axe's forms must also have been dissolved with acids, and is considered a ceremonial axe as it would shatter if practically used. Another small black polished stone artifact from the Gutierrez collection is engraved with logographic Sanskrit geometric characters that have yet to be clearly deciphered (5.12, left). The largest symbol is a bisected circular design that reflects the ancient mathematical symbol for ϕ – \emptyset – and the more complex structure of Magnetic Resonance (5.12, inset). The smoothly flowing forms of all of the stone masterpieces from Sutatausa, Colombia were achieved using advanced chemical disaggregation technologies that reflect the same high degree of knowledge expressed in the symbolic forms of the various delicate instruments. The Sutatausa collection is an exquisitely detailed group of fertility tools encoding a wealth of visual information on the advanced fertility knowledge of the Sanskrit world nation. Clearly the Atlantean kundalini traditions are part of an unrecognized collective consciousness technology based on the infrasound wireless pyramid network.

Many Neolithic stone and metal artifacts from Africa have also been found to use the same symbolic kundalini language of the geometry of resonance. Referred to as Nomoli, groups of small figurative stone statues have been discovered in South Africa that include references to kundalini concepts. One Nomoli figure is shaped as a kneeling woman whose body is covered in patterns of concentric circles on her shoulders, breasts and on her cheekbones. Like the ancient portraits of the Maya of Central America, the area of the third-eye is shown to be pronounced by a ridge to suggest high spiritual development, while concentric circles are also inscribed into the back of the head and in patterned headdress. Three lines extend from the circles on the cheeks upwards towards the eyes, and extending horizontally from the concentric circles in her headdress, represent the tri-frequency resonance of biorhythmic entrainment at Sanskrit sacred sites where concentric energy rings are formed by focused infrasound standing waves. The Nomoli artifacts were discovered at sites in alignment due south of the Orion pyramids of Giza, Egypt, as is Zimbabwe's Sanskrit temple of Mumbahuru, meaning 'the Great Woman'. Metal spheres from Ottosdal, South Africa also reflect the structure of resonance. A male Nomoli figure from Sierra Loene presents fangs and scaly reptilian skin (5.14), wearing a crown shaped as the double helix of DNA.



5.13. Female Nomoli figure from Sierra Leone with concentric circles, and two of the ancient metal spheres from Ottosdal



5.14. Male Nomoli stone figure with bulging reptilian eyes, fangs and scales wearing a helically formed crown



5.15. Sanxingdui, China –a jade hoop and two bronze portraits of reptilian humanoids, one wearing a helical crown
 5.16. Bronze vessel with handles formed as trumpeting elephants, and an oxidized ceremonial reptilian mask with bulging eyes and a trail of vapor rising from the nose (inset: Tláloc, Mayan God of Celestial waters, vapors)





5.17. Sanxingdui Sacred Tree with helical two-headed serpent

The unusual anatomy of these reptilian figures has been consistently recorded in ancient sculpture from many parts of the world. An intense group of stone, clay, bronze, ivory and gold artifacts from Sanxingdui, China¹² includes masks and portraits of these reptilian humanoids, with huge almond-shaped eyes, wide, grinning mouths and also with a crown of helical form (5.15). The ancient cache of Chinese artifacts also includes a set of large bronze bells comprising a whole tonal scale, as well as a large bronze urn with handles in the form of trumpeting elephants (5.16, left) representing the force of infrasound resonance, as seen earlier among the Sanskrit metalwork of the Yucatan. Several ceremonial bronze masks from Sanxingdui also show remarkable similarities to the Mayan sculptural depictions of Tláloc, the God of celestial waters, in the detailed rendering of a trail of vapor rising from the nostrils of reptilian figures (5.16, right). This unusual detail suggests a shared cultural symbolism yet to be completely understood. The most impressive bronze piece from Sanxingdui is a gigantic *Sacred Tree* (5.17) composed of dozens of detailed component parts reassembled by museum archaeologists to its impressive original height of over 25'. The central vertical column of the tree blooms with large arching standing waveforms at intervals along its great height. Rising in majestic undulations along the tree is a double-headed helical serpent in the form of DNA, with concentric circles for eyes.

The Sacred Tree is a special symbol seen throughout the indigenous teachings of the world as the *axis mundi* or *world tree* that sprouts from the center of the mandala. Often described as giant trees that shelter all of the children, the bronze Sacred Tree found in Sanxingdui, China contains many layers of 'branches', all of which take the identical arching form of a standing wave, and suspend tiny bronze bells and birds that are unmistakable psychoacoustics symbols. The ancient Sanxingdui, China site (30.95°N 104.32°E) sits in resonant alignment along the same latitude as the Orion pyramids of Giza, Egypt. The Sacred Tree is an acoustic map of invisible standing waves of infrasound used for the enhancement of DNA through the practice of kundalini meditation. The Maya culture painted murals of the Sacred Tree in their pyramids, just as Native American cultures built earthen pyramids and painted sand mandalas of the Sacred Tree flowering at the center of the Hoop of the Nation. Also found both in Sanxingdui and in Mesoamerica are giant stone spheres that were artificially formed and induced to levitate along standing waves of infrasound in ancient times. The spherical shaping of the giant quartz-rich stones allowed them to efficiently absorb acoustic energy and create their own magnetic field, achieving weightlessness.

A group of highly polished ceremonial stone blades are among the impressive cultural remains of Sanxingdui, many of them carved from jade and other fine-grained stones (5.18). Found among many large knives with wide blades, the two largest blades form impressive short swords. Several of the masterworks have been shaped as forked blades terminating in two razor-sharp points. The blades' delicate forms indicate a fragility that would deny any practical utility as weapons for battle, suggesting a ceremonial purpose. The demonstrated mastery of metalworking seen in the many cast-bronze artifacts confirms this hypothesis, yet no metal blades have been described among these Chinese relics.



5.18. Jade blades from Sanxingdui form swords, knives and an axe



5.19. Black-skin jade figures in meditation, one male and one female, and a feline mask with double-headed serpent

Another astonishing set of discoveries was made below the Chinese Inner Mongolian prairie by Korean archaeologist Xiao Jing Jin Xi Yong in the July of 2006. After 16 years of field work in the region, Jin located a clustering of subterranean sites containing a remarkable variety of spectacular jade statuary:

In a giant stone chamber grave there were dozens of fine peerless black jade beast and human statues facing a skeleton as if expressing some kind of awe... These statues' semblance is a rough and hard shell, inside is Hsiuyen jade ("black-skin jade" for short). Besides an insect, all the human, god and beast statues assume a half-erect shape with curving knees... The skeletons also assume a curving posture. In the tomb innumerable chipped stone implements from the Paleolithic period are laying around...

After Mr. Jin's survey, he estimated the number of these kinds of tombs possibly reaches several hundred, distributed across the 50 square kilometer prairies. These tombs are buried several meters deep; above them is volcanic ash. Tens of kilometers away is a giant crater. These black-skin jades are similar to Chinese "Hong Shan Culture" from [Sanxingdui] 5000 years ago, but the scale, artistic detail, and variety surpass those previously seen. If the age of the black-skin jade places it after Hong Shan Culture, why were massive paleoliths found in the tomb. Moreover according to the people's preliminary analysis, the age of the black-skin jade has about 10,000 years history.¹³

The great antiquity and volcanic layering above the sites confirm their antediluvian origin, and the staggering number of such giant subterranean chambers demands a more complete survey and an extensive photographic documentation that includes both the stoneworks and the extensive skeletal remains interred. Aerial radar survey will inevitably reveal the full extent of this advanced subterranean



5.20. Female figure finely rendered in black-skin jade

civilization, yet photographs of the few artifacts published reveal Archaic Sanskrit cultural symbols as described from other continents during antediluvian times. An impressive Hsiuyen jade mask with large feline eyes wears a double-headed serpent crown with horizontal banding surrounding a central circle (5.19, center) –a kundalini reference already described in the copperwork of Cuenca, Ecuador (5.8, page 102). The feline symbolism is a psychoacoustic reference to the purring of cats, like the Sphinx, while the three horizontal lines on each cheek reference the tri-frequency entrainment already described in Andean psychoacoustic masks and panpipes (2.12-2.16, pages 29-34).

The large group of ancient jade sculptures from the Inner Mongolian chambers include a man and a woman with long hair and large ears; their hands on their thighs and eyes closed in meditation (5.19). The figures' awkward position, with half-bent knees and upright torso, is repeated in all of the human representations including another jade female figure displaying a fierce facial expression (5.20). This particular statue is strikingly similar to South Africa's Nomoli stone figures (5.13–5.14, pages 106-107), showing the same disproportionately short legs and body position. Sanskrit tri-frequency entrainment symbolism of three horizontal lines is clearly seen on the figure's forehead. The simply rendered forms and severe facial features are identical across continents. The overwhelming synchronicity affirms the cultural unity of Pleistocene artifacts from all of the world's inhabited continents. The alignment of these antediluvian sites reveals the complex psychoacoustical means by which the cultural unity was maintained. While regional variations are clearly evident, the common symbolism of tri-frequency entrainment is consistently seen.

Skeletal remains from the stone chambers below Inner Mongolia will provide crucial organic material for accurate dating of the sites, while the overlaying volcanic ash will reveal significant information regarding the antediluvian Sanskrit civilization's demise. The Neolithic Jomon sites of Japan, like the submerged Yonaguni, show strong connections with the Chinese black-skin jadoworks and find continuity in the cultural traditions of the Jomon migrants, as discussed earlier in the context of the seafaring Chinchorro people. The therapeutic tradition of acupressure discovered among the ancient Chinchorro healers has evidently also been preserved in present-day Chinese acupressure traditions originating in the Sanskrit antediluvian mother culture.

Another cultural lineage of Sanskrit knowledge dispersed in the Jomon migrations has been preserved in the oral history of the indigenous Hopi people of the American southwest. Hopi Elders preserve the 12,000 year-old epic story of the long migratory journey their ancestors had made along a great island chain; an actual journey along the Aleutian Islands from Asia that genetic studies have confirmed.¹⁴



5.21. Pictograms from the Hopi sacred stone tablets

The Hopi retelling of a great ancestral migration following the Great Deluge includes details a brilliant *moving star* in which the Great Spirit Maasau'u traveled, guiding their ancestors to the exact location where the Hopi have resided ever since. After arrival at their sacred destination Maasau'u met with the Hopi clans and gave instruction on the sacred lifeplan for human beings as set out by the Creator and a set of stone tablets engraved with mnemonic images of prophetic information provided. These sacred stone tablets have been preserved for millennia by the Hopi wisdom tradition and are today in the protection of Fire Clan Elder Martin Gashweseoma on Third Mesa.¹⁵

The Sanskrit *swastika* symbol for life force, or *asu-asu* is engraved on one of the stone tablets next to a circular human head sign, while the reverse side of the tablet presents a human body standing headless. These images reflect the Hopi concept of people with 'two-hearts' who have deviated from the sacred lifeplan and instead walk through life *with their head cut off from their heart*. The Hopi describe a two-hearted person as someone who listens only to their right side, considered evil because it is clever but lacks conscience. The left side contains the heart and, wise though awkward, predominates in people of 'one-heart'. The swastika symbol for vital energy reflects the acoustic alignment of sacred sites to the 1.45 Hz heartbeat, synchronizing the brain with the heartbeat –*tri-thalamic entrainment*. The sacred lifeplan of being barefoot at sacred sites ensures tri-thalamic brain-function at 1.45 Hz, while those who deviate from sacred ways walk in confusion as dissonant pulsations dominate their pineal, pituitary and hypothalamus functions. Psychoacoustic research confirms ancient Hopi knowledge etched long ago in stone pictograms. Diagrams of two of the sacred Hopi tablets are included here for analysis (5.21).¹⁶ One presents banded twin snakes encircling the sacred plants, animals and human beings –a clear reference to DNA. Another stone plate depicts the DNA serpent with footprints and the ground pressure of sound waves, and a vertical resonant alignment map including *nakwách* signs formed by nested semicircles that symbolize psychoacoustic synchronization between the two brain hemispheres at each aligned site! Also depicted are corn stalks encoding the Sacred Tree discussed earlier, as well as *nonlinear standing wave diagrams* and ghost-like symbols for the radiant cloak of light that vitalizes the human body. The geometric symbols of the Hopi exactly encode the advanced psychoacoustic knowledge of Aztlan –a Sanskrit world culture that developed giant pyramids and extensive subterranean complexes that can still today be used to unify the consciousness of humanity.

References

- ¹ Mejdahl J (1980) 'Further Work on Ceramic Objects from Glozel' *Achaeometry* 22, pp. 197-203
- ² Schildmann K (1999) '*Als Das Raumschiff 'Athena' Die Erde Kippte - Indus-, Burrows-Cave- und Glozel-Texte Entziffert*' CTT-Verlag, Appendix, p. 2
- ³ Ibid, Appendix p. 2
- ⁴ Narby J (1998) '*The Cosmic Serpent: DNA and the Origins of Knowledge*' JP Tarcher, New York
- ⁵ Schildmann, op cit, p. 82
- ⁶ Ibid, p. 82
- ⁷ Ibid, p. 54
- ⁸ Moulton-Howe L (2006) '*New Hampshire's "Mystery Stone"*' Earthfiles: July 29, online · <http://www.earthfiles.com>
- ⁹ May W (2002) 'Ancestors of Our First Americans: A Kentucky Cave Story' *Ancient American* 7, pp. 38-39 · <http://www.burlingtonnews.net/giantskentucky.html>
- ¹⁰ Matheny RT (2007) 'An Analysis of the Padilla Gold Plates' Brigham Young University report, online · <http://byustudies.byu.edu/shop/pdfsrc/19.1Matheny.pdf>
- ¹¹ McCraty R, Atkinson M, Tomasino D (2003) '*Modulation of DNA by Heart-Focused Intention*' Institute of HeartMath, online · http://www.heartmath.org/templates/ihtm/research/research-intuition/Modulation_of_DNA.pdf
- ¹² Xu J (2001) 'The Enigmatic Art of Sanxingdui: Bronze Trees and Masks Evoke the Spirit Worlds of a Lost Civilization in China' *Natural History*, online http://findarticles.com/p/articles/mi_m1134/is_9_110/ai_80061819/pg_2
- ¹³ Tong L (2007) '*Astonishing Discovery of Ancient Chinese Civilization*' Antara News/PRNewswire-AsiaNet, online · <http://www.antara.co.id/en/arc/2007/8/13/astonishing-discovery-of-ancient-chinese-civilization/>
- ¹⁴ Hong-Chuan L, Toshinobu F, Hong L, Shinji Y, Shuro S, Cartier L, Nunez L, Munoz I, Satoshi H, Kazuo T (1999) 'The Presence of Ancient Human T-cell Lymphotropic Virus Type I Provirus DNA in an Andean Mummy' *Nature Medicine* 5, pp. 1428-1432
- ¹⁵ -- (2006) '*Grandfather Martin Gashweseoma: Traditional Hopi Elder and Guardian of the Sacred Stone Tablets of the Fire Clan*' TheDreamMasters.org, online · <http://www.thedreammasters.org/hopi/martingashweseoma.php>
- ¹⁶ Waters F (1963) '*The Book of the Hopi*' Viking Press



6

Ultraviolet Caves of La Maná

Ultraviolet Caves of La Maná

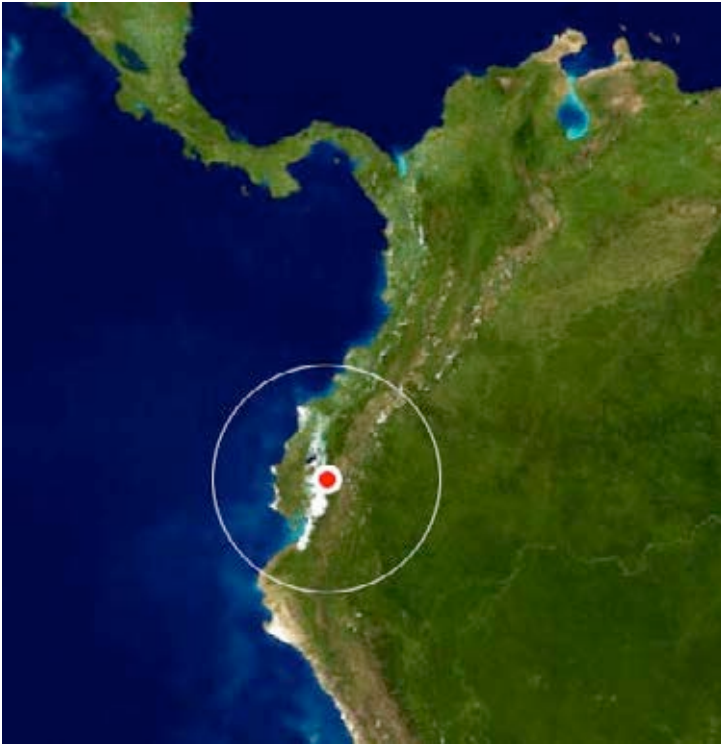

6.1. Mist-shrouded mountains of La Maná, Ecuador

Archaeological finds from La Maná, Ecuador include fascinating examples of high-tech kundalini instruments used to focus light, sound and electricity into the human body. Stone masterpieces display the ultraviolet fluorescence of calcite crystal, found in the pineal gland: the Sanskrit 'third-eye'. The largest worked stone is a map engraved with the continents of the glaciated Neolithic Earth prior to the Great Deluge that changed the face of our entire planet. In 1984 this large cache of over 300 artifacts was discovered by a group of gold prospectors led by engineer Dr. Elias Sotomayor, in a tunnel 30' below ground in the jungle-covered mountains of La Maná, Ecuador (6.1). Accurate dating of the artifacts eludes even the latest methods, as the thermoluminescence technique would be unreliable due to years of exposure to sunlight since their discovery. Archaic Sanskrit script is found on one stone piece, while the entire collection details the kundalini process in complex geometric forms, inlaid with quantum fractal maps of standing waves.

The engraved script is consistent with the logographic form of Sanskrit, the mother language from which the Mayan, Sumerian and Egyptian glyphs descended. The geometric analysis given herein suggests that the La Maná artifacts encode fractal information regarding the resonant properties of calcite mineral, informing the design function of the Orion pyramids at Giza. The La Maná site (0.95°S 79.18°W) is 7,470 miles from Giza –a distance that is *precisely* 30.0% of the Earth's mean circumference of 24,892 miles. These finds defy categorization among any known culture from South America, being very much older and exhibiting iconography consistent with Sanskrit traditions once thought to be foreign to the Andean region. The place name itself is an ancient one, likely a remnant of the prior Sanskrit inhabitants for whom the word *mana* meant 'mind' or 'mental body'. The significance of this name may become clear as the artifacts reveal their encoded psychoacoustic geometry. Most amazing are the representations of the Great Pyramid at Giza, the cobra (a snake known to exist only in Southeast Asia) and an engraved global map showing the present continents of the world and other landmasses now submerged.

These stone and ceramic masterpieces present advanced craftsmanship, including magnetic effects and inlaid mortars that fluoresce under ultraviolet light. The artifacts defy any simple explanation, revealing the technological capabilities of ancient man to have been far in advance of that used by 'industrial' man today. The group of over 300 objects remains in Ecuador, in the private collection of German Villamar, who received them as a gift from Dr. Sotomayor some years after their discovery. All of the photographs of the Villamar collection were produced by Rafael Cuesta in 2002 and given to this author by German himself during my two-month visit to the La Maná archaeological site beginning in December of 2006. My initial visit to the Sanskrit sacred mountain took place in February of 2004, when I was able to meet Dr. Sotomayor and discuss his finds and witness demonstrations of the fluorescence and magnetic effects observed among the most intriguing pieces in the collection. My analysis of these enigmatic artifacts will focus on the profound implications of the fractal mathematics represented by their forms and inlaid patterns. The genius of the Sanskrit mother-culture that flourished throughout the Neolithic world on every inhabited continent is witnessed in these masterpieces of antediluvian civilization.

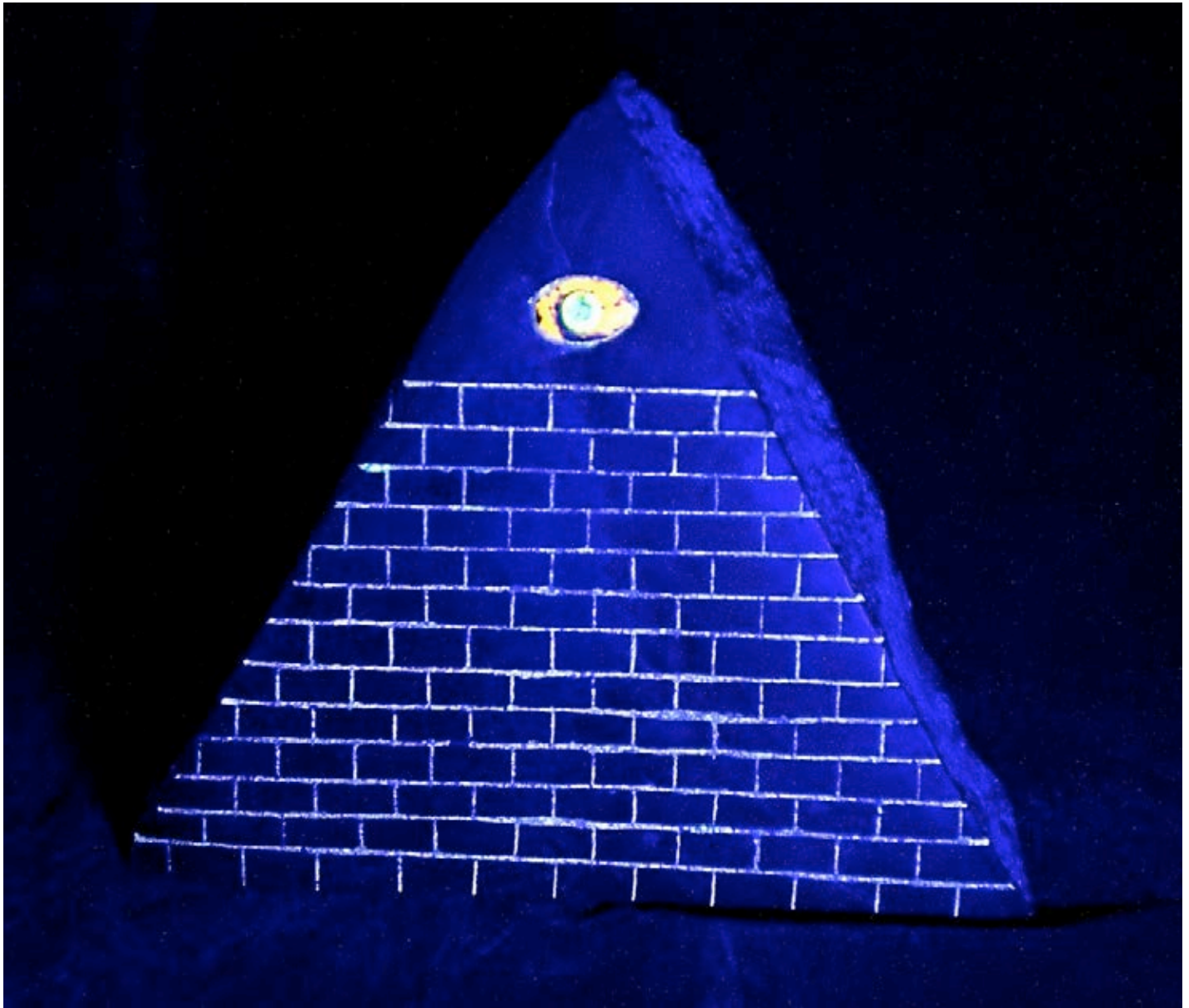

6.2. Third-Eye Pyramid presenting prime numbers in 13 stone layers, 3 sides and 1 eye, seen fluorescing under UV light

Perhaps the most strikingly familiar imagery to have been reproduced among the La Maná artifacts is a triangular stone that has been finely polished and inlaid –the Third-Eye Pyramid. This remarkable stonework is immediately recognizable as a representation of the Great Pyramid of Giza, 7,470 miles away; the only one of the world’s many pyramids that presents a pure geometry of four planar faces, lacking the stepped façades common to most Mesoamerican pyramids. Interestingly, this South American artifact records the ‘third-eye’ symbol for the psychoacoustic attunement of the pineal gland.

Ultraviolet fluorescence effects are a well-known quality of calcite and other minerals found in natural abundance. Mineral calcite has been mixed as a mortar and inlaid into the lines incised upon the stoneworks’ faces. Visible light is emitted upon exposure to longwave ultraviolet light (365 nanometer wavelengths) when electrons fall back to their initial or ground states, causing some of the exciting energy to be lost as heat, resulting in a shift in the wavelength of the energy to lower energy (longer wavelength) visible light. Many minerals possess this quality, also observed upon exposure to shortwave ultraviolet light (255 nanometer wavelengths). Scheelite can produce a bluish-white and willemite a bright green under shortwave. Fluorite emits a blue, scapolite an orange-yellow and hyalite and autunite produce a yellow-green under longwave ultraviolet.



6.3. Bottom face of the Third-Eye Pyramid bears an inscription in logographic Sanskrit and the Orion's belt in gold inlays

The fluorescence spectra of certain minerals can be used as a rough indicator of the locality of the deposit in which it was formed, but is by no means reliable enough to define the origin of the materials used in creating the artifacts of La Maná. Various admixtures have apparently been used to specify the spectrum of light emitted by the various colored mortars used to achieve the inlaid designs. Manganese is likely among these mineral additives to the calcite mixture, though specific color-producing combinations have not yet been determined. Calcite may emit a large range of colors under longwave UV light including white, blue, red, orange, yellow and green, and the ancient artists at La Maná used the entire fluorescent palette in their geometric designs. This fluorescence effect has been described as quantum scattering, and has also been employed in the creation of brilliant pigments by the Mayan ceramicists of the Yucatan peninsula. The clays used by the Maya contained nanoparticles of iron and manganese that, when boiled with indigo, produces Maya blue.¹ The metallic nanoparticles scatter light in a nonlinear, quantum fashion as the atoms in the metals vibrate near the wavelength of the re-emitted blue light.² This resonance amplifies the reflected light, as it does in the fluorescent inlays from La Maná. The Maya apparently inherited many quantum techniques from the preceding Sanskrit mother culture.

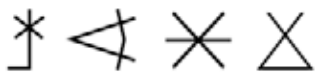

u mahā-ta upama

oh greatness, the highest

According to Dr. Kurt Schildmann's logographic Sanskrit decipherment³ the inscription on the base of the Third-Eye Pyramid stone (6.3) reads *u mahā-ta upama* meaning "oh greatness, the highest." This Archaic Sanskrit text is inscribed into only one of the La Maná artifacts, yet the information conveyed by the geometric patterns repeated throughout the entire group far exceeds the capacity of words, suggesting this culture defined itself by the four-dimensional mathematics reflecting the unity of universal consciousness.



6.4. Kundalini Cobra lingam (front, back) referencing 33 horizontal lines, 7 connected dots, 2 nostrils and 1 dot

The structure of prime numbers has been of deep interest to pure mathematics. The essential question has remained unanswered: whether or not prime numbers appear randomly in the sequence of whole numbers. While prime numbers generally display a six-cycle of prime pairs (discussed later in detail), there appears to be no repeating pattern. Geometric florescent inlaid patterning presented in the La Maná stoneworks repeatedly references prime numbers 1, 2, 3, 7, 11 and 13. The impressive Third-Eye Pyramid displays 3 sides, 13 horizontal divisions or steps, and 1 eye symbol (3.7). The single engraved and inlaid florescent eye is a Sanskrit spiritual symbolism for the psychic sight of the pineal gland: *the third-eye*. The reverse side of the triangular artifact bears a gold-plated inscription of the Orion's belt constellation, with 5 stars instead of 3, as seen in the design of the Orion pyramids.

The fluorescence effect of the stoneworks begs the obvious question: *how was ultraviolet light being produced* in the caves to reveal the magnificent glowing of the calcite inlays? The answer has been revealed by scientific analyses of sacred water that flows in abundance from ancient springs along the mountainside. The special properties of La Maná's celestial water (identified in Chapter 7) are perfectly suited to generating ultraviolet and infrared light *by the formation of hydrino plasma* (3.15, page 20).



6.5. Kundalini Cobra fluorescing under UV (left) and another coiled Kundalini Serpent with fluorescent inlaid dots (right)

The Sanskrit word *naga* means ‘serpent’, while *kundalini* means ‘snake’, and is used as a spiritual metaphor for a coiled cord of energy residing in the human body, symbolically embodied as the hooded cobra native to sub-Himalayan Asia. Kundalini creative energy can be stimulated to elevate consciousness through the natural *chakra* system (Sanskrit ‘wheel’), an alignment of seven rotating vibratory centers of the body. Chakra energetic levels correspond to light and sound spectra, each with a distinct frequency and color, the lowest frequency basal or root chakra being red, and continuing in ascending order through orange, yellow, green, blue, and indigo to the violet crown chakra, highest in frequency. This string of energy wheels can be thought of as the foci through which human consciousness escalates when the proper resonant conditions are engendered in the body. The *lingam* is a phallic instrument used anally during meditation to release the coils of the kundalini serpent, presently dormant in humans, into upward movement along the spinal cord through all 7 chakras to blossom at the crown. This stimulation of the energetic flow is understood to promote expanded awareness, having powerful effects on consciousness when used in a resonating temple setting. Once again, the improper use of the lingam (outside of a resonant environment) renders it ineffective.

These Sanskrit bioenergetics concepts are holistically encapsulated in the inlaid patterns of a La Maná stone, the Kundalini Cobra lingam (6.4, 6.5, left), geometrically describing this movement of energy from the dotted center at the end of the phallus, along 33 ventral stripes through the 7 chakras depicted on either side of the cobra’s hood. Prime numbers are depicted in fluorescent inlays, 1 dot at the head of the phallus, 2 dots for the eyes and 2 for the nostrils and 7 connected dots at each side of the cobra’s hood. The 33 horizontal inlaid bands on the cobra’s ventral side represent kundalini energy movement up the spinal cord’s 33 vertebrae. The number 7 is also reflected by the nostril and mouth together to form the Sanskrit and Mayan numeral 𑌗. The jade Kundalini Serpent also displays inlaid dot patterns (6.5, right).

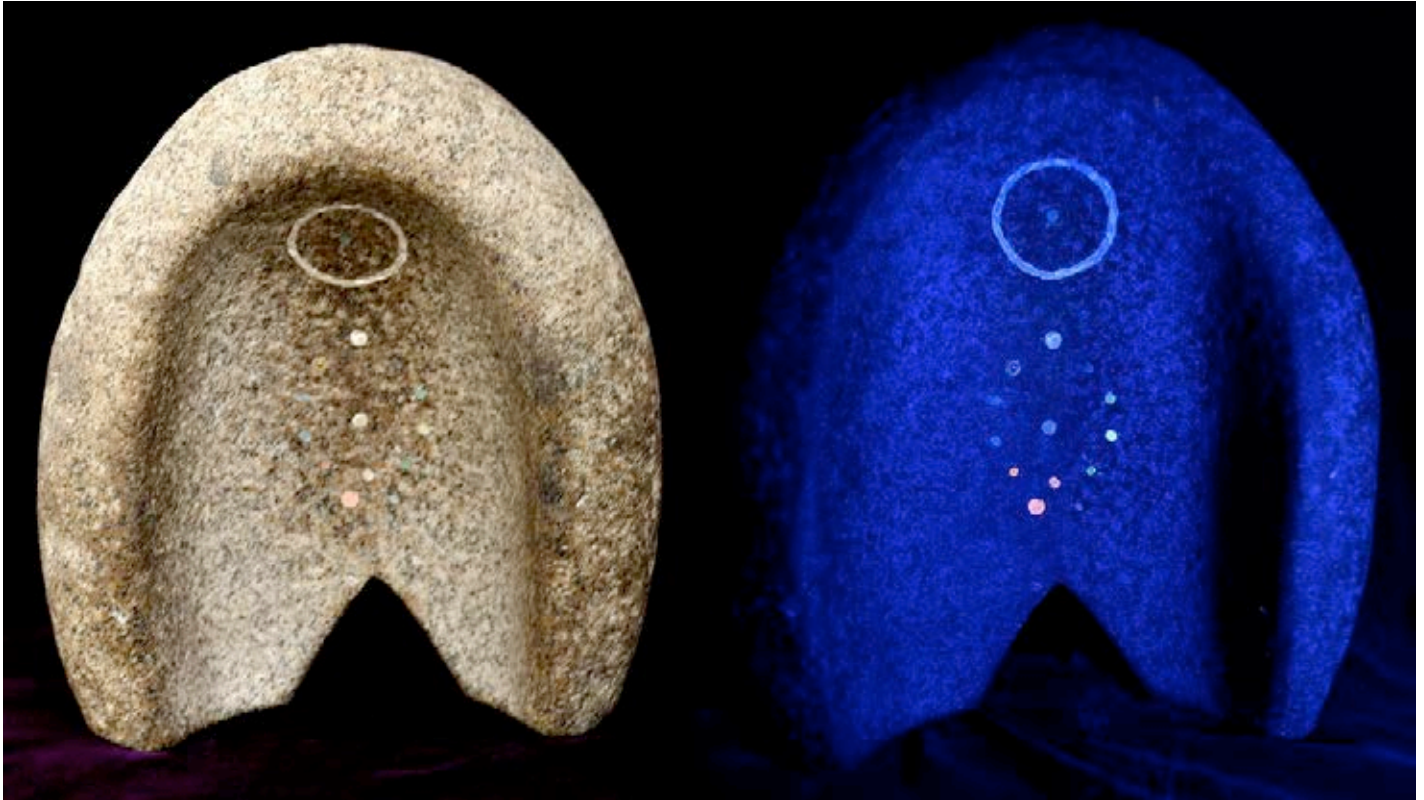

6.6. Psychoacoustic granite head cradle with an encircled dot at the crown chakra and multicolored dots at the occipital

One large inlaid granite stone is yet another very unusual artifact discovered among the finds at La Maná, fluorescing under ultraviolet light like so many others (6.6). While it appears, at first glance, to be a food-grinding bowl, a more unexpected purpose informs its design. Were it not for the delicately inlaid calcite patterns, forming a solid circle enclosing a central point and a series of thirteen dots arranged in another circular formation below, this object could find a practical use as a grinding mortar. The inlays, however, deny this utilitarian function, as the user would inevitably destroy the maker's beautiful work. Instead, the quartz composition, size, form and v-shaped bottom notch prove the psychoacoustic purpose of this masterpiece –used to cradle the back of the human head while focusing acoustic energy into the brain. The v-shaped notch fits over the nape of the neck while the weight of the stone rests on the user's shoulders. The engraved circle sits atop the head at the crown chakra and the multicolored dots encircle the occipital region of the skull where acoustic waves are focused by its concave form.

The psychoacoustic effects of this lithic head cradle can only be achieved when used in a resonant environment like the sandstone subterranean chambers where it was discovered, along with the rest of this Ecuadorian collection of more than 300 Atlantean artifacts. The quartz crystals of the granite stone transduce ambient acoustic energy efficiently into the center of the user's brain, artificially stimulating the pineal gland into resonance with the hypothalamus and the pituitary gland to synchronize mental function. As identified earlier in all regions of the world, this enhanced neurological state of tri-thalamic entrainment is a psychoacoustic process inducing synesthesia, as symbolized by the sacred *third-eye*, found throughout Sanskrit culture and the artifacts collected at La Maná, Ecuador.

The ultraviolet fluorescence of the mineral calcite inlays is another profound symbolism for the special resonant properties that can be imbued in the human body itself by the use of these sacred Sanskrit instruments. The very same process that occurs in calcite to allow its fluorescence –the emission of light by inducing electrons to move closer to their atomic nuclei– *can also be induced in hydrogen*, releasing vast amounts of latent energy. The penetrating knowledge of our global Sanskrit mother culture is hidden in the rocks below us, in the microcrystals in our bones, in our heads, and in the water of our bodies. The La Maná collection is a powerful archive revealing the resonant DNA process of inducing synesthesia.



6.7. Two suited, stargazing figures on a stone constellation map showing Orion, the Pleiades and other constellations

The wisdom recorded in the hundreds of items from Ecuadorian tunnels extends to a detailed understanding of not only the human body and our resonant Earth, but also beyond –to the stars. A pair of constellation maps was also rendered in finely polished stone –a dark jade plate and a large jade cup. Two stone figurines were found on the stone plate that is inlaid with complex dot formations forming several constellations that glow under ultraviolet light like star alignments in the night sky (6.7). The constellations presented on the base do not exactly conform to current observations, suggesting their great antiquity; yet can still be easily identified as a representation of the region of the night sky around Orion, the hunter. Red stars, like Betelgeuse (the right shoulder of Orion), are inlaid with calcite combinations that glow red under ultraviolet light. Also depicted are the lone star Aldebaran, the Pleiades or Seven Sisters, and Castor and Pollux of the Gemini twins and Procion. The base is a symbolic terrestrial reflection of the night sky to which the two standing figures are transfixed in an upward gaze.

The figures are clad in bulky suits, robot-like, leaning back to gaze at the stars above, their wide inlaid oval eyes and outfits fluorescing with the dotted constellations under ultraviolet rays. These two enigmatic figures gaze silently into the same region of Orion's belt repeatedly mirrored in psychoacoustic pyramid architecture worldwide. Although their boxy suits are reminiscent of space suits, they may depict special equipment involved in the bioelectrical processes applied to the human body.



6.8. Largest of 13 stone drinking cups, with twelve fluorescent radial points at the base and an Orion star map above

A set of 13 stone cups with ultraviolet fluorescent inlays presents further prime number references. Rendered in jade, the cups' perfected geometry confirms that advanced lathe techniques were used to rotate the stone while being shaped. One of the cups is oversized (6.8) and inlaid with a pattern of dots representing the same group of constellations represented on the stargazers' map (6.7). The large stone cup is also inlaid with twelve fluorescent blue dots around its stem, another larger set of twelve orange dots around its base and around the bottom of the interior of the cup.

Twelve small drinking cups (6.9) accompany the larger thirteenth cup. The total liquid content of the smaller cups exactly fills the volume of the larger cup. Each of the twelve smaller cups bears an inlaid dot inside the cup and a numeral on the outside. Numeration on the cups, from one to twelve, plus the large 13th, reflects the zodiac and calendar calculations of the cycles of Earth and Ages of human civilization. The La Maná numerals resemble those of the Mayan culture whose complex astronomical calculations are preserved in an astounding timekeeping system that employs Fibonacci proportions to tracking cosmic rhythms. The crystalline composition of these jade drinking vessels allows the sacred crystalline waters that flow from the same resonant Ecuadorian sacred site to transfer the resonance of the sacred mountain to the body of the kundalini initiate. The numerals found these twelve smaller cups are comparable to the numerals of the more recent Maya civilization, suggesting a direct link between the Sanskrit pyramid traditions of La Maná and the penetrating wisdom of the Maya that survives today:

La Maná	•	∴	∵	∶∶	—	⋮	⋮	⋮	⋮	⋮		•	∴
Mayan	•	••	•••	••••	—	⋮	⋮	⋮	⋮	⋮	=	⋮	⋮



6.8. Nine of the group of twelve small lath-turned jade drinking cups, presenting the Archaic Sanskrit numerals four through twelve in sequence

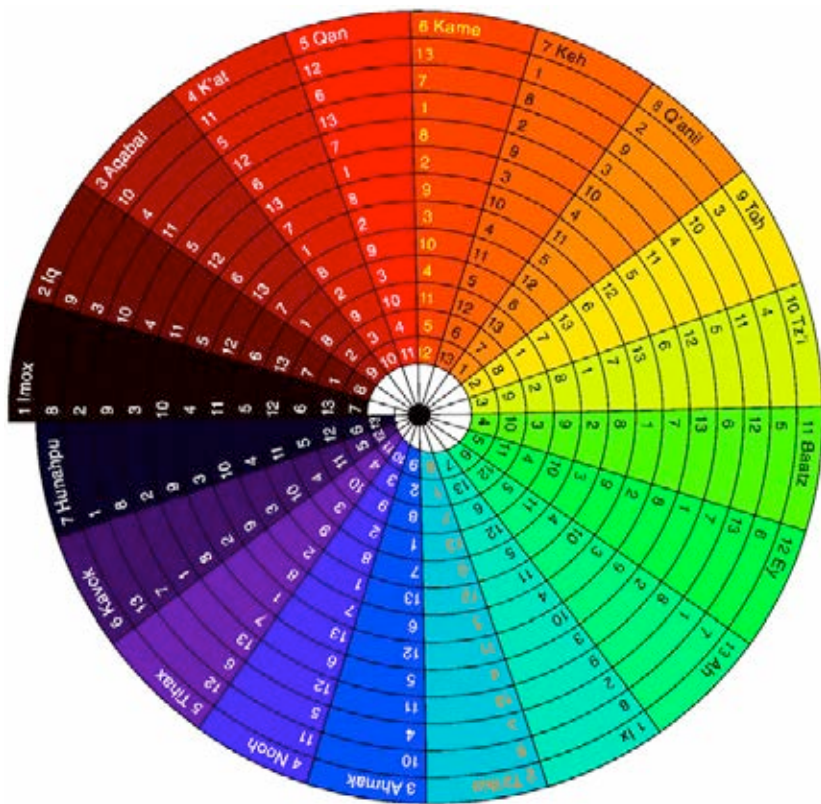

6.10. Spectral spiral of the Mayan cosmic Tzolk'in calendar

It is clear that the astronomy, numerals and scripts of Egypt, Sumer and the Maya were inherited from a far older civilization. The Mayan culture speaks of its ancestry as an advanced civilization of white-skinned people, a complexion that may have resulted from subterranean living –the realm in which the highly technical and complex La Maná artifacts were discovered. The beginning of the Mayan cosmic Baktun calendar predates the Mayan culture itself by millennia, a fact that suggests the continuity of the knowledge of cosmic cycles from a more ancient advanced source. The complex sacred teachings have been passed on meticulously by Time Keepers like Gerardo Barrios Kaanek⁴ who began his spiritual journey at the age of 13 with a Maya Ajq'ij, a master of knowledge. Kaanek relates that we are living in the times of the prophecies of the Ox Lahji Baktun. This, the Mayan cosmic calendar, spans 5,125 years, ending on December 21, 2012, of the Gregorian calendar system.

The closing of this calendar cycle is prophesied to be a period of great destruction for all humanity, a cataclysmic shift involving the whole solar system. The planetary calendar is called the Ha'ab. There are four prophetic calendars, one of which foretold a period of 9 times 52 years, known as Belajeb Bolamtiku or *'the nine periods of darkness'*. This calendar relates to the foreseen darkness brought by the Spaniards in the form of disease, guns and Catholicism. Its duration was 468 years having begun on the exact day and hour that Hernando Cortez arrived in Veracruz, Mexico. The Belajeb Bolamtiku cycle has already elapsed, and has been followed by a nine-year cycle of gestation that ended in the Gregorian calendar year 2001. The most important of the Mayan calendars are the Tzolk'in (6.10) and the Tzolk'ij. The Tzolk'in is for the observation of time, and of the different energies that interrelate with the human being, having 260-day cycles reflecting *the human gestation cycle*. Being just short of a 9-month period of the Gregorian calendar, the Tzolk'in cycle is nearly 5/7 of the Solar Year ($260 = 5 \times 52 = 13 \times 20$ and $364 = 7 \times 52 = 13 \times 28$). Fibonacci numbers and relationships⁵ have been found to underlie the interaction of Tzolk'in cycles with the other calendars,⁶ being based on the prime numbers 5, 7, 13, and the sum of the first six Fibonacci numbers, 20. The observance of interpenetrating temporal rhythms by the Maya is linked with their conception of *k'ulthanlilni* and *chac'a*, corresponding directly to the Sanskrit concepts of kundalini energy and chakra centers. Modernity's shallow linear conception of time is contrasted sharply by the Mayan conception of cyclical time and the primacy of the circle. Indigenous wisdom widely echoes this penetrating truth, as in the words of Oglala Sioux Elder Black Elk (b. 1863):

You have noticed that everything an Indian does is in a circle, and that is because the Power of the World always works in circles, and everything tries to be round. In the old days when we were a strong and happy people, all our power came to us from the sacred hoop of the nation, and so long as the hoop was unbroken, the people flourished. The flowering tree was the living center of the hoop, and the circle of the four quarters nourished it... Everything the Power of the World does is done in a circle.⁷

The Hopi of the American southwest referred to their sacred landscape as 'the four corners,' while the Andean Inca occupied Tawantinsuyu, 'land of the four quarters'. These potent descriptions of the Prime Cross structure is also very accurately described by several other artifacts found in the chambers below La Maná, especially a set of finely polished stone discs inlaid with circular designs that also describe the sacred hoop of the nation, both in its 'unbroken' state and in its current 'broken' state of misalignment.

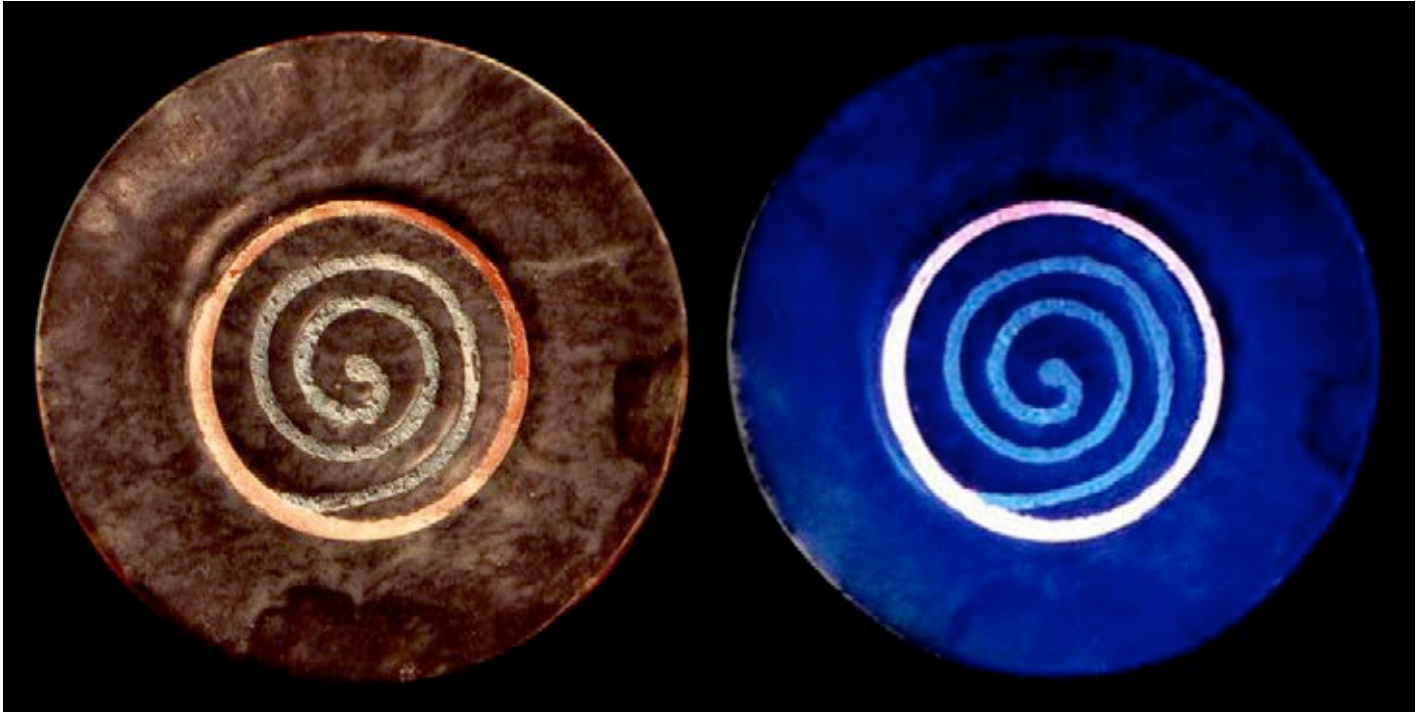

6.11. Inlaid Spiral Mandala Disc fluorescing under longwave UV light creates a hypnotic effect when rotated slowly

A set of small elaborately inlaid stone discs was also recovered from the tunnels near La Maná. Their strictly geometric design is based on the circle, or *mandala* in Sanskrit, a sacred symbol for the principle of *unity*. The ancient Sanskrit mandala principle has been passed on to myriad indigenous cultures around the world and appears in sacred artwork across the world, usually inset by a square to form a symbol of octagonal symmetry. The circle expresses the concept of the cyclical motion of nature and reveals the error of linear perspectives. The straight line is an abstraction of the human mind, and does not exist in the universe. In reality, space and time are curved and inevitably turn back onto themselves to form a circle. *All that exists is composed of circles*. By this we can comprehend that time has no beginning and no end, but instead is a continuum. Sanskrit science describes time and space as constantly and rapidly blinking in and out of existence –the material universe is but one half of the time cycle perceived as physical reality, while the antimatter universe, Chittakash, perpetually reflects unity.

The Spiral Mandala Disc stone (6.11) is inlaid with a spiral pattern that describes gravity by marking an orbital path to the gravitic center of the circle, representing *the path inward to the point of stillness*. The contracting spiral path is rendered in a blue florescent inlay, while the outer circle is a reddish-orange in daylight and a brilliant white under ultraviolet. The spiral design is today culturally symbolic of inward journey through meditation and used to hypnotic effect in perpetual rotation, inducing the hypnogogic state to access the subconscious. This disc exhibits a region of magnetic zero at its center that has been tested consistently, causing any magnet hung like a pendulum over the center of the disc to rotate over the inlaid surface in the very pattern of incised circle. The stone disc was most likely magnetized by exposure to strong magnetic fields, like the conditions generated by resonating psychoacoustic architecture as described earlier. This circular stone disc astonishingly presents ancient wisdom concerning the relationship between magnetism and gravity as planetary forces that can be focused.

A pair of palm-sized octagonal stone plates found together may have been placed on each palm during meditation (6.12). One octagonal stone is inlaid with 7 prime concentric circles, and the other with both concentric and offset circles inlaid. The stone with the concentric set contains seven light-colored circles, another prime number reference. This pattern of concentric circles is a quantum map expressing the quadratic function $[z_{n+1} = z_n^2]$ encoding the standing wave resonance pattern that is observed in the light scattering of the electron and the crystallography of calcite mineral used in the mortar (3.4)!

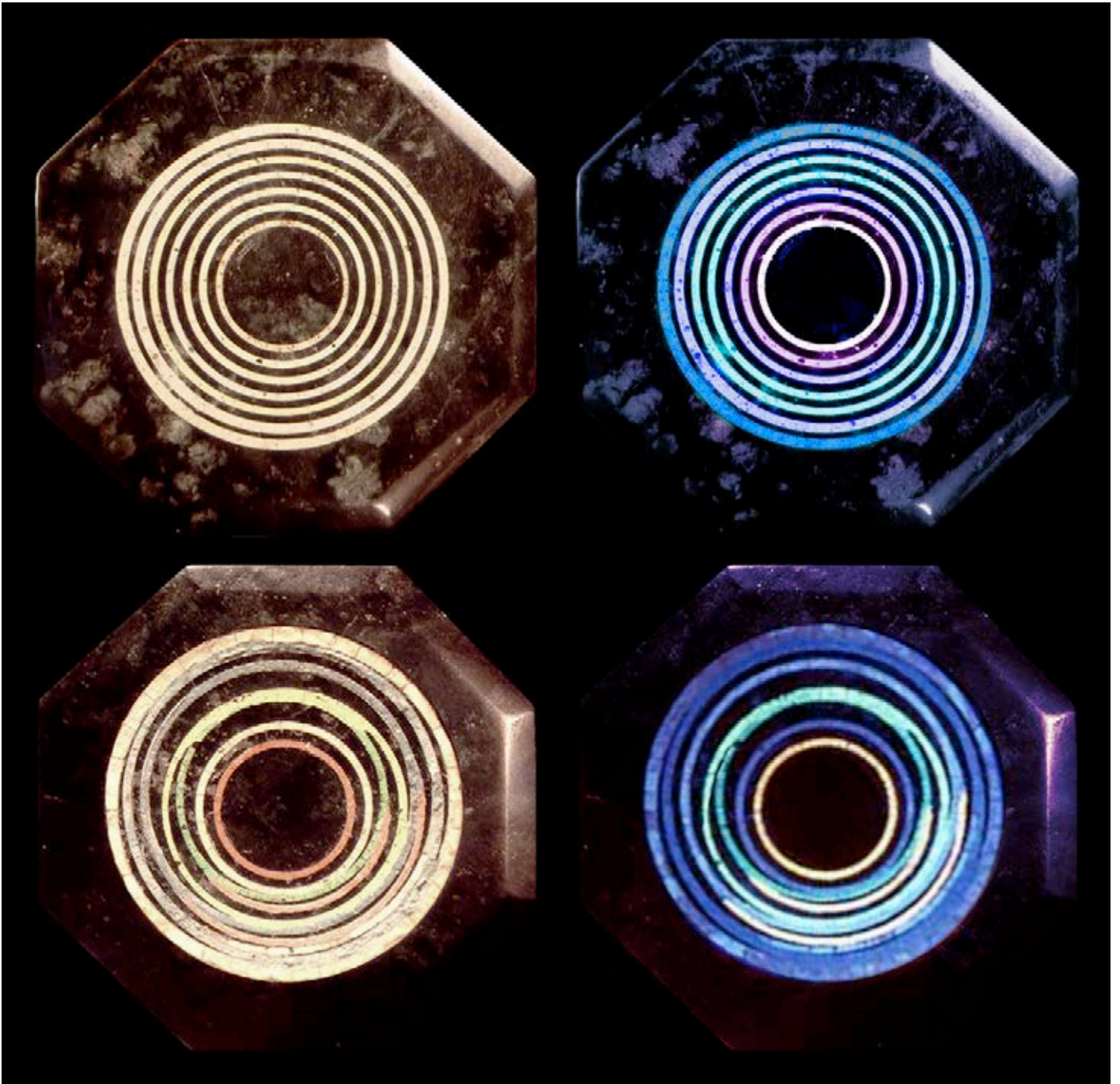

6.12. Two octagonal stone plates –one with 7 concentric multicolored circles and another with slightly offset circles

The fundamental importance of this pair of quantum fractals cannot be understated. The designs form a complete visual explanation of the fluorescence phenomena displayed by the calcite mineral of its inlays, which is also the main constituent of biomineralizations in the human pineal gland and the limestone blocks of the world's pyramids. *These resonance mandalas present a pattern of refraction observed at all scales of the cosmos*, in the light scattering of electrons, calcite crystals and the infrasound patterns focused by planetary resonance (3.5, 3.6). The paired fluorescent stones were apparently designed to convey an offsetting shift in the planetary resonance structure of infrasound nonlinear standing waves. The hypothesis of Magnetic Resonance posits that the magnetic North pole is the magnetic center from which emanate the frequencies of Earth's resonant hum, presenting an interesting possibility –perhaps the variation between the designs of the two octagonal discs can be seen as describing an aberration in the field of planetary resonance caused by a shift in Earth's magnetic orientation caused by the Deluge.

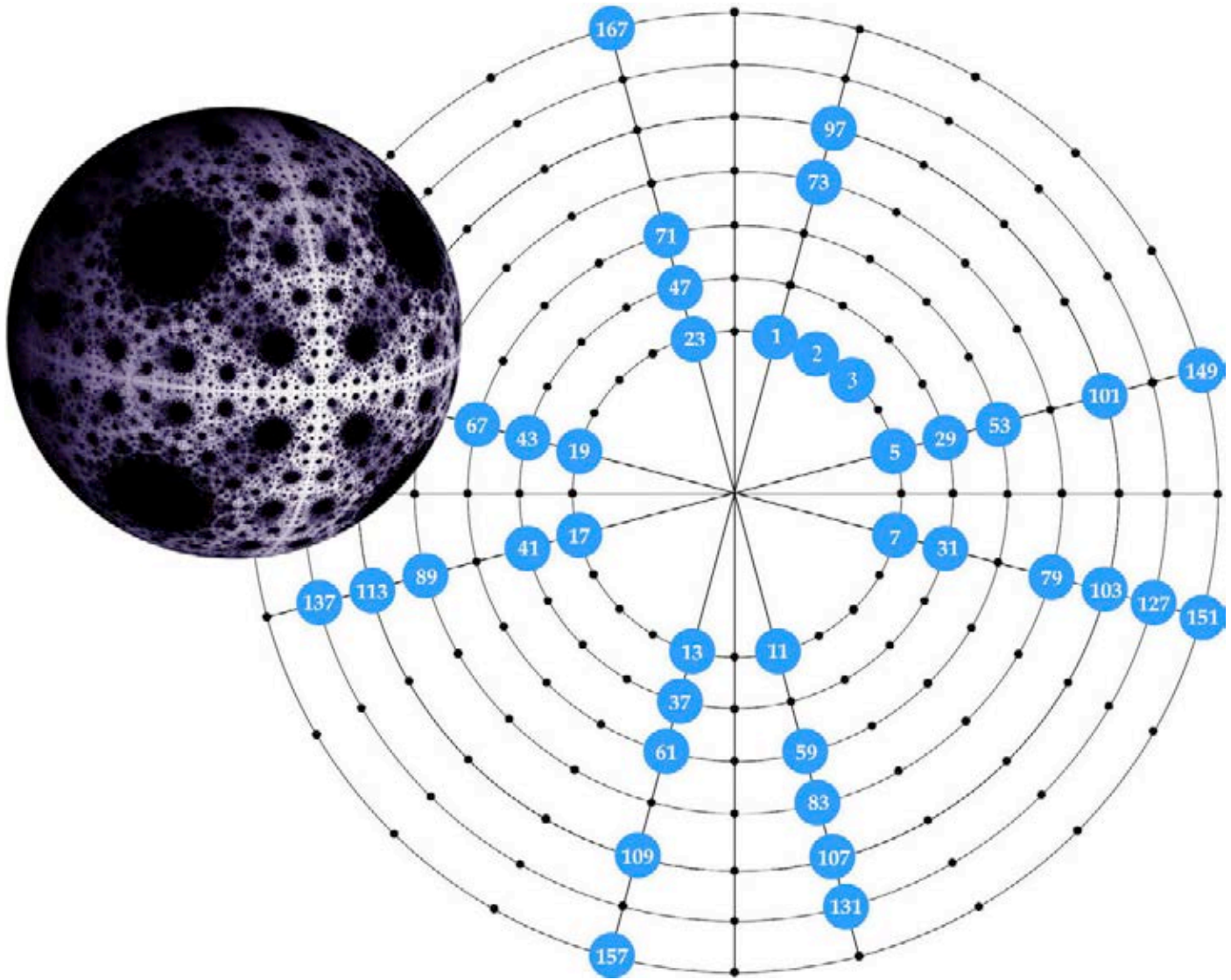

6.13. The Prime Number Cross shows a strong synchronicity with Jadczyk's Octagonal Quantum Iterated Function

The current location of the magnetic North pole fluctuates more than eleven degrees off the geographic North Pole, as has been the general case for the last 12,000 years of Holocene global warm trends. The preceding Pleistocene glacial age was abruptly ended by a catastrophic event that likely involved the offsetting of the magnetic poles to their current fluctuating alignment, slowly wandering back toward the axis of rotation. The octagonal stone disc with offset multicolored circles may be symbolic of the current misalignment of the magnetic pole and the resulting asymmetry in the standing wave patterns of Earth resonance. The prior high-resonance alignment is presented by the La Maná artists as perfectly concentric circles in the symmetric alignment of resonance (seven is prime). This octagonal cross was once called the Celtic Cross, the Rose Cross by the Copts, and is referred to by Native American tribes as that has four-quartered hoop of the nation—a complex structure referenced by prime number geometries encoded in myriad artifacts from La Maná. In their collective presentation of the sacred order of primes, the deeper holographic application of the information comes into focus. Prime numbers are defined as numbers that are only divisible by 1 (and by themselves). The organization of prime numbers within the series of whole numbers has been a mystery to modern mathematics until the work of Peter Plichta, a Düsseldorf chemist. In 1997 he put forth his theory of the structure of prime numbers being based on a cycle of 6, a product of the indivisible numbers 1, 2, and 3. While not the first mathematician to recognize the six-cycle of the sequence of primes, his work has extended this understanding to the role of prime numbers in all of the structures underlying the physical universe:

Apart from the numbers 2 and 3, all prime numbers occur in a cycle of 6. $6n \pm 1$ for $n = 1, 2, 3, 4, \dots$
For combination reasons this cycle produces a series of prime-number twins, [5, 7], [11, 13], [17, 19], 23, ...
although with the number 25 we inevitably obtain the first square of a prime number from the function $6n \pm 1$
(the next composite number is the product of $5 \times 7 = 35$), which is not prime. The reason why the number six
plays such an elementary role in the complex of whole numbers is that the numbers 1, 2 and 3 are indivisible.
As a result, the complete number 6 must be surrounded by the expression: $6 - 1 = 5$ and $6 + 1 = 7\dots$ ⁸

Plichta's search for the significance of prime numbers extends to the essential structures of nuclear chemistry and biochemistry, specifically that of atoms and the periodic table of elements, as well as the amino acids and the DNA helix. The six-cycle structure of prime numbers can be visualized as a symmetric octagonal cross, with seven concentric circles divided into 24 radial points (6.13). Being a universal constant "the 'Prime Number Cross' is not a human invention. It is in fact a model of the construction plan with which infinity was made finite in the structure of the atoms."⁹ This same model has also been derived by the quantum mechanical algorithms of theoretical physicist Arkadiusz Jadczyk in a more complex rendering known as the Octagonal Quantum Iterated Function (QIF) (6.13, inset).¹⁰ The Prime Number Cross and the Octagonal QIF are synchronous patterns reflecting the structure of resonance inherent to atomic, molecular, planetary, solar and galactic structures.

The prime number 3 is inherent to all atomic nuclei, consisting of 3 stable particles, protons, neutrons and electrons, and in the basic components of DNA: phosphoric acid, sugar and base. The 4 different bases of DNA (adenine, thymine, guanine and cytosine) occur in pairs. The 20 amino acids can be divided into two groups: the first consisting of glycine which does not refract polarized light, and the remaining 19 being stereochemically left-oriented. The periodic table of elements also presents many prime number synchronicities relating to their stability, beginning with number 1 hydrogen, the essential ingredient for life. There are no stable elements beyond number 83 bismuth, and among this group there are 3 unstable elements, number 43 technetium, number 61 promethium and number 75 rhenium. The significance of prime numbers in the essential structure of all matter and life extends beyond the limits of human perception into 4-dimensional space-time:

A concept of 4-dimensional space has been used by scientists since Einstein... The discovery and visualization of the four dimensions of space is a momentous advance, not only for scientists and thinkers but for all of mankind. The geometry of this newly discovered four-dimensional space is in the form of a cross and originates in the mathematics of Leonhard Euler. It has now been named the Prime Number Cross."¹¹

Plichta very frankly acknowledges that this fundamental natural structure was expressed by the architects of the Giza pyramids in the quadrupolar geometry of the pyramids, easily observed from above (3.1). The hypothesis given herein describes the Prime Number Cross as the structure of consciousness by which *the finite is made infinite* through the interaction of ULF acoustic waves. The human mind can be tuned by acoustic waves within the alpha, theta and delta ranges to engage regions of the subconscious that are not ordinarily experienced in beta states. The enhanced acoustic environment of sacred architecture is achieved by tuning the dimensions of resonant chambers of quartz or calcite stones. The low frequency resonance of the Earth can be transduced by crystalline structures, due to their refractive properties that form standing sound waves in the four-dimensional structure [$z_{n+1} = z_n^2$]. The resonant mineral qualities allow a molecular deformation to occur called the *piezoelectric effect*. This effect involves the conversion of mechanical (vibratory) energy to an electrical field in various materials including ceramics, limestone, granite, sandstone and even plastics. For a piezoelectric crystal, if mechanical stresses are applied on two opposite faces, corresponding electrical charges appear on some other pair of faces. Vibratory energy in a waveform entering the piezoelectric crystals is transduced into an electric field created by the vibration of the whole piezoelectric mass. This mechanical force applied to the piezoelectric material causes a molecular structural deformation resulting in a rapid continual reversal of electrical polarity, a quality referred to as *dielectric*.

Water, the main constituent of the human body and the Earth's oceans, is also a dielectric substance. Bone is formed by calcium. Calcite, or calcium carbonate (CaCO_3), is one of the most common piezoelectric minerals in the lithosphere –the main constituent of limestone, a sedimentary rock resulting



6.14. Coptic Cross at the Temple of Philae (left); and on a Coptic ceramic bowl with double sine waves encircling

from ocean deposition processes. CaCO_3 is a tetrahedral molecule while CaCO_4 is octahedral in structure. More complex forms can display an octahedral or rhombohedral crystalline structure. Calcite is often fluorescent, a small amount of manganese is enough to make it glow red under ultraviolet light. An acoustic wave's energy is dispersed into the crystalline structure along its angular paths, reflecting within the crystal's many parallel faces. Traveling waves propagate through the atmosphere because of the variation in temperature with altitude, known as the temperature gradient. As an acoustic wave propagates through Earth's atmosphere the upper portion of the wave is cooled more than the lower portion causing it to sink, thus curving the wave downward. Conversely, as the wave approaches the hot radiating Earth the lower portion of the wave is heated more than the upper portion causing the wave to curve upward. Ordered piezoelectric structures exhibit dielectric polarity reversals that evenly and regularly distribute the electrons within the material. This state in resonating limestone structures produces an even temperature distribution gradient within the material, collapsing the waveform of energy as it moves through the crystalline lattice into a straight angular path. The homogenous molecular lattice structure absorbs all wavelengths of electromagnetic energy (light and sound) into internally reflected standing waves that build up within the crystal lattice.

Quartz crystal –silicon dioxide (SiO_2)– is another crystal that exhibits piezoelectric properties. Granite can be composed of up to 97% quartz, the remaining percentage being mostly feldspar. Sandstone is also composed primarily of quartz, formed from the compression of sand sediments. Quartz crystals vibrate in sympathy with any external applied force as the energy is reflected within the many microcrystalline faces. The use of quartz in resonance chambers increases the reverberation times observed, promoting efficient acoustic storing in the resonant systems. Silicon has driven the explosion of the 'information age' in modern times through radio receiver and microchip technologies, but its most beneficial uses in psychoacoustic architecture for vibratory healing have yet to be fully understood, despite the many astonishing Neolithic applications of acoustic levitation of megaliths evident around the world. The ancient Coptic Cross, well known from the Mediterranean and Egypt is now known to be a depiction of the apex of four-dimensional space. Mesopotamian patterned bowls depict not only the quadrupolar Prime Cross, but also the globally encircling sound waves (6.14).

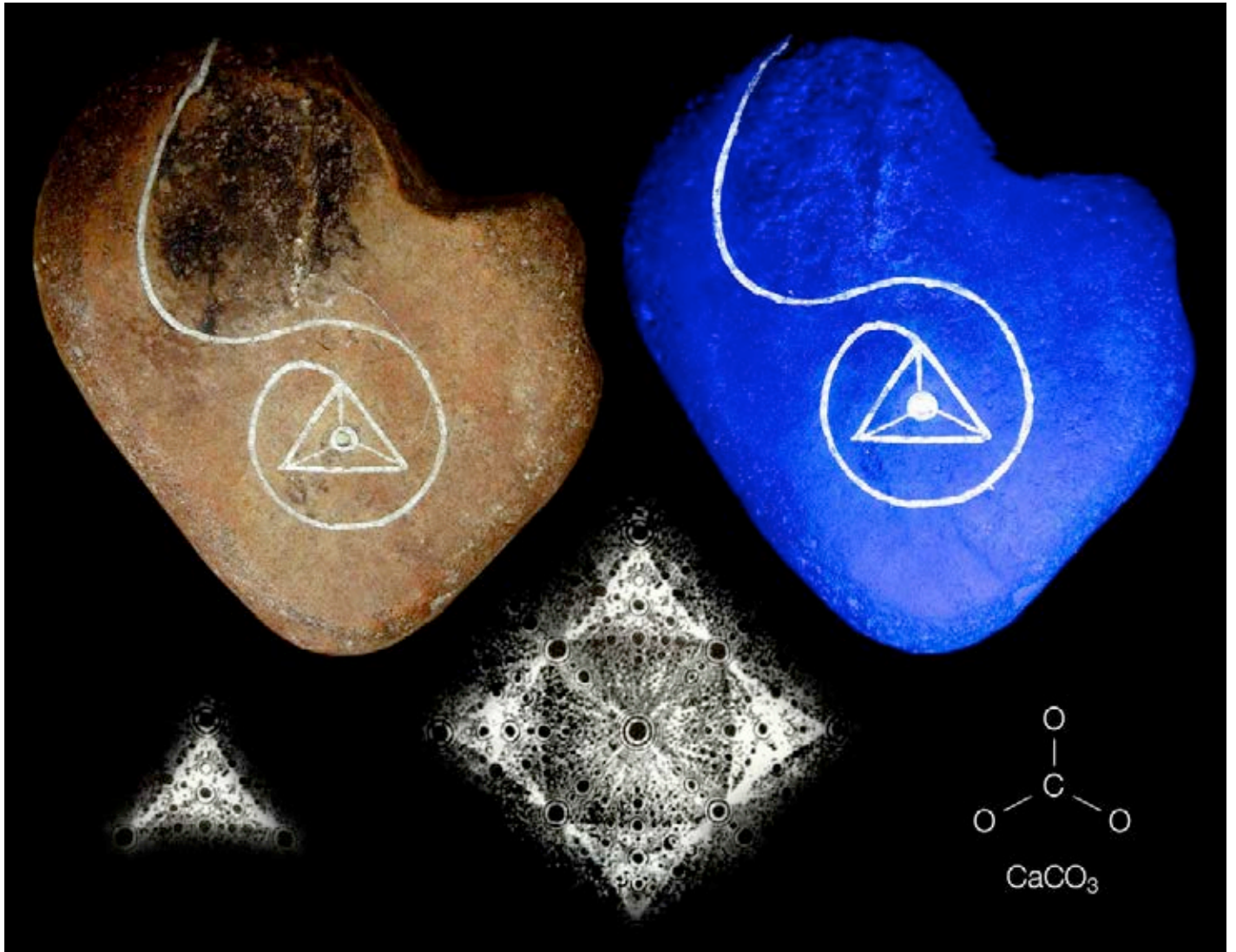

6.15. Calcite Tetrahedron stone presents the mineral's molecular structure that is inlaid to fluoresce under UV

Having already examined the octagonal crystallography revealing the refractive symmetry of calcite (6.15, bottom center), we can easily identify it again in another format among the La Maná stone sculptures, as a triangle enclosing a central circle and connected from the corners by three lines. An engraved spiraling line with geometric fluorescent inlays is presented on a bi-facial stone artifact, known as the Calcite Tetrahedron stone (6.15). On one side the stone's beige surface has been removed to reveal a dark central core that has been carved as a simple representation of a human face with closed eyes (6.16). Rising from the top of the head, or the crown chakra, is an inscribed line curving around to the reverse side of the stonework, where it extends to form a spiral encircling a phi triangle design with a central dot, in the proportion of the Orion pyramids –which are themselves comprised of mostly calcite mineral.

An identical triangular pattern is seen four-fold in calcite crystallography (6.15, bottom left), with identical angles and central dot representing the molecular structure of calcite (CaCO_3) –the carbonate group being a central carbon atom with three oxygen atoms (6.15, bottom right). Because of the octahedral structure of calcite, the limestone Orion pyramids are designed as giant fractal calcite formations! The nano-wavelengths of light scattered by calcite crystals is identical to the macro-pattern of ULF standing waves transduced at Giza. The fractal relationship described in stone is a pattern of resonance that functions on all scales. The Sanskrit pyramid technology is thus understood a wireless infrasound network that simply increases the wavelengths transduced by monumentally increasing the crystal's scale. The forgotten function of the world's pyramids is encoded in these Ecuadorian masterworks.



6.16. Reverse side of the Calcite Tetrahedron stone reveals a man's face in deep meditation –overlaid by a map

Just as observed of the octagonal stone discs (6.12), the resonant properties of the fluorescent pattern are revealed by an examination of its constituent mineral. The artist has also suggested a connection between the chakras and the refractive qualities of calcite, apparently describing the entrainment effect of limestone on the human pineal gland through calcite's transduction. This inference suggests a reading of the two faces of the artifact as representing two hemispheres of the planet; on one side the Giza Orion pyramids is represented in molecular format, with the circling wave curving around the opposite side to the entrained mind in the South American Andes. The facial symmetry is very clear, emphasizing strong cheekbones, chin and forehead, but also presents a few carved dots and lines. Another strong feature is a ridged outline seemingly overlaid onto the features. This shape can be seen as the outline of the South American continent (inset 6.16), with the southern half covered by a glacial polar cap. A dot on the left side of the contoured continental shape marks the location of La Maná with precision. A few other markings can be seen in the Andean region of the map, perhaps denoting other sacred Sanskrit sites.

The features of the face reflect a deeply receptive state of meditation, induced by the acoustic entrainment of the calcite Orion pyramids represented by the molecular mandala on the reverse side. The many-layered meanings implied through the interrelation of geometric pattern are so very precisely focused on transmitting the sacred information of resonance. Precise geometric descriptions of not one, but three aspects of the resonance of calcite are given: its molecular structure, crystallography and its property of ultraviolet fluorescence. The complex understanding of crystalline properties and nonlinear refraction demonstrated in these advanced stoneworks confirms that the ancients generated longwave ultraviolet light by the hydrino plasma reaction for the full appreciation of the fluorescence effects of their sculptures. This interpretation of the Calcite Map stone is supported by a large stone masterpiece from La Maná, this one formed of quartz-rich granite, engraved with a map of the Earth's continents during the antediluvian glacial epoch that also fluoresces under ultraviolet light.

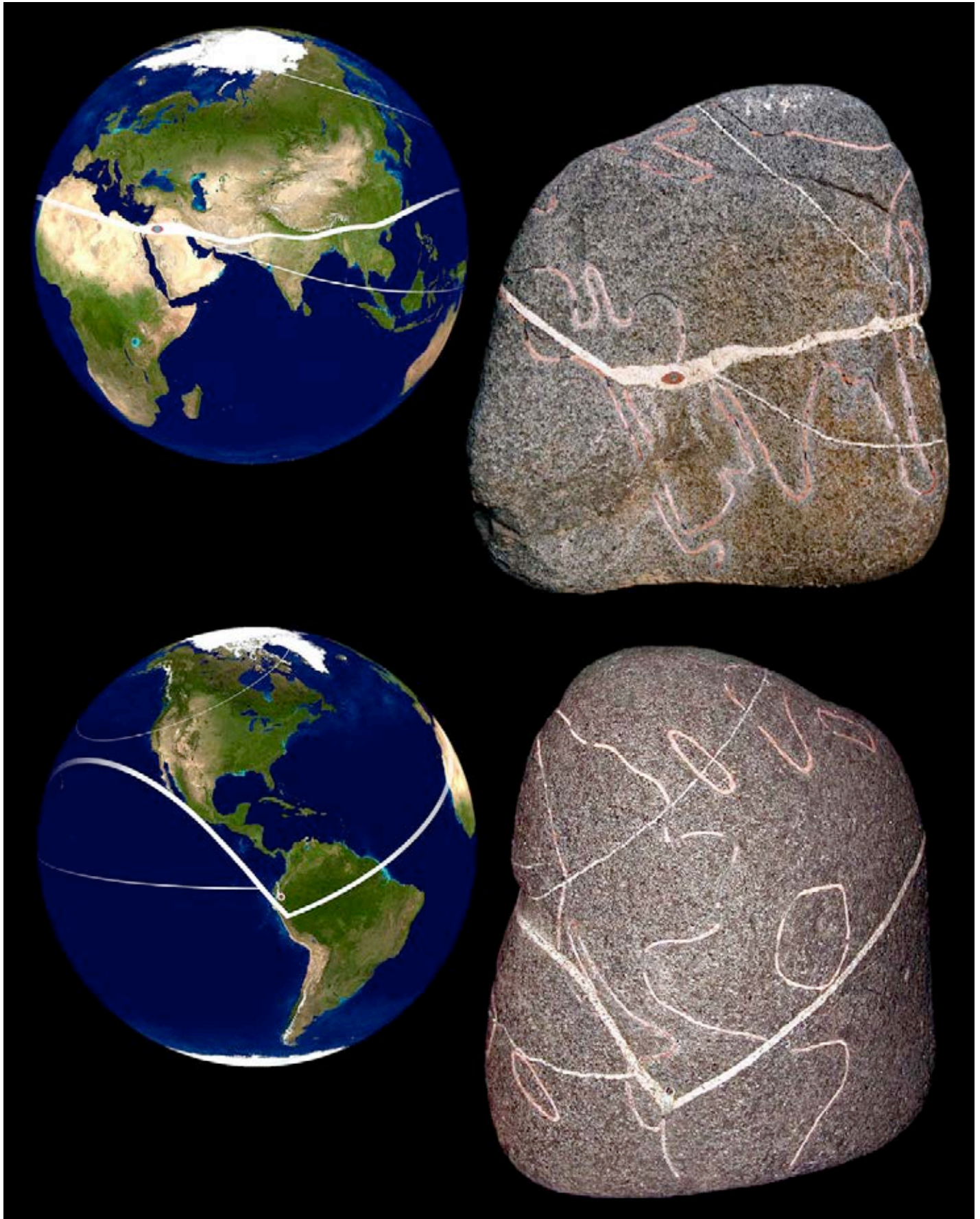

6.17. World Map stone (front and back) with inlaid continental coastlines in pink and white lines showing flight paths



The largest of the stone artifacts found at La Maná is a torso-sized engraved granite boulder with mortar-filled engraved lines and inset polished stones. The engraved contours are both shockingly familiar and strange, representing the continents of the world in what must be *the oldest map known to humanity, a global rendering from the Pleistocene* (6.17). The stone map's incised and mortar-filled lines depict the ancient coastlines in pink and another set of straight-line and curving paths in white. Anyone familiar with the shape of the modern continents of the globe can recognize a strong likeness in the artifact's complex pattern of pink lines. It has thus been named the World Map stone. The continents are quite unmistakable, one side clearly depicting Italy, Greece, the Dead Sea, the Persian Gulf and India. The coastal region of Southeast Asia is depicted rather differently than in modern maps, revealing a now-submerged landmass in an area that has been referred to by R. Schoch as Sundaland.¹²

6.18. World Map's white lines transposed onto the QIF

The other side of the stone map reveals the Americas in a somewhat different form, lacking the Caribbean Islands and Florida peninsula, yet representing large landmasses now submerged in the Atlantic and Pacific Oceans. In the middle of the north Atlantic lies a small continent that closely conforms to the Greek philosopher Plato's description of Atlantis, from the dialogues of Timaeus and Critias dating from 2,400 bp. In the Pacific region is depicted a landmass just below the equator, perhaps the size of present-day Madagascar. There is also represented a landmass extending south from what is modern Japan, long since submerged, as has been proposed by M. Kimura,¹³ whose marine archaeological dives in Okinawa and at the Yonaguni monument have informed his hypothesis that the ancient civilization of Mu once inhabited this lost land. These significant differences suggest the great antiquity of the World Map stone, as major catastrophic subduction events and sea level rise must have occurred since the creation of the stonework, placing it in the Pleistocene of more than 12,000 years ago.



6.19. World Map stone's white lines transposed onto a modern world map reveals what can only be flight paths

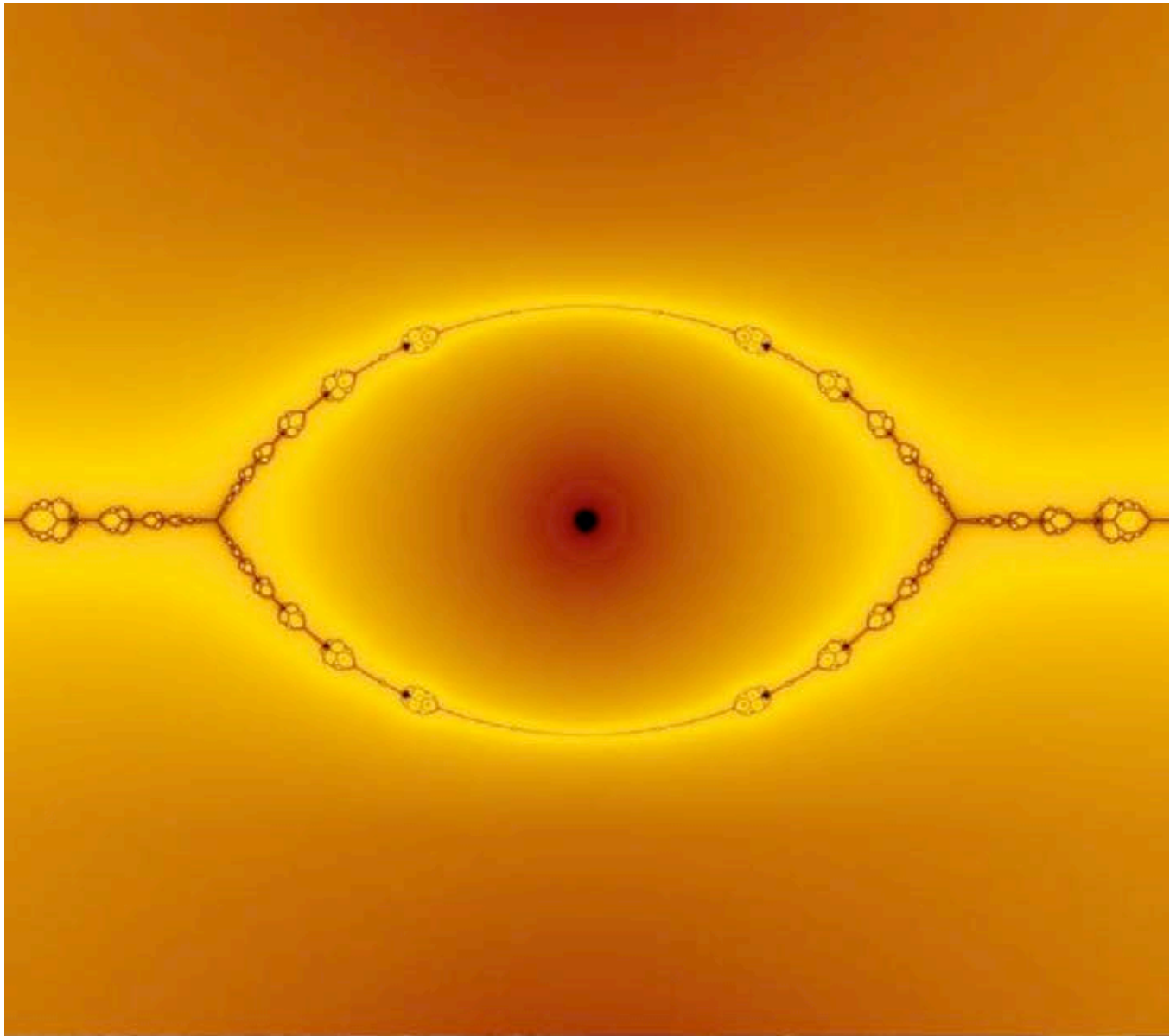

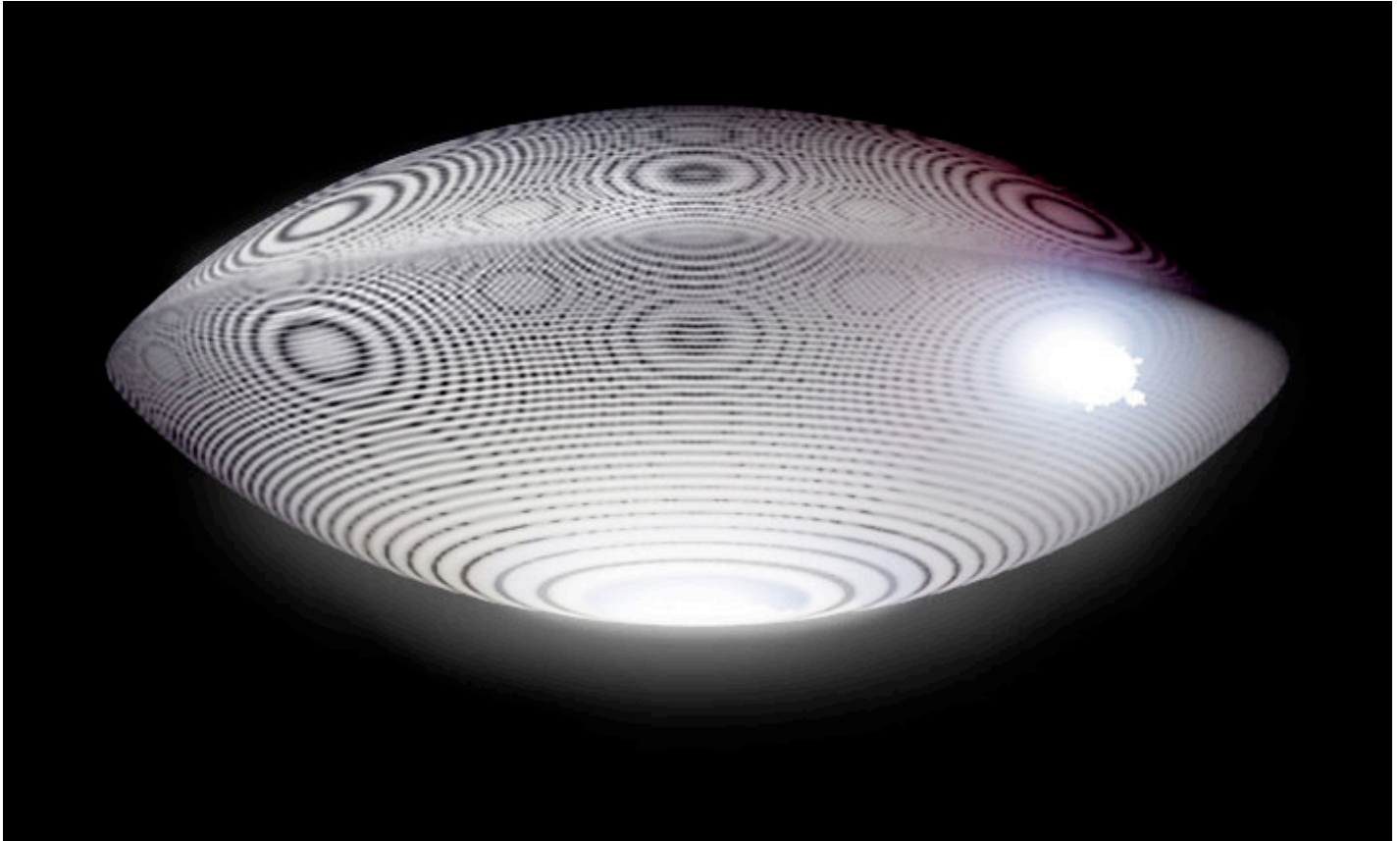

6.20. (Opposite) Quadratic function (above) informs the Sanskrit 'third-eye' symbolism and vimana craft designs
 6.21. Disc design with emitting hydrino plasmas reflecting the four-dimensional structure of Magnetic Resonance

The ancient Sanskrit *third-eye* symbol for psychoacoustic pineal gland synchronization, the *ajna* chakra, actually encodes a four-dimensional iterated function (6.20, top) as seen on the La Maná World Map and Third-Eye Pyramid (6.20, bottom). The white calcite lines that encircle the World Map stone must represent flight paths, traversing the pink calcite divisions of land and ocean (6.19). Embedded in these lines is a third-eye symbol of jasper and turquoise representing the flying vimana discs. These flight patterns precisely correlate with the Octagonal QIF (6.18) –*a projection of ULF standing wave patterns by which the vimana discs are powered by infrasound!* Sanskrit aerospace knowledge is also preserved in humanity's oldest books, the Vedas of India, which are filled with descriptions of flight and space travel. The complex technical knowledge contained in these oldest Vedic scriptures has already produced breakthroughs in material science that provide insight into one of the most deeply veiled aspects of ancient human technology - the control of gravity. Later Sanskrit texts such as the Vimana Shastra (quoting Lohatantra), Amsu Bodhini, and Kritaka Vajra Nirnaya, contain extensive metallurgical formulations of various alloys of gold, silver, copper, zinc and iron. Based on dictations of the texts and formulae by the late Pandit Subbaraya Shastri of Anekal (1855-1940), contemporary metallurgists in India have successfully produced alloys new to science by following the ancient manuals. Dr. C.S.R. Prabhu has documented several of these rediscovered alloys in his paper 'Ancient Indian Metallurgy':

- Tamogarbha Loha: Already produced in the laboratory, light in weight, black in color, found to be resistant to acids. Displayed high level of absorption for laser light... used in 'Tamo Yantra'... for the purposes of absorption of light escaping from a photochemical reaction... generating 'darkness'...
- Pancha Loha: A copper alloy, which is highly malleable and also highly corrosion resistant to moisture and salt (NaCl) water. Already produced and characterized to possess golden yellow color (Hema Varnam)...
- Arama Tamra: A copper alloy [with] zinc, lead and iron of light absorption. Already produced and possesses golden yellow to reddish tinge. Brittle, light and... very hard, Young's modulus 16.9 (described in Sanskrit text as 'Dridham')...¹⁴



6.22. Composite image of contactee 'Billy' Meier's photographs of circular Plejaren extraterrestrial spacecraft

Swiss contactee 'Billy' Eduard Albert Meier has not only provided extensive photographic evidence¹⁵ of the antigravitic spacecraft of his Plejaren friends visiting from near the Pleiades star system (6.22), but also samples of metal alloys that have astounded metallurgy experts like Marcel Vogel, former IBM laboratory scientist.¹⁶ The alloys' astounding electroluminescent and antigravitic properties are achieved by the combination of exotic metals rhenium and thulium with silver, silica and other elements. The direct application of similar advanced alloys for gravity control has been achieved in successful experiments and reported by more than one group. Brazilian physicist Fran De Aquino has precisely defined the antigravitic effects observed in the acoustic levitation of electroluminescent objects using infrasound radiation to eliminate gravity's effect:

According to the weak form of Einstein's general relativity equivalence principle, the gravitational and inertial masses are equivalent... [To the contrary,] we have shown that the gravitational mass and the inertial mass are correlated by an adimensional factor, which depends on the incident radiation upon the particle. It was shown that only in the absence of electromagnetic radiation this factor becomes equal to 1 and that... it can be reduced, nullified or made negative... by means of extra-low frequency (ELF) radiation... We have studied the possibility to control the gravity on luminescent materials and have concluded that electroluminescent materials with high refractive indices are a new and efficient solution for gravity control technology.¹⁷

Calcite is another resonant luminescent material that was used extensively in the construction of all of the pyramids of the world. The ancient Vedic accounts of antigravitic vimana, or solar ships, include recipes for electroluminescent metal alloys that display the same molecular properties as the pyramid stones, as well as showing the same octagonal axis-symmetric geometry. If antigravitic effects were once achieved in the pyramids for application to the human body and consciousness, what is the range of ultra low frequency sound biocompatibility? The heartbeat –at 1.45 Hz wavelength of 756'– informs the base length selected by the designers of the Great Pyramid of Egypt. The psychoacoustic chambers of the pyramids and the vimana discs are powered by the resonant transfer reaction of hydrino plasma.

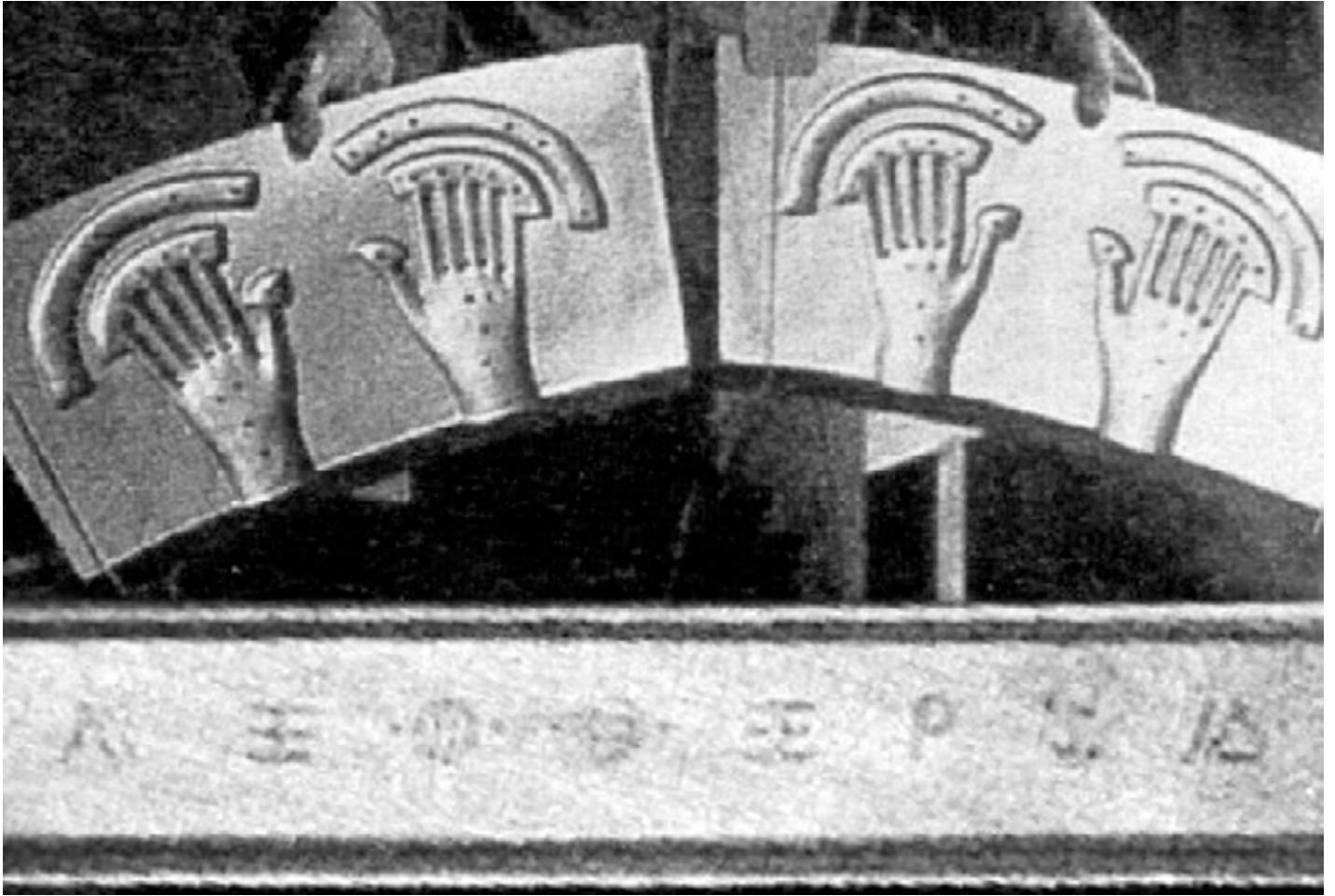

6.23. Electroluminescent metal alloys discovered in the debris field of a vimana disc crash in New Mexico, 1947

The Atlantean Sanskrit origin of vimana spacecraft *seen throughout Earth's skies today* is revealed by crashed aerial discs collected by military forces in many parts of the world. The most famous incident of this kind occurred on July 2, 1947 –allegedly near Roswell, New Mexico. Leaked US military documentary photographs and films of the New Mexico disc crash wreckage¹⁸ include dwarf humanoid corpses with *large eyes, grey skin and six fingers*, as well as fragments of highly reflective metal alloys imprinted with small six-fingered hand consoles and hieroglyphic Archaic Sanskrit inscriptions (6.23). Schildmann's epigraphic decipherment reveals the meaning of a fragmentary text from an I-beam:

Λ Ξ ·⊙· ⊖ Ξ ρ ρ Λ

kar-as tridaśa yoni śani tridaśa ku-p^a as-upama

“workings of 30 resonances, female and male, 30 resonances whereby approaching the highest”

The New Mexico I-beam text directly confirms the Sanskrit origin of the pyramids and 'UFO' phenomena. On rare occasions terrestrial humans like Mexico's Carlos Diaz and Switzerland's 'Billy' Meier have been invited to photograph and film visiting antigravitic disc craft and also enter the spacecrafts' resonant HHO plasma environment. Voluntary contactees as well as unwitting abductees describe levitation in ultraviolet beams emitted from transdimensional spacecraft just as plasma beam experiments have replicated at MIT (Ketterle, et al).¹⁹ Recently reported transdimensional experiences include riveting descriptions of intense sensations of heat and light that are consistent with advanced HHO plasma beam technology, and when analyzed in the context of the latest human technological developments one finds a profound synchronicity. Twenty-first century science has completed both the mathematical and experimental groundwork enabling a new comprehension of high-energy realms beyond common human experience.

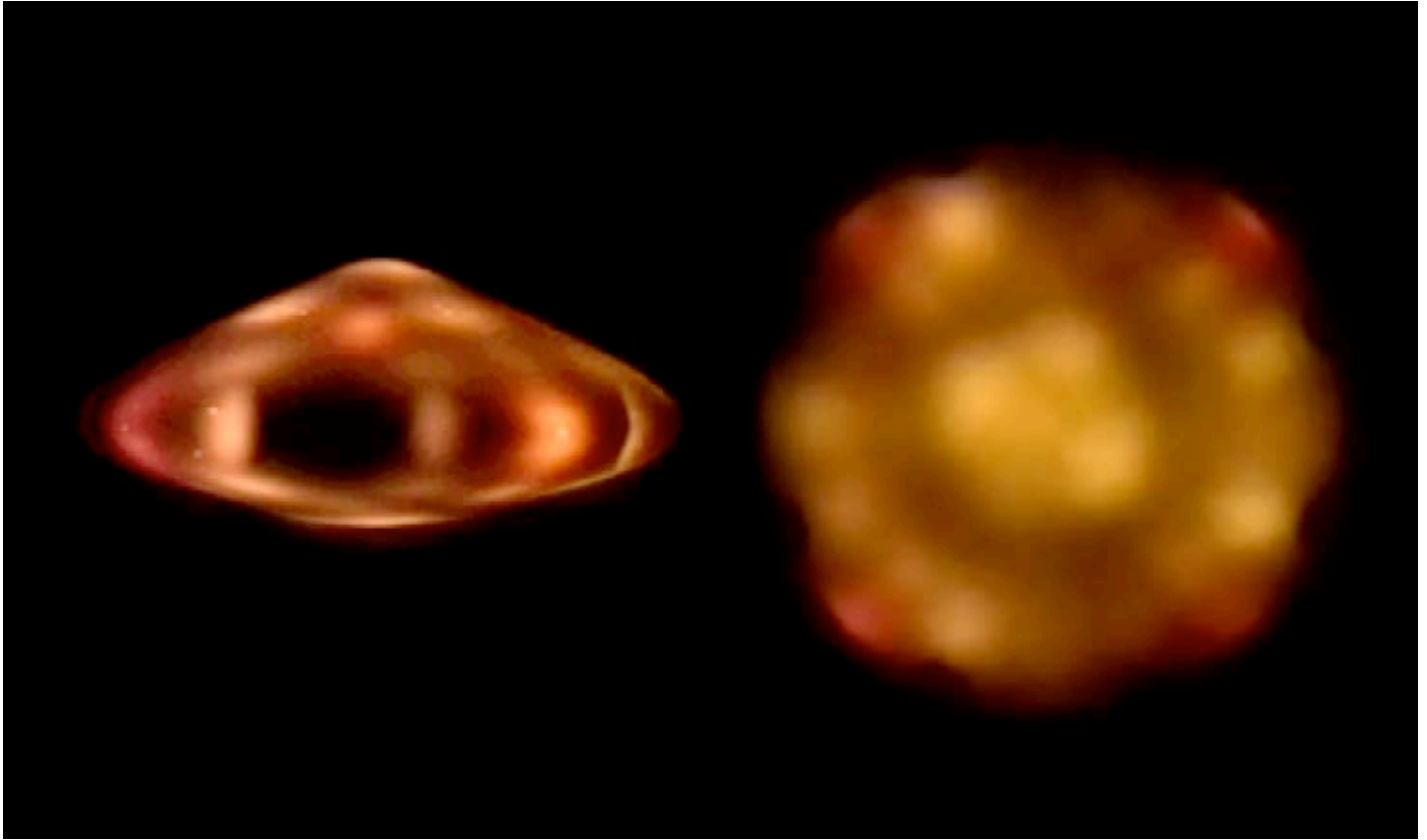

6.25. Composite video stills of an electroluminescent plasma disc recorded above Tepetzlan, Mexico by Carlos Diaz

Plasma is the fourth state of matter, with the highest energy and lowest density, followed by gas, liquid and solid states. The realm of human beings is a gas-filled resonating atmosphere in which we experience a three-dimensional world. A four-dimensional extraterrestrial realm of resonant plasmas passes through and beyond the human reality, apparently inhabited by electroluminous parapsychical beings who communicate by thought transference, also known as mental telepathy. Atomic structural changes occur in matter under the conditions of superconductivity, whereby density decreases as energy increases. This density difference between gaseous terrestrial realms and extraterrestrial plasma realms informs new terminology for their differentiation as *third-density* and *fourth-density* environments. Matter brought into the high-energy plasma environment decreases in density thus allowing molecular interpenetration. Evidence of the hyperdimensional interpenetration of matter has been found in the debris of tornadoes. One such anomaly has been described more than once - a window frame with a wood plank passing right through its unbroken pane of glass.

The fourth-density state of matter allows the vimanas' superluminal travel. Superconducting plasma aerial vehicles achieve frictionless passage through gases, liquids or solids, as there is no displacement of matter, allowing extreme velocities and maneuverability impossible for third-density objects. The wave motion of acoustic propagation that is created in a third-density atmosphere of air is not present in fourth-density plasmas, which lack the temperature differentials that bend sound into waveforms. The fourth-density environment creates a coherent energy transfer, inducing unified telepathic consciousness without any information loss as minds are electromagnetically coupled into group synchrony. The antediluvian artifacts from La Maná, Ecuador present a comprehensive mathematical formula for the resonant psychoacoustic function of the Sanskrit pyramid network and the infrasound propulsion of vimana discs in an astounding geometric archive of sub-atomic, molecular, stellar and quantum maps. These maps reveal the unified structure of Magnetic Resonance that orders the micro- and macrocosms beyond direct human perception, providing the knowledge necessary for the induction of holographic transdimensional experience and the construction of resonant hydrino plasma discs for cosmic travel.

References

- ¹ Hubbard B, Kuang W, Moser A, Facey GA, Detellier C (2003) 'Structural study of Maya Blue: Textural, Thermal and Solidstate Multinuclear Magnetic Resonance Characterization of the Palygorskite-indigo and Sepiolite-indigo Adducts' *Clays and Clay Minerals* 51:3, pp. 318-326
- ² José-Yacamán M, Rendon L, Arenas J, Serra Puche MC (1996) 'Maya Blue Paint: An Ancient Nanostructured Material' *Science* 273, pp. 223-225
- ³ Schildmann K (1999) '*Als Das Raumschiff 'Athena' Die Erde Kippte - Indus-, Burrows-Cave- und Glozel-Texte Entziffert*' CTT-Verlag
- ⁴ Kaanek G (1998) '*Mayan Time, Prophecy and the Tzolk'in*' transcript, online
- ⁵ Jenkins J (1994) 'Tzolk'in: Visionary Perspectives and Calendar Studies' *Borderland Science*
- ⁶ Vaughn V (2002) '*The Fibonacci Numbers: Connections within the Mathematics and Calendrical Systems of Ancient Mesoamerica*' online · <http://www.onereed.com/articles/fib.html>
- ⁷ Weil A (1983) '*Health and Healing*' Houghton Mifflin Co, pp. 43-44
- ⁸ Plichta P (2004) '*Deciphering the World Riddle by Cracking the Prime Number Code*' p. 4, online · <http://www.plichta.de/english/english.php>
- ⁹ Plichta P (1997) '*God's Secret Formula*' Harper Collins, p. 174
- ¹⁰ Jadczyk A (2003) '*On Quantum Iterated Function Systems*', IFT University of Wroclaw, internal report online.
- ¹¹ Plichta, op cit, p. 1
- ¹² Schoch R, McNally R (2003) '*Voyages of the Pyramid Builders: The True Origins of Pyramids from Lost Egypt to Ancient America*' JP Tarcher
- ¹³ Kimura M, Asato S, Nakamura T, Matsuura M (2002) '*C¹⁴ Age Measurement of Carbonate Samples Recovered from Tuguru-hama Ruins and Beach Rocks in Yonaguni Island, Japan*' Nagoya University Symposium online
- ¹⁴ Prabhu CS (2001) 'Ancient Indian Metallurgy' *Earthsystem Sciences Awareness and Research Association* Hyderabad, India
- ¹⁵ Meier EA (2005) 'Through Space and Time: A Photo Journal of "Billy" Eduard Albert Meier' *Steelmark* · <http://www.steelmarkonline.com/tsat.htm>
- ¹⁶ -- (1982) '*Billy Meier Contacts – Marcel Vogel Analysis*' online video · <http://youtube.com/watch?v=JwxmRfhptgA&feature=related>
- ¹⁷ De Aquino F (2000) 'Possibility of Control of the Gravitational Mass by Means of Extra-Low Frequency Radiation' *Los Alamos National Laboratory*, online · <http://arxiv.org/pdf/gr-qc/0005107>
- ¹⁸ Santilli R (1995) '*Santilli Footage, Debris*' online video · <http://www.youtube.com/watch?v=1B8cCNU-FME&feature=related>
- ¹⁹ Ketterle W, Zwierlein MW, Abo-Shaeer JR, Schirotzek A, Schunck CH (2005) 'Vortices and Superfluidity in a Strongly Interacting Fermi Gas' *Nature* 435, pp. 1047-1051



7
Celestial Water

Celestial Water



7.1. The Mitchell-Hedges crystal skull of Lubaantun, Mexico with psychoacoustic symbols –a hummingbird and water

The sandstone chambers of La Maná, Ecuador yield sacred spring waters that flow freely from several sources, as discovered by Dr. Sotomayor during his Sanskrit research. The La Maná springs still resonate an intense energy that has been the focus of thorough international investigation. This spring water is of such selective purity that it has been considered a technological feature of the inhabited cave. This situation is not unique, however, but part of an antediluvian global system of subterranean sites producing celestial waters feeding into sacred rivers at focal points of Magnetic Resonance.

The highly selective composition of the La Maná water has been documented in several laboratories around the world; its most astounding feature being spherical nanoparticles of gold and silver less than 10nm in size that are potent antibacterial and even antiviral agents. *Electrum* is the ancient alloy comprised of gold and silver that incorporates the ductile properties of the two precious metals while being inert (without any chemical reaction to water). Electrical conductivity in the human body is usually highest in the bloodstream, as its greater salinity allows greater conductivity than less saline cellular water. However, a body fueled exclusively by colloidal gold and silver water of optimal nanoparticle size induces an extremely enhanced electrical conductivity throughout the entire body.



7.2. Profile of the Mitchell-Hedges quartz crystal skull allegedly found within the Lubaantun pyramid ruins of Mexico

Salinity reduces the ability of a colloid to suspend nanoparticles, showing that elimination of salt from electrum water allows for maximum suspension. The suspended gold and silver nanoparticles are highly reflective of light and sound, vastly increasing the resonant characteristics of the human body. Polarized light photography of frozen La Maná electrum water crystals¹ (7.5, page 146) reveals the refractive qualities of a prism that allow enhanced luminous, acoustical and electrical capacity in the human body. The geometry encoded in La Maná's stone, clay and metal masterworks details a bioenergetic technology that allows the crystallized human being to find resonance with sacred stones. This most advanced artifact of ancient culture has returned to human use, revealing the complex and subtle meaning behind an ayurvedic adage echoing deep within the forgotten human past: *'make a temple of the body.'* Used in conjunction with the pyramid sites of the Maya are the Crystal Skulls, advanced mnemonic instruments employed in the activation of consciousness. The quartz crystal skulls were hewn in ancient times using HHO plasma torches (the only method capable of sublimating quartz into such anatomical masterpieces) fed by HHO plasma chambers that once burned inside the pyramids.



7.3. Aztec quartz crystal skull from the collection of the British Museum, on display at the London Museum of Mankind

A human body fueled by sacred electrom waters undergoes of quantum shift in its electrical capacity. The enhanced electrical conductivity and desalination of the body imbues the resonant body with the resonant properties of quartz, the very concept of bodily crystallization conveyed through the crystal skull symbol itself. Sacred electrom waters were the key element in the body purification processes for which the pyramids of the world were designed. Rather than a mere rite of passage, the concept of *initiation in the pyramids* thus refers to the transformation of the human body into a *high-capacity superconductor!*

This extremely advanced scientific knowledge was passed on orally and eventually recorded textually in the Vedantic teachings of ancient India. These sacred texts use a poetic and easily accessible terminology to describe with astounding scientific and technical accuracy the spiritual cosmology within which one can grasp the remarkable transformative properties of electrom waters. These breakthroughs have yet to be employed in mainstream human technology, although the Vedas and subsequent Sanskrit texts preserve myriad metallurgical instruction manuals and advanced technical discourses.



7.4. American red jasper crystal skull with inlaid acupressure points

One particular dialog discusses sacred rivers on whose banks accumulates a precious form of gold called Jambunada. The Srimad Bhagavatam, quoted here in the original translation of Swami Prabhupâda, hints at the nature of the energetic effects of colloidal gold and silver in the human body. One finds an insightful discussion of golden waters in the Description of Jambudvîpa (Canto 5, Ch. 16).² The dialog of King Pariksit and Sukadeva Gosvami investigates the form of *Bhu-mandala*, our energetic solar system. The size and relative locations of many mountains, oceans and fruit-bearing trees are discussed, yet the gigantic scale given for these mountains and trees - thousands to millions of miles in diameter - denies a literal interpretation. The reader is forced to accept that these are metaphors for invisible cosmic energy forms that imbue all life with consciousness. The human scale is reconciled metaphorically with the cosmic scale by referring to planets as mountains and the axis mundi or 'tree of life' as gigantic trees thousands of miles high bearing elephant-sized fruit:

When all those solid fruits fall from such a height, they break, and the sweet, fragrant juice within them flows out and becomes increasingly more fragrant as it mixes with other scents. That juice cascades from the mountain in waterfalls and becomes a river called Arunoda, which flows pleasantly... (Text 17)

[As] the pious wives... drink the water of the River Arunoda, their bodies become fragrant, and as the air carries away that fragrance, it perfumes the entire atmosphere for eighty miles around... (Text 18)

The mud on both banks of the River Jambu-nadi, being moistened by the flowing juice and then dried by the air and the sunshine, produces huge quantities of gold called Jambu-nada. The denizens of heaven use this gold for various kinds of ornaments. Therefore all the inhabitants of the heavenly planets and their youthful wives are fully decorated with golden helmets, bangles and belts, and thus they enjoy life... (Text 21)

The residents of the material world who enjoy the products of these flowing rivers have no wrinkles on their bodies and no grey hair. They never feel fatigue, and perspiration does not give their bodies a bad odor. They are not afflicted by old age, disease or untimely death, they do not suffer from chilly cold or scorching heat, nor do their bodies lose their luster. They all live very happily, without anxieties, until death. (Text 25)

In this astoundingly detailed description from Sanskrit traditions in India, we learn of the golden waters of heavenly planets and their unusual and extremely beneficial effects. This heavenly golden river water exists exactly as described in La Maná, Ecuador, found complete with "golden helmets, bangles and belts" and an entire collection of over three hundred masterpieces with Sanskrit symbolism. To this day the La Maná sacred spring water site produces vast quantities of purified ayurvedic electrum water that flows into various rivers. If this energetic water is the product of an ancient subterranean technology, how are the purification chambers and colloidal generators still functioning? The answer lies in La Maná's (0.95°S 79.18°W) GPS relationship with the pyramids of Giza, Egypt, exactly 7,470 miles away. This distance is significant as it is precisely 30.0% of the earth's mean circumference of 24,892 miles, reflecting the



7.5. La Maná water as ice crystals under polarized light (G. Schön)

Fibonacci ratio of 2:3:5. This exact geoposition receives maximum cosmic infrasound standing wave resonance focused by the Orion pyramids, which is why the Atlantean Sanskrit texts continually associate the number 30 with the life-giving acoustic influence of Jupiter. Planetary infrasound resonance informs the precise location of the La Maná celestial water site, described in the Srimad Bhagavatam dialogues as being at the root of the Sacred Tree, from where the fragrance of celestial water vapors are dispersed for 80 miles around.

Descending the slopes of the mountains adjacent to La Maná are sandy streambeds fed by the sacred water springs. Reflecting clearly through the pure waters are shimmering flecks of gold. This feature of the streambeds originally drew the attention of gold prospectors like Dr. Sotomayor, whose investigations lead to the chance discovery of the large subterranean cache of Sanskrit artifacts. A visibly significant accumulation of gold nanoparticles in river sediments may be due to a weak electroplating effect of an alternating current transduced by the highly conductive spring waters. The Jambunada gold of the La Maná site was used in antediluvian times to form the helmets, belts and bangles and other jewelry used to enhance group consciousness by tri-thalamic synchronization.

Quite intriguingly, the long-term biophysical effects attributed to the celestial water of the River Arunoda described in ancient Sanskrit texts include the prevention of grey hair, disease, anxiety and the appearance of aging. The holistic rejuvenation ascribed to drinking Arunoda's waters also affects *the temperature sensitivity of the skin*, allowing a higher tolerance to temperature extremes. Another significant attribute of bodies fueled by celestial water is odorless perspiration. All of these specific physiological changes are the result of the high conductivity of colloidal electrum water.

The antibacterial and ductile properties of *silver* have been well known for centuries, having been used effectively against many forms of infection including AIDS, cancer, Epstein-Barr, gonorrhea, Lyme disease, Candida, fungus, warts and parasites. Only recently has it regained widespread use in liquid colloids that maintain a positive electrical charge. High-grade colloidal silver is reported to be nontoxic, as any excess that is not needed by the body is easily eliminated, preventing the toxic accumulation of metals in tissues that can occur when low-grade colloids are ingested. Known cases of massive overdosing with high-grade nano-silver show no negative effects, *except blue skin*³ (*Hindu Gods Vishnu and Krishna have blue skin*). Furthermore, there is no known interaction between high-quality silver or gold colloids and any medicinal drugs. The nanoparticle size-range allowing colloidal silver's antiviral efficacy have only recently been reported by Elechiguerra et al. in the *Journal of Nanobiotechnology*:

The interaction of nanoparticles with biomolecules and microorganisms is an expanding field of research. Within this field, an area that has been largely unexplored is the interaction of metal nanoparticles with viruses. In this work, we demonstrate that silver nanoparticles undergo a size-dependent interaction with HIV-1, with nanoparticles exclusively in the range of 1–10 nm attached to the virus. The regular spatial arrangement of the attached nanoparticles, the center-to-center distance between nanoparticles, and the fact that the exposed sulfur-bearing residues of the glycoprotein knobs would be attractive sites for nanoparticle interaction suggest that silver nanoparticles interact with the HIV-1 virus via preferential binding to the gp120 glycoprotein knobs. Due to this interaction, silver nanoparticles inhibit the virus from binding to host cells, as demonstrated *in vitro*.⁴

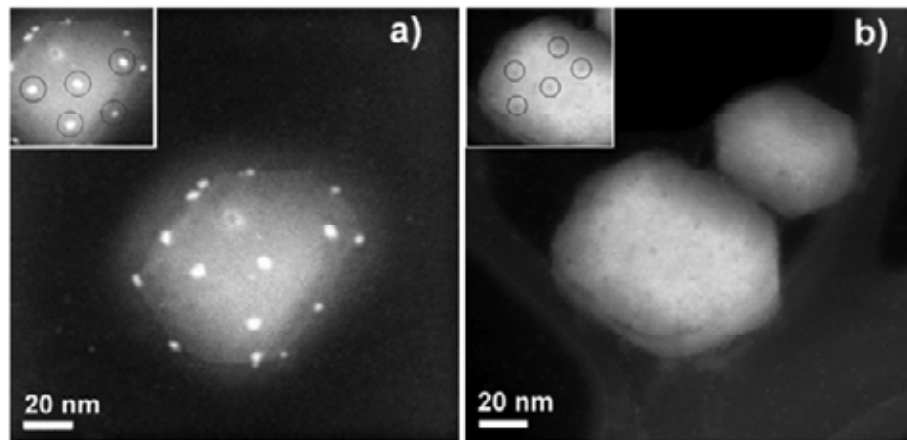

7.6. HAADF images reveal the interaction of silver particles (3-7nm) with HIV-1 virus
a) Silver nanoparticles bound to the HIV-1 virus appear as evenly spaced white dots
b) Dark spots mark the gp120 glycoprotein knobs by which HIV-1 binds to host cells

The antiviral effect is related to the anatomy of the virus itself, as only 2-10 nm particles may bind to HIV-1's glycoprotein knobs. The researchers found that exposure to this precise size range of silver completely killed the HIV-1 virus in three days. Death of the virus occurs rapidly after the binding of the silver denies the functions of the glycoprotein knobs that are vital to the survival of the virus.

The cave site at La Maná yields a spring water of such selective purity that, in light of the dramatic health effects and corresponding ancient traditions observed, it must be considered a technological feature of the once-inhabited cave sacred site. This energetic water contains colloidal gold and silver nanoparticles of less than 10 nm in size, as well as several other unique properties not found in springs anywhere else in the world. The electrum water from La Maná contains mineral levels optimal for cellular maintenance and harmonic oscillation, suggesting ancient ayurvedic selective design to fuel crystallization of the human body. Suspended in a medium characterized by essential bicarbonates and extremely low sodium levels, the colloidal gold and silver and dissolved CO₂ penetrate throughout the cells. Carried by this purified crystalline water, nanoparticles of the colloidal metals enter into a positively charged, gas-like state, vibrating in the unified quantum mechanical wave.

The extremely high electrical conductivity of this ancient technological spring-water promotes an antibacterial environment by positively charging the cellular water, while the antiviral effect also includes the silver nanoparticles' aggressive and lethal bonding to viral sulfurs. The use of direct electrical current as a delivery mechanism for nanoparticles to penetrate into all of the body's cells has been widely developed in the last two decades as 'electroporation'. Researchers established that the cell membrane permeability barrier may be suppressed temporarily and reversibly by subjecting a cell to brief, high-intensity, pulsed electric fields. Electric pulse-induced permeation of cellular membranes, generally referred to as electroporation, causes all of the micropores in cell membranes to open simultaneously. This effect has been employed extensively in the therapeutic delivery of large molecules into the cell body, yet further applications of this method will enable the removal of heavy metal contaminants from the body, such as the airborne radioactive Depleted Uranium dust now extensively poisoning the world's atmosphere.

Alignments of magnetic nanoparticles in liquid colloids induced by alternating magnetic fields have been recently shown to direct current flows within the liquid (7.7), suggesting that the cell purging that occurs during bioelectrification is greatly enhanced by the magnetic formation of nanoparticle snakes aligned with the movements through cell pours:

Alternating magnetic fields create snake-like chains of magnetic particles suspended in fluid. The snakes direct the flow of the surrounding fluid along their lengths, potentially leading to new methods to control fluids in chip-based chemical analysis... The team's recent experiment shows that the speed of the water flowing along the snake depends on how quickly the magnetic field alternates... The nickel spheres aligned themselves head-to-tail with nearby particles as though they contained tiny bar magnets.⁵

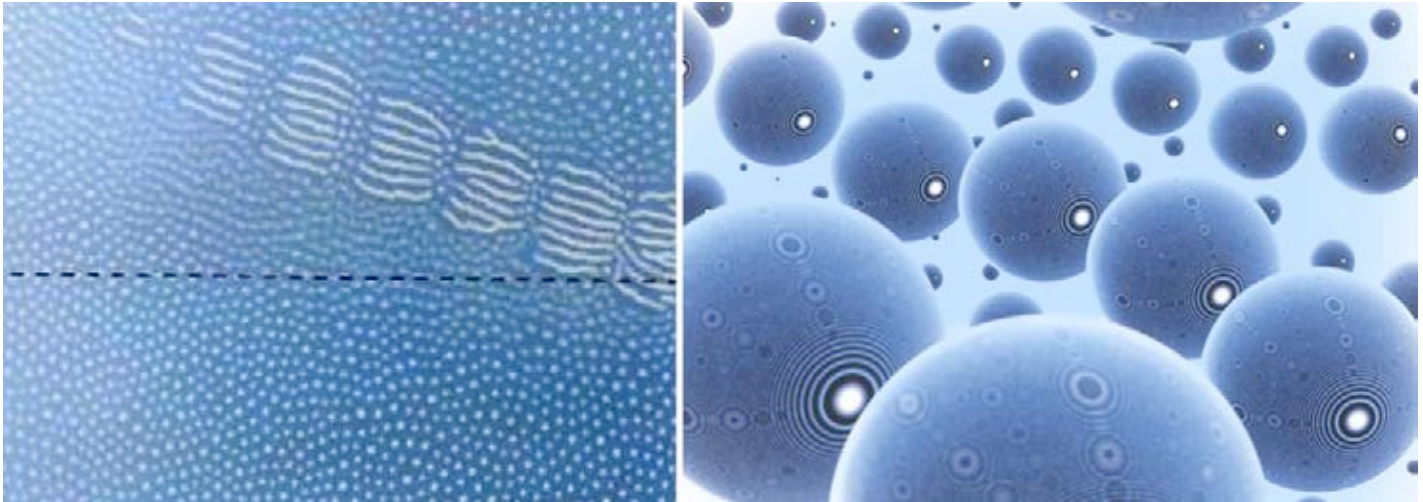

7.7. Colloidal fluids with suspended magnetic nanoparticles form snake-like chains as dipoles align (diagram at right)

The snake-like dipolar alignment of groups of nanoparticle chains is exactly described in the ancient Sanskrit symbol of *the double-headed serpent, perfectly depicted in the Atlantean metalwork from Cuenca, Ecuador (5.8, page 102)*. Could these 'magnetic snakes' form in the gold and silver nanoparticle colloids? Gold and silver do not normally display magnetic properties. However, recent research has revealed that nanoparticles of gold, silver and copper actually become magnetic at the size of 2nm, confirming that magnetic snakes do form in gold and silver nanoparticle colloids!⁶ The ancient kundalini masters of Ecuador left a remarkable record of their methods of bioelectrification. These profound Atlantean artworks overtly show us that drinking *the living waters from the living stone* is a key component of the kundalini process of bioenergetic enhancement achieved by purification of the human body to become an efficient acousto-electric transducer —*a temple*.

Exclusively drinking the La Maná electrum water is the first step that crystallizes cellular water and loads millions of gold and silver nanoparticles into the body that facilitate the transmission of microampere currents through the feet to the spinal column and the top of the head. The enhanced permeability of the body by electroporation increases the cellular fluid exchange by over seven times the normal rate, dramatically increasing the sensitivity of the body to chemical alteration. Any chemicals delivered into the system through electroporation will be seven times as potent, thus requiring a strict set of treatment protocols for the purification of the body. *Ingesting any chemicals during or days prior to electroporation can be lethal*, while the presence of even acids from garlic or onions in the body can be detrimental. My own trial with these curative celestial waters involved drinking 126 liters of commercially bottled La Maná spring water over the course of 38 days beginning on December 20, 2005, after I had contracted Lyme disease from a deer tick bite while hiking. The first week of my detoxification process completely eliminated the Lyme bacteria from all of my cells, and caused flu-like symptoms as my body purged all of the dead bacteria from my system. *I was cured!* The last month of my electrum water trial was spent feeling revitalized and relieved of all of the Lyme disease symptoms as I spent many hours every day walking the long the beaches north of Montañita, Ecuador —barefoot and gazing at the setting sun.

The La Maná spring water was previously being bottled under the brand name *Splend'Or* and sold in Ecuador, Japan and Austria. *The producers of this sacred ayurvedic electrum water were subsequently bought out by secretive front companies who have halted the production process in the interests of the corrupt pharmaceutical industry –in a failing attempt to hide the powerful curative effect of colloidal silver and gold, which can effectively kill all pathogens including viri and bacteria, thus rending the inferior pharmaceutical products worthless.* The bottler has provided the following values for La Maná spring water, based on 16 analyses⁷ conducted by different laboratories in the United States and Europe:



Physical/Chemical Analysis

<i>Composition</i>	<i>Units</i>	<i>La Maná</i>
Dissolved Solids	mg/l	33
Conductivity	µs	71
pH		6.5
Calcium	mg/l Ca ++	5.1
Magnesium	mg/l Mg ++	3.7
Sodium	mg/l Na ++	4.0
Kalium	mg/l K +	1.0
Total Alkalinity	mg/l CaCO ₃	36.0
Chlorides	mg/l Cl -	3.0
Gold		traces +
Silver		traces +++

Resonant Characteristics

- Acid pH** By pharmacopoeia standards, a water to be used in the making of pharmaceuticals must have a slightly acid pH below 6.5. The subterranean source at La Maná yields water with a slightly acid pH between 5.5 and 6.0, and during the bottling process holds a pH level between 6.5 and 7.
- Dissolved CO₂** The presence of CO₂ has proven digestive effects, and carbonated waters have been produced for this reason. In the case of La Maná, springs emerge from the subterranean soils with dissolved CO₂ between 250 and 300 parts per million, in the form of microbubbles.
- Dissolved Solids** The World Health Organization defines good quality water as having less than 500 mg/l of total dissolved solids. Highest-quality water has a total dissolved solid content of less than 50 mg/l, being considered to have minimal mineralization. La Maná spring water has 33 mg/l, making it a water of extraordinary quality and creating a resonant environment for harmonic cellular development. The small amounts of minerals or dissolved salts are conformed almost exclusively by bicarbonates of calcium, magnesium, sodium and potassium, and by some other chloride. In reality we are dealing with a true rarity: a water that has practically no salinity.
- Colloidal Gold & Silver** The quantum resonance of this rare water is allowed both by its purity and by its trace content of colloidal gold and silver. These precious metals are the constituents of the ancient sacred alloy known as electrum, allowing an extreme conductivity of 71 µs and creating an antibacterial and antiviral environment within the cells. Nanoparticle sizes of less than 10 nm allow the colloidal metals to act as a dissolved gas capable of penetrating throughout the body's cells to achieve biorhythmic resonance.

The modern medicinal use of silver nanoparticle colloids (without gold) was researched and introduced by Dr. Bob Beck, who documented successful cures in hundreds of cases of severe viral infection, especially the HIV virus and Hepatitis C. Beck's Blood Electrification Protocols⁸ provide careful guidelines for achieving a successful bioelectric purge of all pathogens *from the entire body*. Beck reliably used two hours per day for 4-weeks of treatment with alternating electric currents of 100 microamperes, including an initial build-up period increasing exposure by 20 minutes every day. The build-up phase is helpful in mitigating the initial purging of the pathogen load from the system –in some cases the purging is significant enough to cause flu-like symptoms as extreme demands are placed on the liver and kidneys in processing the toxic pathogen waste that results from a successful bioelectric treatment. In cases of severe infection the purging process should be taken slowly.

As Dr. Beck often noted, “a patient cured is a client lost,” and for this reason a policy of suppression of one of the most astounding medical breakthroughs of our time has been effectively upheld by the petrochemical industry, *which is now obsolete*. The inspiration for Beck's bioelectrification ideas came directly from the work of W. Lyman and S. Kaali who, in 1990, first published their research regarding the application of direct electric current to human blood and its beneficial effects of eliminating blood pathogens and providing a previously unidentified alternative source of ATP for cellular metabolism:

The results reported here demonstrate that HIV treated with direct electric currents from 50 to 100 uA has a significantly reduced infectivity for susceptible cells in vitro. This reduction of infectivity correlates with the total electric charge passing through the chamber... With respect to the biocompatibility of the electric currents and total charges reported here, two separate sets of evidence are applicable. The first has to do with the results showing that, by trypan blue exclusion, no significant cytotoxicity was induced in H9 cells by any total charge tested. The other evidence is obtained from reports which clearly indicate that the amount of electricity used for these experiments is significantly below presently used therapeutic electric currents which are in the milliamperage range.

Rather than negative effects, exposure of cells to electric current may actually have positive consequences for resistance to infection in that important cellular electrochemical changes correlate with enhancement of specific enzymatic activities. In particular, a facilitation of succinate dehydrogenase (SDH) and ATPase activity has been observed. Both of these enzymes are associated with the oxidative capacity of the cell. Specifically, it has been suggested that an electrochemical reaction occurs between mitochondrial membrane-bound H⁺-ATPase and ADP leading to the formation of ATP. *Therefore, exposure of cells to direct electric current may directly or indirectly increase energy resources within a cell and facilitate cell metabolism.* This, in turn, may actually render a cell less susceptible to the effects of viral infection.⁹

The profound implications of these final speculative statements made by Lyman and Kaali cannot be overlooked. *In layman's terms – all cells may be fueled not only by digestion but also by subtle electrical current!* Can this actually be true? Further experimentation will very quickly elucidate this tantalizing possibility, yet teachings from the depths of the human past provide corroboration. Insight into the transcendence of normal human metabolism may be found in the ancient Sanskrit tradition known as sungazing or sun yoga. It is an essentially ascetic practice of abstinence from food to take sustenance only by gazing at the sun during twilight hours, combined with barefoot walking at sacred sites. The astounding achievements of sungazers who have developed this *solarian* metabolism have been documented thoroughly in the case of Hira Ratan Manek, a sungazing yogi *who has not eaten food in over a decade*.¹⁰ This is why all ancient peoples were sun worshippers. The Beck Protocol places electrodes at the arteries of the wrist, yet the barefoot sungazer receives a microampere electrical current through skin contact with the piezoelectric earth, sand and stones. This apparently separate and essential way of fueling cellular metabolism can be understood as a kind of *spiritual metabolism*. The pyramid-building Maya specify *two classes of human beings* by their differing forms of metabolism:

One class is the ordinary man, naked, inert, always menaced by death's darts. The other class is the superior man. In the shade of the altar the maguey spines of penance become for him the wings of the soul, and in his hands he harmonizes the four states of matter. He has achieved consciousness. He has achieved the power of Truth and can act. He is! The other man is like an agonized animal tied to the tree from which he eats. He gives his vital energy to Tecciztécatl, the Moon... The superior man feeds on sacrifice; he develops his soul and his soul becomes food for Tonatiuh, the Sun. So... the soul of the liberated man rests on the Hill of Heaven.¹¹

The timeless wisdom of the Maya tell us that the spiritual metabolism of the superior man is fueled by sources of celestial water, like those that flow from the subterranean chambers of La Maná, Ecuador:

Tláloc, God of Celestial Water, god of the vapor that *rises*, from the earth warmed by the sun after the rains, god of the mist that *ascends* from the valleys at dawn, god of the water that returns to its source in the clouds that swim over the highest peaks, god of the humid incense from which rise the copal prayers and the prayers of sacrifice... Tláloc is the return of vapor that strains to rise, is the return of time that strains to *remember*. Tláloc, God of the Fight Against the Current, with whose aid the hero battles against the torrent toward his own origin and beginning, towards the wings of his soul, the wings that Tláloc hides in the hero's past...

But in their hearts and in their semen, each man *has his own* coatl, his own serpent, the energy of Tonatiuh, the power of the sun itself. And in this serpent sleeps consciousness, in this serpent is hidden his divinity. From this serpent his wings will grow... In the ordinary man, the serpent has but one head –hurting and cruel, and lacking control of the energy of Tonatiuh and its gift of consciousness. The energy slips from her, becomes venomous. The ordinary man cannot conserve it or utilize it. But he who searches learns to turn the serpent inward and the serpent wounds the enemy that it carries within itself. It shoots within and without and creates the two-headed serpent. The hero learns a great secret by knowledge, effort, sacrifice, and love. He sheathes his serpent incisors and makes her swallow her own venom. And from the digestion of this venom grows the wings of the spirit. Quetzalcóatl, the Plumed Serpent, has been born in him. He moves between gods and men.

There is an occult energy in the heart that comes from Tonatiuh, the Sun, and if man releases it, returning it consciously to the Sun, he becomes immortal. But to liberate this energy, sacrifice is necessary. Man must sacrifice the desires and habits that he adores, sacrifice them in himself, and turn the knife against the enemy that he carries within himself, that keeps his heart a prisoner.



In recent times men still remembered these words, but they have now forgotten their significance. They have made enemies of other men to sacrifice them and take out their hearts, believing such offerings would propitiate Tonatiuh. Such is their degeneration, such is their superstition. When fear unites with knowledge, terrible things are done. It is the self within ourselves that we have to sacrifice. It is our own heart that has to be torn out of the false being and offered to the light.¹²

Here are explicit instructions from the Maya that ring true to their ancient Sanskrit roots and elucidate the latest findings of modern cellular biology. The 'occult energy of the heart' is the kundalini energy –*bioelectrification*– that can energize the human body fueled by celestial *electrum water*. Furthermore, the Maya inform us that the superior man who fuels himself through this spiritual metabolism becomes immortal by sungazing! The ceramics from La Maná elaborate this kundalini technique of spiritual metabolism by showing the methods and equipment used, including psychoacoustic helmets on both adults and infants, in addition to the partaking of electrum water and walking the sacred earth with bare feet (7.8, 7.10)

7.8. Psychoacoustic helmets on an infant and woman holding a cup



7.9. Ceramic cylinder seal, psychoacoustic whistling vessel formed as an owl and a pyramid seal with a winged bat

These intricate masterpieces demonstrate the precise manner in which the gold helmets and other objects were used as resonators to tune human collective consciousness into biorhythmic synchrony. The ancient Sanskrit psychoacoustic tools include several tri-frequency whistling vessels, including one beautiful example formed as an owl, holding a snake in its talons and beak and displaying concentric mandala patterns in each eye (7.9, center). The three-tiered dot patterns on the owl's wings encode the tri-frequency psychoacoustic output of its whistle, just as seen in the tri-frequency whistling kundalini mask from Bolivia (2.12, page 29). One of the many ceramic cylinder seals found below La Maná imprints a double row of human figures holding hands, their heads designed as concentric circles, a clear reference to group psychoacoustic synchrony (7.9, left). A clay stamp is formed as a bat with zigzag waves in his wings and body, above the Great Pyramid, a reference to inaudible echolocation (7.9, right).

After discovering the cache of La Maná relics, Dr. Sotomayor reconstructed the broken artworks himself. After gluing the ceramic pieces from fragments he also (unfortunately) repainted several of the clay figures to emphasize incised patterning, perhaps not realizing the great antiquity of these Sanskrit masterworks and the importance of preserving the original surfaces. Lack of funds for proper conservation of the artifacts also resulted in a lack of documentation of the cave sites where these relics were found while gold prospecting, thus requiring more advanced and costly laboratory methods to determine their age. As this collection of Sanskrit artifacts from Ecuador gains worldwide attention, funding of scientific analyses for the accurate dating of the materials will provide crucial information on their antediluvian origin. By contrast, the astounding characteristics of the site's sacred waters have garnered significant worldwide attention, funding and analysis from the scientific community, who have altogether ignored the site's Sanskrit artifacts that explicitly prescribe the effective energetic use of this electrum water. This compounded ignorance of the water nanotechnology's cultural origins has denied its proper curative use, which will end the sufferings of disease among humans when used holistically.





7.10. (Opposite) Paired figures demonstrate maternal psychoacoustic entrainment functions of ceramic funnels
 7.11. Ceramic figure with birds, psychoacoustic helmet and panpipe; another uses bioelectrification equipment

Among the most enigmatic ceramic masterpieces from the La Maná collection is a pair of figures about 3' in height displaying advanced bioelectrification devices. One figure holds a studded scepter and is dressed in a hooded suit covered in horizontal ridges that give it the appearance and function of an electrical transformer (right, 7.11). The bodysuit is reminiscent of an astronaut's spacesuit designed to enclose the entire body, with the exception of the face, hands and feet, to control the body's environment – in this case for the purpose of bioelectrification. Another figure (7.11, left) is likewise adorned with



7.12. Female and male ceramic figures with psychoacoustic helmets, ear plugs and engraved with waveform designs

nose, ear and chin piercings for conductive metal ornaments including a nosepiece with paired birds and long earpieces with birds and zigzag waveforms. He wears metal bangles and a psychoacoustic helmet covered in piezoelectric granite 'antennae' stones; and in his hands appears to be a complex psychoacoustic panpipe. In fact, *all of the ceramic figures from La Maná are clearly depicted as barefoot, and all of them are wearing extensive metal facial jewelry and some kind of psychoacoustic metal helmet or ceramic funnel headpiece.* Circular bangles are common. Female figures often stand or sit with water jugs or cups on a circular pedestal with octagonal banding (7.10, 7.12). Various figurines were delicately incised with lines, spirals and repeated wave patterns representing the simultaneous acoustic and electric effects of the kundalini energetic processes being demonstrated in this set of sacred sculptures.



7.13. Gold psychoacoustic helmet with an opening at the crown chakra and a set of 12 dodecahedral magnetite crystals



7.14. Ceramic figure with bangles, snakes, shells, ear plugs and psychoacoustic helmet; and two mandala discs
 7.15. (Opposite) Psychoacoustic helmets used by a human figure standing on a reptilian being on a toroidal base

One full-size, perfectly hemispheric gold helmet (7.13, top) was discovered among the La Maná collection –fitting the normal head size of an adult just as depicted in the ceramic sculptures that demonstrate their manner of use. Its pure, perfectly rendered form allows the helmet to harmonically transduce a multi-frequency resonance just as Tibetan singing bowls. Among the many artifacts displaying fundamental geometric structures is a set of 12 dodecahedral magnetite crystals, each crystal having 12 sides (7.13, bottom). Magnetite is a mineral named for its magnetic properties, being naturally found in the frontal lobes of the brain,¹³ allowing the sensory perception of geomagnetic fields that is well noted in the animal kingdom, but largely absent from modern human populations without the benefit of kundalini activation.

La Maná’s remarkable ceramic figures are frequently adorned with wave-patterned snake forms, often double-headed (7.14, left), representing the electrical kundalini DNA activation process undergone at the site. Also found in abundance among these antediluvian remains are circular disc forms inscribed with sacred Sanskrit mandalas presenting the octagonal symmetry of Magnetic Resonance (7.14, right). While snakes are depicted throughout the large group of artifacts, reptilian humanoids are also represented.

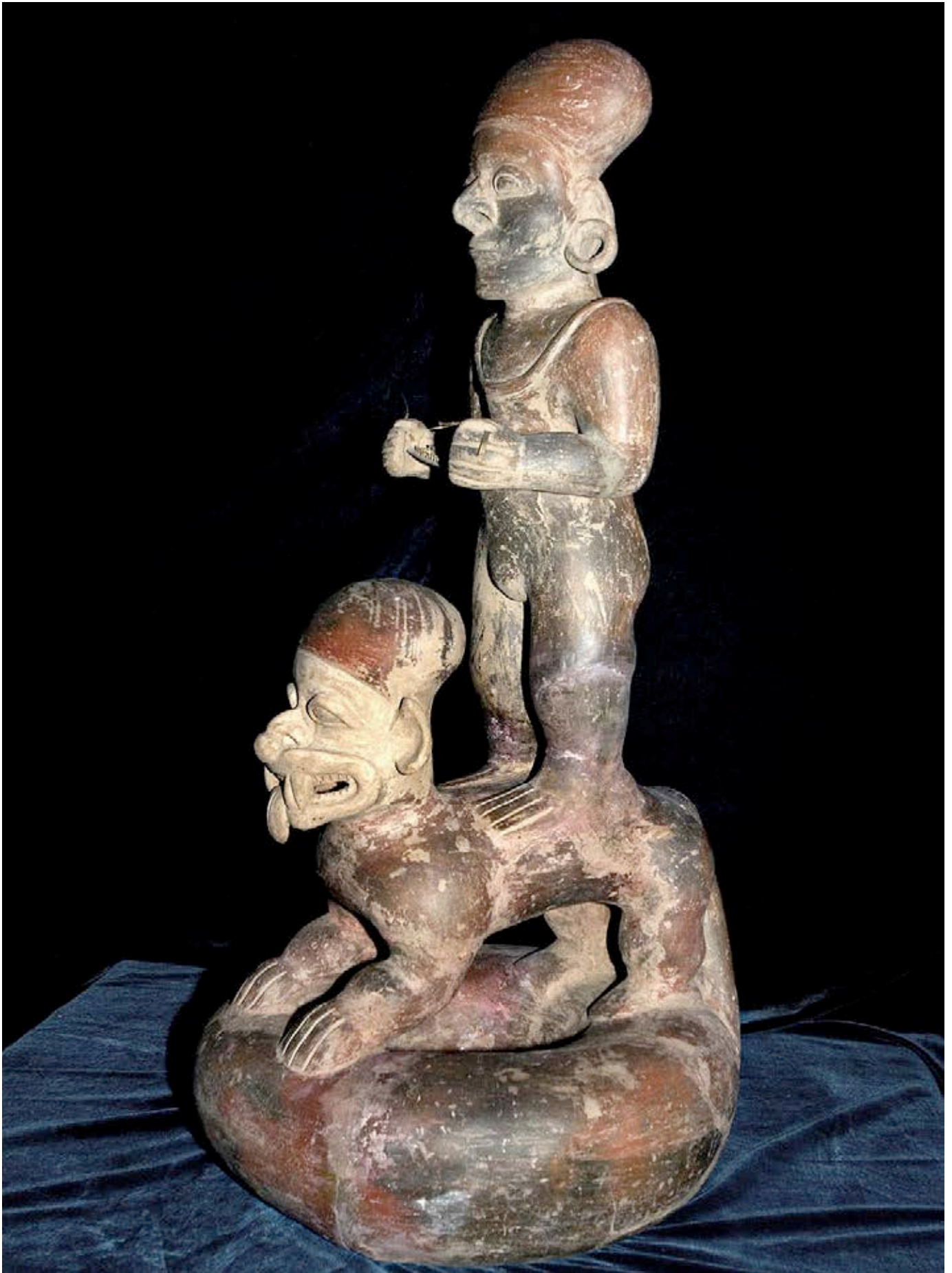



7.16. Fanged reptilian figure with scales, wearing a psychoacoustic helmet

Several of the figurative ceramic works from La Maná depict reptilian humanoid beings –their bodies covered with scales. The conspicuous reptilian facial characteristics are exactly repeated in each of several reptilian portraits: mouth agape, with fanged incisors and tongue hanging out, flared nostrils, prominent ears and scaly skin (7.16). These detailed ceramic Ecuadorian representations are also consistent with the reptilians depicted among South Africa’s stone Nomoli figures and among the Sanxingdui bronzes of China (5.15-5.15, pages 107-108). Virtually identical portraits of these demonic-looking serpentine humanoids are also prominent in the ceramics of the Ubaid culture of Mesopotamia. At La Maná, these humanoids are depicted using the same psychoacoustic helmets as worn by all of the human figures, suggesting a commonly shared technology between the two species, rather than one species being subordinate to another. One ceramic masterpiece from La Maná presents a human figure standing on the back of a prostrate reptilian figure (7.15). The human figure holds an intricate loom made of small interwoven gold and silver wires.

That particular sculpture is the largest of the masterworks from the La Maná cache and explicitly describes an adversarial relationship between the reptilian and human species, showing the human being to have subdued the reptilian through the use of celestial waters and the process of bioelectric kundalini activation. This interpretation of the sculptural imagery is consistent with the statements in the Egyptian Pyramid Texts that proclaim the Great Pyramid as: “House the rightness of whose howling the Great-Ones-Who-See-and-Orbit bring down to rest.”¹⁴ Are these orbiting extraterrestrials the reptilian beings serially depicted by the Atlantean world culture? As the pyramids and their celestial waters are today unused by terrestrial human society, one might symbolically reverse the positions of the sculpted figures –with the subordinated human being on the ground and the reptilian figure standing on his back. Humanity had fallen into dissonance.

Fear manifests in the body as a tightening of the DNA helix that results in a decrease in its electrical conductivity,¹⁵ as symbolized by the helical crown of the reptilians. Atlantean kundalini DNA activation processes employ heart beating and alternating electric currents transmitted through nano-gold and silver to unwind the DNA into a perfectly straight ladder that affects an enhanced conductivity (6.8, page 102). Thus, the pyramids function as a psychoacoustic defense against negative extraterrestrial influences.



7.17. Ceramic reptilian figure with psychoacoustic hemlet (center); and an intricate copper oculate figure, bird and frog

The growing human awareness of extraterrestrial quantum realities proceeds in step with our technological advancement, by which we have rediscovered the circular nature of time and space and our unlimited powers of consciousness that allow transcendence. Humanity stands on the threshold of attaining awareness of the place of Earth humanity within a broader context of the abundance of all types of extraterrestrial cosmic intelligences; beings of both light and darkness; benevolent and malevolent; physical, parapsychical and aphysical. Ancient extraterrestrial interactions recorded all over the world in Atlantean stone and ceramic masterworks invariably depict the same few humanoid species that are also reported by contemporary 'UFO' or 'alien' encounters –very tall reptilian humanoids with scaly skin and large eyes appear again and again in association with small, dwarf-like oculate beings. Giant humanoids have also been reported by 'abductees' and also frequently depicted throughout history in megalithic art and mythology, *fourth-density* beings inhabiting hydrino plasma realms such as those generated within the pyramid chambers. Terrestrial humanity was subjected to a *crash in the network*.

The collective consciousness of terrestrial humanity once induced by the function of the infrasound pyramid network was lost during the cataclysmic destruction of the Great Deluge, leaving humanity in a fragmented state of consciousness –without the collective defense of the shared awareness provided by biorhythmic synchrony. The ensuing millennia of human activity and learning has achieved the reassembly of our ancient Sanskrit cultural knowledge from widely strewn and fragmented antediluvian records on all continents of the world. The kundalini activation process that has lain dormant in the human unconscious is now being reawakened by cosmic influences that are naturally increasing the resonance of the sun and all of the solar system's planets.

This increasing planetary resonance is not only regenerating the capacity of collective human memory but also stimulating the upwelling forces that produce sacred water springs at various locations. Much to the surprise of the various La Maná landowners, the volume of water being produced by electrum springs on their land was increasing steadily since they had first used them. The increasing levels of Earth resonance can clearly be heard on the slopes of the sacred mountains, which I observed for myself as a deep humming felt every time I visited, being more distinguishable during the night hours. The infrasound resonance drives the solid-state sandstone water systems that produce a purified electrum colloid by ancient Sanskrit design. The process of bioelectrification and HHO plasma generation were both enabled by the electrum content of this rare water that is an artificial product of the ancient ingenuity of Aztlan.

The celestial waters of La Maná are not unique, however. Other ancient Sanskrit sacred sites are known for their curative waters throughout the world, the special knowledge of which has been preserved in the local indigenous traditions. In the cloud forests of northern Peru is an extensive subterranean system named for the curative potency of its underground rivers: *Iyacyecuj*, a Quechua name meaning 'enchanted waters.'¹⁶ Once a prominent habitation site of the ancient Chachapoyas culture, Iyacyecuj Cave (6.07°S 77.87°W) is 7,569 miles from Giza, Egypt, which is 30.4% of the Earth's mean circumference. Golden celestial water springs are also generating significant attention in Tlacote, Mexico, where the ancient manuscripts of the Chichimec culture have preserved the cultural knowledge of the site's curative forces.¹⁷ Tlacote (20.36°N 100.08°W) is 7,709 miles or 30.9% of the Earth's circumference from the Orion pyramids at Giza. These distance relationships precisely reflect the golden proportion, as calculated by using the Fibonacci sequence (F# 138), confirming the sacred alignments of these Sanskrit sites as shared by the La Maná celestial springs. Many more such cave sites exist.

The thorough corroboration of extensive physical remains reforms our understanding of the complex teachings of ancient oral traditions as the basic transmission of highly technical scientific data that was lost to written history in the downfall of the Atlantean Sanskrit civilization. Widely shared cultural legends of *the great flood*, *the fountain of youth* and an *ancient race of giants* are now being proven as scientific fact on the ground in Ecuador, Mexico, Malta and at dozens of other ancient sacred sites in alignment with the Orion infrasound pyramid network. Abundant collections of Atlantean ceramic and stone tablets to be deciphered using Schildmann's key reveal complex Sanskrit cosmological teachings. The concepts of tri-frequency acoustic resonance and the 30 resonances are attributed to Jupiter, pictured as a square and represented by prime number 7, for its vortical resonance pattern. Jupiter's name among the Nahuatl-speaking Mesoamerican cultures is *Tezcatlipoca*, meaning 'Smoking Mirror,'¹⁸ as its vortical resonance patterns mirror Earth's infrasound resonance mandala pattern: *the square within the circle*.

The geometric decoding of the psychoacoustic Sanskrit mandala provides the structural formulation of the wireless infrasound pyramid network shut down by the Great Deluge inundation of *heavy water* from Mars, destroying the Atlantean civilization. Many thousands of Sanskrit artifacts, temples, megaliths and pyramids attest to the advanced psychoacoustic technologies of an intercontinental culture that mastered the forces of gravity and consciousness by the transdimensional use of fourth-density hydrino plasma.

The true cosmic nature of the human being is becoming unveiled at the present time. The synthesis of quantum physics with infrasound DNA activation and the rediscovery of HHO plasma produced from water, a fuel found in abundance throughout the cosmos, informs a worldwide return to the ancient wisdom of spiritual metabolism enabling vast lifespans. The rejuvenating radiations of infrared and ultraviolet light released from atomic hydrogen fuels the bioelectric metabolism of the human body as gold and silver nanoparticles within each cell scatter pulses of red light in the strong electromagnetic fields of the pyramids, greatly extending the human lifespan while engendering group synesthesia. Humanity proceeds toward the threshold of a collective reawakening to the holographic capacity of consciousness under the guidance of the indigenous Elders, whose many penetrating voices rise as one:

Through this initiation they will be able to see the luminosity of the Great Spirit. When this spiritual initiation is completed in the house of Hunab K'u in heaven, the spirit of each initiate will be illumined. Then, it will return to Earth to awaken the body and take it to the pyramids. Chichen Itza, Uxmal, K'aba, Etnah, Palenque, all of these sacred Mayan centers have a specific function in every part of the body to awaken the 7 powers contained in it.

Only through the solar initiation can the sleeping body of mankind be awakened. The reincarnated teachers of the new age of Aquarius implore for the sacred human race to awaken, so that in this way it can fulfill its sacred destiny, which is to be the true sons and daughters of the cosmic light. The time of knowledge approaches, the light in the center of the pyramidal house of Hunab K'u will flash like lightning that will pierce through the shadows that envelop the human race. Let us prepare to receive the light of knowledge that comes from Hunab K'u and transcend into the memory of the creator and become beings of eternal luminosity.¹⁹

References

- ¹ Shön G (2003) '*Splend'Or Goldwater: Water Oscillation Photography*' AquaSplendor.at, online · <http://www.aquasplendor.at/engl/index2.html>
- ² Vyasa K, tr. Prabhupâda B (1977) 'Description of Jambudvîpa' *Srimad Bhagavatam*, Canto 5, ch.16, online · <http://www.srimadbhagavatam.org/canto5/Canto5-Sanskrit/chapter16.html>
- ³ -- (2007) '*Man Claims Skin Treatment Turned Face Permanent Blue*' Fox News, December 20, · <http://www.foxnews.com/story/0,2933,317564,00.html>
- ⁴ Elechiguerra JL, Burt J, Morones J, Camacho-Bragado A, Gao X, Lara H, Yacaman MJ (2005) 'Interaction of Silver Nanoparticles with HIV-1' *Journal of Nanobiotechnology* 3:6, online · <http://www.jnanobiotechnology.com/content/3/1/6>
- ⁵ Belkin M, Snezhko A, Aranson IS, Kwok W-K (2007) '*Magnetic Snakes Control Fluids, Gravity-Defying Droplets, and Solving a Dragonfly Mystery*' American Physical Society News, online · http://www.eurekalert.org/pub_releases/2007-09/aps-msc092407.php
- ⁶ Garitaonandia JS, Insausti M, Goikolea E, Suzuki M, Cashion JM, Kawamura N, Ohsawa H, Gil de Muro I, Suzuki K, Plazaola F, and Rojo T (2008) 'Chemically Induced Permanent Magnetism in Au, Ag, and Cu Nanoparticles: Localization of the Magnetism by Element Selective Techniques' *Nanoletters* 8, pp. 661-667
- ⁷ -- (2004) '*Splend'Or: Natural Spring Water*' online · <http://www.aguasplendor.com.ec/ingles/home.htm>
- ⁸ Kehr W (2005) '*The Bob Beck Protocol*' Independent Cancer Research Foundation, online · <http://www.cancertutor.com/Cancer02/BobBeck.html>
- ⁹ Lyman W, Kaali S (1996) '*Biocompatible Electric Current Attenuates HIV Infectivity*' online · <http://educate-yourself.org/cn/LymanKaalibiocompatibleHIV1996report18nov06.shtml>
- ¹⁰ -- (2003) '*About Hira Ratan Manek*' Solar Healing Center, online · <http://www.solarhealing.com/about.htm>
- ¹¹ Jenkins JM, Matz M (2004) '*Pyramid of Fire: Spiritual Ascent at the End of Time*' Bear & Company, p. 75
- ¹² Ibid, pp. 81-85
- ¹³ Kirshvink J, Kobayashi-Kirschvink A, Woodford B (1992) 'Magnetite Biomineralizations in the Human Brain' *Proceeds of the Natural Academy of Sciences* 89, pp. 7683-7687
- ¹⁴ Sitchin Z (1999) '*The Wars of Gods and Men: Book III of the Earth Chronicles*' Harper, online · http://www.bibliotecapleyades.net/sitchin/sitchinbooks03_03.htm
- ¹⁵ McCraty R, Atkinson M, Tomasino D (2003) '*Modulation of DNA by Heart-Focused Intention*' Institute of HeartMath, online · http://www.heartmath.org/templates/ihm/research/research-intuition/Modulation_of_DNA.pdf
- ¹⁶ -- (2007) 'Moment 600 Years Ago that Terror Came to the Mummies of the Amazon' *This Is London*, online · <http://www.humanresonance.org/iyacyecuj.html>
- ¹⁷ Quetza Sha GA (1996) '*The Manuscript of the Crystal Golden Water of Tlacote*' online · <http://www.humanresonance.org/tlacote.html>
- ¹⁸ Jenkins, op cit, p. 65
- ¹⁹ Men H, Yaxk'in AJ (2001) '*Mayan/Tibetan Prophecy*' online · <http://www.lightworkarticles.info/MayanProphecy/>