

# MUSIC AND DEEP MEMORY

SPECULATIONS IN ANCIENT MATHEMATICS, TUNINGS, AND TRADITIONS  
IN MEMORIAM ERNEST G. McCLAIN

1918 - 2014



ICONEA PUBLICATIONS LONDON

EDITED BY BRYAN CARR AND RICHARD DUMBRILL

# MUSIC AND DEEP MEMORY

*SPECULATIONS IN ANCIENT MATHEMATICS, TUNING, AND TRADITION  
IN MEMORIAM ERNEST G. McCLAIN.*



*Prima la musica e poi le parole*

ICONEA PUBLICATIONS LONDON

EDITED BY BRYAN CARR AND RICHARD DUMBRILL

*ERNEST G. McCLAIN GEDENKSCHRIFT*

© Copyright 2018 Bryan Carr and Richard Dumbrill  
All rights reserved under International and Pan-American Copyright Conventions.  
No part of this volume may be reproduced or transmitted in any form or by any means, electronic or mechanical,  
including photocopy, recording,  
or any information storage and retrieval system,  
without prior permission in writing from the publisher, ICONEA,  
The International Council of Near Eastern Archaeomusicology.  
All inquiries should be addressed to ICONEA  
[rdumbrill@iconea.org](mailto:rdumbrill@iconea.org)

ISBN 978-0-244-40558-8



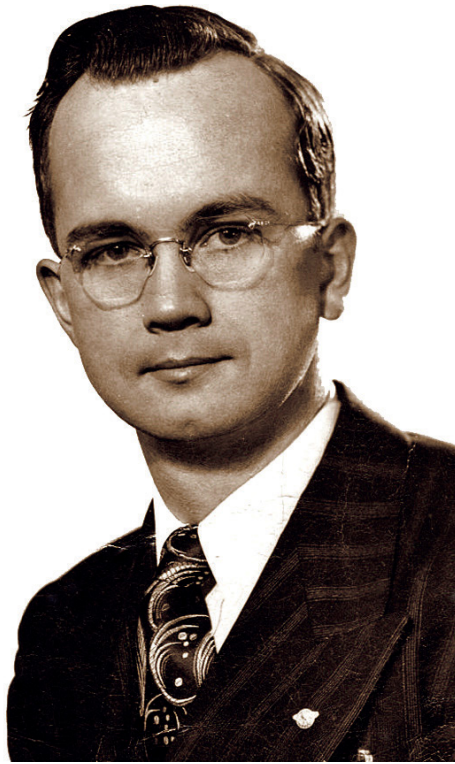

Late 1940s post war, with ruptured duck veteran pin



On the hiking trail, USA, 1970s



Sailing on Long Island Sound, 1960s



Hiking in the Alps, circa 1970.

## FOREWORD

Ernest McClain was one of the last great spiritual antediluvians. In a century during which scholarship tended overwhelmingly to regard the ancients with either scientific or deconstructive condescension, McClain simply settled down to patiently learn from them. Eschewing the wishful projection which would cast them in the image of a lost golden age, or a defensive antiquarianism which retreated into museum exhibits, McClain discovered the ancients continuing to speak -- or more precisely, to sing -- in the musical heritage of the whole human race. Listening to this unbroken voice, he eventually attuned himself to it so well he became, himself, the living embodiment of a mode of thought which one might have guessed had gone out of the world.

Beginning in the 1970s, starting with three extraordinarily dense books and continuing in a stream of essays and correspondence that lasted until the day of his death, McClain propounded a thesis, notable equally for its profundity and its simplicity, which read the archaic mythico-speculative inheritance of the West "from the Rg Veda to Plato" and beyond, as a musical cosmology. His work never gained anything like mainstream recognition (a fact which in later years he occasionally noted with bemused resignation), but for a small cadre of researchers, McClain is (as Joscelyn Godwin called him), "one of the most original and ingenious researchers of our time."

McClain's work was concentrated upon recouping the heritage of the ancient world, but he had more proximate sources in classical European culture. He was pointed to his method and to his important conclusions by three great friends. McClain always insisted that his work had been inspired and encouraged, in a manner far from casual, by his relationships with Hugo Kauder, Ernst Levy and Siegmund Levarie. Jewish refugees who had fled just ahead of Hitler's expansionism, they were also representatives of a musical and cultural milieu that had grown up in Europe continuously for centuries -- the heritage of folk music, Church psalmody, carmina burana; of Troubadors, Renaissance polyphony, Baroque innovations; of the evolution and cross-fertilization of Western music from the Classical era through the Romantics to the upheavals of the early 20th century. His close friendship with these men -- composers, performers, and scholars of high order -- was why, as a clarinetist trained in the Western classical repertoire, McClain was also sensitive to a Pythagorean heritage he eventually came to believe derived from the Neolithic age, via Egypt and Sumer -- and yet reaching all the way to us. This is important to emphasize, not simply in the interests of giving due credit, but because McClain frequently puzzled interlocutors by claiming that his work had a serious contemporary significance, and was not meant merely as a divertimento of footnotes.

Each of McClain's books -- *The Myth of Invariance*, *The Pythagorean Plato*, and *Meditations through the Quran* -- is a set of closely-argued excursions through a body of literature as if through an underground mine, looking for the telltale glint of something sparkling in the walls. That sparkle is number, and McClain demonstrated over and over that numbers are not scattered randomly throughout ancient texts. There is a preponderance of multiples of very low primes -- notably 2, 3, and 5; and very often, when a number that cannot be so reduced does occur (say, 37), looking to the context with the small primes in mind will yield a plausible rationale. The books have been noted for the density of their presentation.

("Obscure," "hard to understand," "inaccessible," are terms that come up in the (positive!) reader reviews online.) This challenge to readers is only partly due to the mathematics. More challenging is the fact that once McClain has a numerical trope established, he frequently runs with it, employing it just as the ancients (he held) did: as an extremely abbreviated figure of thought, which could be adapted to many different situations. And yet, he insisted repeatedly, the mathematics involved was itself not difficult. "A child can learn it," he claimed, and he implied moreover that in the era of the pocket calculator, no one, not even the math-averse, had any excuse. (As of this writing, all three of McClain's books are available in pdf from his website, [www.ernestmclain.net](http://www.ernestmclain.net), as are numerous essays. The shortest, most accessible, and least tendentious introduction to McClain's basic insights, however, may be the third and fourth chapters of Jay Kappraff's excellent popular mathematics book *Beyond Measure*.)

Serious engagement with McClain's work cannot help but alter one's apprehension of the whole apparent shape of ancient literature -- not least, the Platonic dialogues. My own experience is probably not too aberrant in this respect. For years I had known that I did not know how to read Plato. The stupid caricature of the body-denier, the philosopher who invented "another world" since "this" one was so changeable and disappointing (and, let's not forget, who "banished the poets"!), had always rang false -- a whipping-philosopher dragged out whenever we needed to blame someone for "essentialism." But although I could "smell" that this travesty was simply wrong, I did not know what to replace it with. There was obviously a tremendous amount going on between the lines in Plato that was going right over my head. No doubt much of this was due to the fact that it was written in 2,300-year-old Greek. And yet, Plato was so obviously concerned to transcend the particular, to reach beyond the limitations of a given setting -- not to deny them, but to refuse to be ruled by them. The limitations of a particular language were real, but they could not be dispositive. There must be a way in -- but where was it?

The Pythagorean Plato pointed out that the way was right where we had always known it was. The door to the Academy famously had on its welcome mat the phrase, *Some Geometry Required* (loosely translated). "Platonism" was expressly characterized by its coupling to the mathematical truth-condition. But however much commentators might acknowledge this at a kind of high-altitude level, the actual mathematics that occurs in the dialogues is very frequently ignored. (One stark example of this is found in the 1947 translation of the *Republic* by F.M. Cornford, in which Cornford permitted himself to omit entirely Plato's "extremely obscure" account (at 8.546b) of the so-called ruling or nuptial number, and also to "simplify" the text (at 9.587b) concerning the number of the Tyrant. Even when scholars do not give themselves such free rein, they very often let the mathematics pass by without much comment.)

McClain himself did find the clues in some commentary, including some very old commentary -- above all, Albert von Thimus, to whom he was pointed by Kauder, Levy, and Levarie; but also James Adam, Thomas Taylor, Plutarch, Proclus, Aristotle. Really, though, we might have guessed, for it is obvious once you think of it: Plato's mathematics is musical -- not accidentally, but essentially so. McClain understood the stakes of this interpretation to reach far beyond the exegetical:

*From Philolaus in the fifth century BC, through Plato and Aristoxenus in the fourth, and down to Ptolemy in the second century AD and Aristides in the third or fourth, Greek acoustical theorists moved confidently between two modes of expression: the absolutely precise and the conveniently approximate. ... There is an urgent need for a review of all these ancient materials, not simply for their intrinsic interest to musicians and historians of science, but for their wider relevance to the philosophical foundations of Western culture.*

*(The Pythagorean Plato, p.162)*

Indeed, (though this is perhaps not quite so obvious), this tradition is itself part of a great underground current of musico-mythical cosmology, which McClain worked very hard to unbury, stretching back to the Vedas (and likely before) and forward at least as late as the Quran. The most obvious “fossil record” of this tradition is the recurrence, not just of very specific numbers -- numbers which are usually multiples only of very small primes (mostly not higher than 7) -- in cosmological and visionary contexts, but of various sets of numbers which can be seen to “go together,” in a way that indicates that writers knew the provenance of the numbers, or at least that certain numbers called for certain other numbers, even when the surface meaning of the text has nothing overly to do with music -- aside from, say, the mention of a number of harpists or trumpeters attending the celestial court.

All throughout a largely misunderstood (when not ignored) career of four decades, McClain never tired of insisting upon the tremendous import of this project. He himself declined to write philosophy in any but the most occasional or offhand modes -- he was unpacking a prelude to philosophy, he said. (His friend and correspondent the Aristotelian philosopher John Holthouse once opined to me that “Ernest is a philosopher, but would rather die than admit it.”) It was, I came to see, not just that the numbers were a sort of scaffolding for a widely various but shared cultural background. The numbers were symptomatic of something else. They were features of a whole way of looking at, and being in, the world -- not an artificially schematized worldview parsed out in multiples of 2, 3, and 5, but a world in which the “metaphor” of cosmic harmony came perfectly naturally, and indeed was no metaphor. (Indeed, the phrase “cosmic harmony” may make us cringe in reaction to Newagey overtones, but did no such thing for the ancients).

In saying this much, I’ve already gone beyond what McClain himself explicitly argued. Whatever the range of associations he allowed himself, he nonetheless held himself to a strictly empirical program. His numbers were all there on the surface of the text itself, or in a very few cases, easily derivable from those that were. No one ever disputed this. It was the rationale he deduced that earned him occasional rebuke and eventually either polite disregard or sometimes misapprehending fandom. Early on, Gilbert Ryle set the tone. “Plato would never,” he informed McClain, “have planted all that musicology for you to find.” To which one rejoinder must surely be, well then, how is one to account for the numbers, the very specific numbers, in (for example) Plato’s texts? The Tyrant is held, in the Republic, to be exactly 729 times less fortunate than the good ruler. Not “about 700,” not 730. There are exactly thirty-seven guardians of the city Magnesia in the Laws, a city which Plato repeatedly insists will be composed of 5,040 citizens.

McClain’s conclusion was not that Plato really “supposed that the well-being of the city depended almost as much on the number 5040 as on justice and moderation,” (as Jowett remarks). Nor did he believe, as Ryle feared, that Plato had played a kind of nudge-wink game of find-the-tuning-theory with his readers for the fun of a few initiates. It was, rather, that Plato’s exposition of justice and moderation found a completely natural expression in terms that privileged this musical and numerical grammar, and did not find it distracting. Far from being some private diversion on the part of Plato, it was an inherited vocabulary shared across a wide spectrum of wisdom texts descending from a common tradition, which lasted in oral culture even until the early strata of the Quranic tradition.



Even among his disciples, there has been significant breadth of opinion about the nature of the nature of the importance of McClain's work, and much of this variation is occasioned by this wide-net approach which drew in a vast range of background, beginning with the Rg Veda (on which his friend Antonio de Nicholas had written a book, *Four Dimensional Man*, whose importance for his own work -- and for his serious students -- McClain frequently emphasized). Some readers seized upon McClain as grist for anti-modern contentions, trying to recover an ostensibly lost tradition capable of producing "real magic." Some imagined that McClain's numbers would provide something like the resonant frequencies of the soul, a means for opening the crown chakra by just the right solfeggio. Others were intrigued enough by the musical ramifications to build instruments aligned to various tunings derived from McClain's work. And some were content to multiply contexts in which McClain's tonal harmonics could be plausibly applied, but without raising larger questions as to why.

My own interpretation is, I am sure, no less idiosyncratic. Tuning a musical instrument is a continual practical exercise in letting good enough be good enough; in making one adjustment here and then a counter-adjustment there. The great paradox is that this became the flowering seedbed of an effort to understand the whole. Because there are incommensurables built into the theory, the theory becomes a self-referential exercise in showing how theory itself fails to account for the whole, but in a way that weirdly manages to show the whole as needing no accounting. Approximation and precision become the warp and woof of cosmology and indeed of askesis. (And, I will add, Plato is especially significant in this account because he comes at an historical moment when, under the inexorable influence of writing, the complete naturalness of this way of thinking is no longer so evident, but has become itself a problem.)

McClain kept a respectful engagement with all contacts and the proclaimers of all interpretations, never disdaining them; often profiting from their suggestions even while insisting that what he was talking about was not "secret" and never had been, in any para-Masonic sense. It was all out on the surface of the texts; you just had to learn to think like the authors. (Here again, the fact that his method grew out of continuity with the whole tradition of Western music and culture, helps one to gain purchase on this point.) He had warm and deep correspondence with giants like John Bremer and Seyyed Hossein Nasr, and also with young and eager readers who had discovered his books or his website on their own and sometimes had no credentials aside from being intellectually alive and not risk-averse. In the last decade of McClain's life, many of these exchanges occurred under the auspices of the online BIBAL forum, moderated by Duane Christensen, a scholar of the Old and New Testaments and himself an embattled proponent and architect of a structural hermeneutic which read the Hebrew and Christian scriptures alike as very precisely (and numerically) engineered. An extremely accommodating moderator and an enthusiastic partner in dialogue, as well as a tireless pastor (he and his wife Martha carried out a prison ministry for years), Christensen not only fostered a conversation among a number of very diverse interlocutors -- a conversation which was very invigorating for McClain and those who encountered him there -- but also did much himself to advocate for McClain's work, including using it as an important aspect of his theoretical basis in his commentary on the prophet Nahum in his new edition for the Anchor Bible series.

Much encouraged by this late-blooming attention, McClain evinced a palpable optimism, continuing to believe that a breakthrough insight might well surprise him and force revision of everything he'd written. I've never known anyone with more intellectual gumption. On BIBAL, he relished sharing and sparring with friends, throwing out variations on the book of Ezekiel one day, a Sufi poem the next, always ready to make mistakes in public, and insisting both that no one believe him "until you must," and that whatever your own work was, you did it "your way." (I remember a titanic debate between him and David Crookes over the pertinence of gematria, which reminded me at the time of Nabokov and Wilson clashing in the pages of the New York Review of Books: the rest of us went scurrying. Well, I did. McClain said at the time, "Two musicians couldn't agree more perfectly to disagree profoundly! Ain't that usually the way with our breed?" Crookes repaid the compliment when in his remarkable book *The Lord Shall Count* he thanked McClain "for his instruction, for his encouragement, and above all for his regular bursts of gunfire.")

An invaluable -- and now keenly missed -- friend and mentor, a never-flagging enthusiast of "adventures in ideas" (a Whiteheadian phrase he loved), McClain took with great seriousness the ancients' love of play and their easily-shifting referents. I slowly came to see that he had indeed learned to think like them. The oft-remarked density of his books is a function not of obscurity of his subject-matter, but of the extreme compression with which his mind was accustomed to move, the way he could pack whole clusters of "contradictory meaning" into root-metaphors. To the outsider this is bewildering, and looks like either eye-glazing calculus or word salad. But after spending enough time with him, one came to see that the details, while ready to open up if you did the work (which in every case turned out to be almost as easy as he promised), were actually part of the "precision" that took its accustomed place within approximation's relaxed mode. "Agreement" and "disagreement" are thus themselves in a continuous dialectic with one another, in theory as in practice -- which means that the effort to understand becomes itself an instance of what is to be understood. The musician recapitulates the music. In short, McClain taught us that the law was always already included within grace.

Bryan Carr



## INTRODUCTION: MUSIC AND DEEP MEMORY *SPECULATIONS IN MATHEMATICS, TUNING, AND TRADITION*

### IN MEMORIAM ERNEST G. McCLAIN

Ernest McClain's work is an enthusiastic and painstaking excavation of tradition. McClain always maintained that what he was "uncovering" had in an important sense never been hidden; the numbers were an inevitable side-effect and index of the phenomenon of human music, and their symbolic and "mystical" import remained recoverable with due humility and patience. He was, eventually, philosophical about his relative marginalization in Academe, and he knew he had produced work which was a taxonomical challenge to librarians and scholars. Was it history? Music theory? Philosophy? Despite its empirical foundations, McClain's work is speculative insofar as it hypothesizes certain techniques which cannot be verified to have been used anciently -- though it makes sense to think they were used -- and in making use of parallels which are broadly cross-cultural (anciently) and cross-disciplinary (today). McClain was sometimes cavalier about what explanation(s) should be entertained for these parallels. Diffusion? Structural similarities? Archetypal psychology? Mystical insight? What he insisted upon was the need to be arithmetically accurate, musically realistic, hermeneutically responsible, and speculatively adventurous.

"Music" in our title, we take it, is self-evidently apposite. "Deep Memory" pertains to this tradition -- both intentionally and unconsciously maintained and recorded -- which McClain felt (though he could not prove) was continuous from the Yangtze to the Thames and from Gilgamesh to the Quran (his correspondents sometimes pressed it as early as Avebury or Lascaux -- to say nothing of Atlantis! -- and as late as Snorri, or Chaucer, or Bacon). The essays in this volume explore this tradition in some of its historical, mathematical, musical, architectural, and philosophical aspects. These essays are acts of homage and affection, attempts to carry forward in the spirit of living enquiry which McClain exemplified. Their topics are perhaps more various than is typical for a collection of this sort; but they belong together not merely accidentally as associations of a particular scholarly career, but essentially as different dimensions of a coherent research program of extensive relevance. However, it bears mentioning that perhaps not all of them would have met with McClain's unreserved approval. He would have applauded their seriousness and their daring; he might well have taken issue with their method or conclusions. Every essay is testimony to the unreserved encouragement of spirit he offered during his life; his willingness to critique -- and the way he did so -- was part of that generosity.

McClain was deeply concerned with how human beings, in their musical and mathematical ingenuity, devised ways of developing and exploring variation under different degrees of constraint. Such constraints are many: the resistance and different behaviors of materials, the limited capacity of the human ear and voice; the fact that all geometrical depictions are approximations of idealities. Jean Le

Mée’s paper, “The Challenge of Abul Wafa,” treats one particular set of constraints: the requirement, imposed by mathematical discipline, to construct geometrical figures (in this case, the five Platonic solids) with compass and straightedge alone. This constraint is made more rigid by Abul Wafa by restricting the compass setting to a single width: the so-called “fixed” or “rusty” compass. Le Mée points out not only that this challenge can (with due intrepidity) be met, but gives detailed instructions for meeting it. (It remains an open question whether Le Mée’s solution is precisely the one Abul Wafa would have used; it must, in any case, be close.) This very specific problem finds its place in a very wide and lengthy tradition of geometrical and practical inquiry, which forms the background to Leon Crickmore’s contribution, “Castlerigg: Stone or Tone Circle?” Crickmore offers an interpretation of the Castlerigg, a neolithic monument situated in the northwest of England and remarkable for its preservation and its beautiful site. Crickmore reads Castlerigg in terms of both astronomical and musicological systems, seeing it not just as significantly oriented to celestial events, but as a large-scale model of the octave. The background Crickmore assumes ranges from the elaborate diagrams from the 18th-century papers of John Byrom, through Greek tuning systems, to Babylonian geometrical problems (for the interpretation of which he makes some specific suggestions); and he concludes with a suggestion that, in “playing” with the correspondences, one may generate new insights, “even contradictory” ones, poetically resonant even if not verifiable. This may seem a tremendous amount to include in a single glance, but the perhaps bewildering range of materials is underlain by an expressly musical rationale. Jay Kappraff’s paper “Ancient Harmonic Law” goes into great detail explicating this. Kappraff, who has previously devoted several chapters to McClain in his books *Beyond Measure* and *Connections*, and who collaborated with McClain extensively, is perhaps uniquely qualified to offer such exegesis. In his paper, Kappraff unpacks McClain’s close reading of Nichomachus and Boethius. He demonstrates that, however broad the metaphorical applications, McClain’s mathematics was always rigorously grounded in concrete and demonstrable musical proportions, with which these ancient authors were familiar and comfortable.

The number seven looms large in many of these considerations, because these proportions generate a scale of seven notes, widely associated in antiquity with the seven classical “planets.” Seven is also linked to one of the earliest geometrical problems which is unsolvable with compass and unmarked straightedge alone: the drawing of a heptagon. Sarah Reichart and Vivian Ramalingam show how this challenge was navigated by convenient approximations in several striking monuments of sacred architecture. They provide a rich account of the histories and implicit symbolisms of these sites, striking in their cross-cultural resonance. Their survey covers three buildings, in France, the Netherlands, and Germany (and mentions several other sites of interest along the way), and also treats the extensive symbolism of the number seven rooted in myth, scripture, and numerology. Such architectural (and acoustical) projects are of course not carried out for the sake of overcoming a geometrical Thou Shalt Not; they occur in cultural milieus which provide cosmological and spiritual grounding for those who participate in them. In “Pattern of Settlements 1-9,” Petur Halldórsson shows how far back (temporally), and how widely diffused (geographically), such cosmologico-architectural impulse may be found. Halldórsson’s approach is rooted in the work of Icelandic scholar Einar Pálsson, but his survey extends beyond the Icelandic context that Pálsson mostly stayed within. Considering sites in Iceland, Denmark, France, Greece, Italy, and Egypt, Halldórsson contends that one may discern in each case a method of plotting human settlements with respect to significant landscape features in such a way as to align with important recurrent astronomical events. This practical dialogue between human artifice, terrestrial environment, and celestial pattern, is of the essence for understanding the application of musical grammar McClain

read. Anne Bulckens' paper "The Metonic Cycle and the Parthenon" argues that a similar (not at all identical) encoding of astronomical and musical proportions was used by the architects and builders of the Athenian Parthenon. Bulckens' work includes an imaginative but plausible method by which the lengths of the year could have been determined with considerable precision, and her architectural claims are spelled out, in many cases, down to fractions of millimeters. Her reconstruction includes a highly ingenious (albeit speculative) system whereby various astronomical time-spans would have been represented not by lengths but by areas; a solution which is, as far as I know, unique in the literature.

As a sample of McClain's own work, "The Proportional System of the Parthenon" exemplifies the way he too experimentally applied this grammar to ancient sacred architecture. This paper, an earlier version of which built upon some of Bulckens' preliminary results, is a collaborative effort with Kappraff, who has also finished the paper and prepared it for publication. Kappraff and McClain show not merely how numerous measurements of the Parthenon are plausibly connected, via musical proportion, to the Vedic fire altars whose construction is described in the Shrauta Sutras. This chapter by Kappraff and McClain is accompanied by an appendix by Richard Heath, which relates their findings to broader disputes in the field of ancient metrology. Heath's larger contribution to this volume is "Ernest McClain's Musicological Interpretation of Ancient Texts," which is an application of McClain's method to the text of Genesis. A researcher whose work has focused upon ancient metrology and astronomy and the remarkable ways in which these intertwine with music to suggest a coherent ancient cosmology, Heath developed his website [HarmonicExplorer.com](http://HarmonicExplorer.com) (a tool which happily McClain was able to utilize during the last years of his life), in order to more readily unpack such resonances. Using graphics from this indispensable resource, Heath is able to show with considerable detail how an interplay of symbolic, narrative, and mathematical elements illustrates the way these aspects worked together in the minds of the authors and redactors of Hebrew scripture.

Such textual analysis, this time of Plato, is also the focus John Bremer's paper on "The Opening of Plato's *Polity*." It is an honor to include this contribution by John Bremer, who did not live to see its publication; his scholarship and his care for the real ends of education made him that rarity of rarities, a philosopher in the real sense: a lover of wisdom. (He always modestly shook his head at McClain's compliment that he was "the best Greek scholar I know," and preferred to remember what was said of Thomas Taylor: "that his opponents knew more Greek, but he knew more Plato.") Making the case that Plato gave extreme care to fine-grained micro-engineering of his texts, Bremer attends to the first eight words of this dialogue – "I went down yesterday to the Piraeus with Glaucon son of Ariston." From this hyper-focus, Bremer then gradually opens up the ramifications that arise when one takes seriously the possibility of such attention on the part of Plato as author. Bremer believed that these ramifications extended as far as the counts not just of lines or words, but of syllables, in Plato's texts; but he also always insisted upon remaining rooted in and oriented by the fundamental issues of philosophy: how one should live. (Forget these questions, Bremer said, and we may as well do crossword puzzles.)

Either in the case of the Bible, or in the case of the Platonic corpus, one is often struck by the question of whether such fine-structured engineering is historically or textually plausible; but also, why it would matter. Both Heath and Bremer show its plausibility, and moreover what such structuring could accomplish. But – granted that philosophy could take such pains – why should one attend to such a philosophy? The paper by Bryan Carr, "Ontology Inside-Out," is meant as an exploration and illustration

of what might now be at issue for such a musically-inflected cosmology — not anciently, but today. It asks this by way of a comparison between Aristides Quintilianus, the Neoplatonist musical theorist, and Quentin Meillassoux, a significant contemporary philosopher whose work aims to press as far as possible the implications of the mathematical, as opposed to the musical, reading of the cosmos following from the Copernican-Galilean revolution. The stakes of this philosophical contest, Carr argues, are high, and include the terms under which the Hellenic and the Biblical heritage of the West can fruitfully engage with each other. The following paper, by Babette Babich, can be regarded as one possible set of variations on the playing-out of these ramifications in the contemporary world. Babich's paper, "The Hallelujah Effect," is a kind of "retrospective preface" to her book by the same title, which had its origin in ongoing email correspondence with McClain in the last years of his life. A long and meandering excursion into the conditions of musical culture today, *The Hallelujah Effect* takes its title from the remarkable song "Hallelujah" by Leonard Cohen, one of the most-recorded songs in recent decades, and traces it through several versions, raising along the way far-flung questions about internet culture, advertising and ideology, and philosophy of music (with special attention to Nietzsche and Adorno). Those looking for the immediate connection with some of McClain's own concerns may wish to start with section III of the paper: "On Nietzsche's Greeks and Nietzsche's Beethoven."

So much, then, for allegations that McClain's contentions are implausible, or irrelevant. There remains, however, an oft-met difficulty about whether they are anachronistic. This is the question addressed by Pete Dello in his paper on "McClain's Matrices." Step by step, Dello shows that although it remains an open question whether it was utilized precisely in the form in which McClain presents it, it is plainly not anachronistic when compared with the mathematical and musical achievements of the Sumerians already in the third millennium BC. Dello gently insists that a musical scribe of the era, easily grasping McClain's method and point, would readily have recognized him as one of their own. The question of anachronism also informs the next paper, Richard Dumbrill's "Seven? Yes, but...," an extensive inquiry into the tuning systems that can be decoded — not uncontroversially — from Akkadian and Sumerian sources. Dumbrill gives an account of — and takes a strong position in — the polemics concerning reconstruction of the scale used in this ancient music: how many notes? Where was the root tone? How did the tuning proceed? And were the scales supposed to be ascending or descending? Over a long professional friendship, Dumbrill and McClain argued over the details of various such reconstructions; Dumbrill always insisting that the texts had to have the final word; McClain often shrugging that his mathematics made perfect symbolic sense, and that practical musicians were always entitled to ignore theoretical niceties in any case.

The questions of mediation between antiquity and today, between music and mathematics, between the Hebrew and the Greek (and Egyptian, Sumerian, Chinese!) heritage, and between the very specific and the extremely broad, remain the focus of the next chapter. Howard Barry Schatz argues, in "Through the Eyes of Plato," that McClain's findings may be fruitfully applied to — or perhaps, are themselves an application of — a spiritual technique that has its provenance in the foundational Kabbalistic document, the *Sepher Yetzirah*. Pointing out the essential continuity of McClain's work with that of Kauder, Levy, and Levarie, and that of the important and neglected Albert von Thimus, Schatz argues that these insights shed crucial light on comparative religious studies, the musical history of the West, and indeed on the eventual promise of a scientific theory of the whole universe in terms of string theory; most significantly, perhaps, he underscores their import for the contemporary possibilities in ecumenical dialogue and interreligious spiritual discipline.

In keeping not only with our intention to honor a significant scholar, but with the spirit in which his work unpacked the intertwining of the particular and the universal, many of our chapters include personal recollections of Ernest McClain by the authors. We conclude the volume as a whole with a moving memoir by Gerald M. Turchetto, who recounts in vivid terms both the philosophical stakes of McClain's project and the difficulties of understanding it oneself -- let alone of getting it a fair hearing. The (pseudo?-) Platonic *Epinomis* includes this prediction:

*To the man who pursues his studies in the proper way, all geometric constructions, all systems of numbers, all duly constituted melodic progressions, the single ordered scheme of all celestial revolutions, should disclose themselves, and disclose themselves they will, if, as I say, a man pursues his studies aright with his mind fixed on their single end. As such a man reflects he will receive the revelation of a single bond of natural interconnection between these problems. [Epinomis 991e>]*

This moment of insight bears comparison with account Turchetto gives of his own Eureka-moment during his lesson from McClain with the monochord: “By following his various placements of the triangular fret along the monochord and listening as he did so, the mathematics and the music finally merged in my experience. All the mathematical decisions that drive the music, and all the musical decisions that drive the mathematics, were brought home to me, along with the intense frustration of wanting to make them work together harmoniously without compromising the integrity of either. Good luck! That dilemma is at the core of it all.”

These essays are each attempts to wrestle with this dilemma. They all bear the marks of practice in the studio where learning is the fret, speculation the tuning peg, and the string is the human soul itself. Knowing the stakes, the poised tension between spirit and letter, Ernest McClain would surely have argued strenuously with (or against!) any number of contentions herein, even while insisting that his opponents stick to their guns. What is crucial is the rapport, in which argument and agon is but a single phase – albeit an essential one. Offered in a spirit of tribute and homage, these writings are given also as continuation of a great adventure in which each of us is tempered by every other.



Ernest and Augusta on their wedding in 1973







2010

ERNEST G. McCLAIN

(AUGUST 6, 1918, MASSILLON, OHIO - APRIL 25, 2014, WASHINGTON, DC)

## A BIBLIOGRAPHY

### BOOKS

- 1981 *Meditations through the Quran: Tonal Images in an Oral Culture*. Maine: Nicolas Hays.
- 1978 *The Pythagorean Plato: Prelude to the Song Itself*. Maine: Nicolas Hays.
- 1976 *The Myth of Invariance: The Origin of the Gods, Mathematics and Music from the Rg Veda to Plato*, ed. Patrick A. Heelan. Maine: Nicolas Hays. Reissued 1984.

### ARTICLES AND ESSAYS

- 20-- Children of Abraham. New appendix to the reprint of *The Myth of Invariance*.
- 2010 'A Sumerian Text in Quantified Archaeomusicology', *ICONEA* 2008. Dumbrill & Finkel eds., pp. 89-104.
- 2010 Musical Adventures in Ancient Mythology. *Pythagoras Foundation Newsletter*, 15.
- 2009 Children of Abraham. *Sophia: The Journal of Traditional Studies*, 15(1), 59-77.
- 2009 Egyptian Connections: Narmer Inscriptions as Sumerian Musicology. *ICONEA* 2009-2010, Dumbrill ed., 73-106.

- 2008 With Kappraff, J. The System of Proportions of the Parthenon: a Musically Inspired Architecture. In M. Habrel & O. Bodnar, *Shliakh do harmonii : mystetstvo + matematyka [The way to harmony : art + mathematics]* Lviv: L'vivs'ka natsional'na akademiia mystetstv. 203-20.
- 2005 with Kappraff, J.P., The System of Proportions of the Parthenon: a Musically Inspired Architecture. *Music In Art: International Journal For Music Iconography*, 30(1-2), 5-16.
- 2005 Harmonic Series as Universal Scientific Constant. [ernestmclain.net](http://ernestmclain.net)
- 2004 The Forgotten Harmonical Science of the Bible. *Epigraphic Society Occasional Papers*, 24, 150-69.
- 2002 A Priestly View of Bible Arithmetic: Deity's Regulative Aesthetic Activity within Davidic Musicology. In B. Babich, *Hermeneutic Philosophy of Science: Van Gogh's Eyes, and God: Essays in Honor of Patrick A. Heelan*. Dordrecht: Springer. 429-43.
- 1997 The Star of David as Jewish Harmonical Metaphor. *International Journal of Musicology*, 6, 25-49.
- 1994 With Levarie, S. Temple Tuning Systems. *International Journal Of Musicology*, 3, 22-30.
- 1994 Musical Theory and Ancient Cosmology. *The World And I*, 9(2), 370-391.
- 1992 Tonal calendars in ancient civilizations: Mesopotamian antecedents of Pythagorean Harmonics. *Proceedings Of The Symposium Of The Archaeology Of Music* Dec 7-10 1991.
- 1991 Music's Discipline of the Means: an interview with Ernest McClain. *Parabola*, 16(4). 85-9.
- 1988 Why Kauder? *MadAnima! A Chronicle Of Musical Catalogues*, 9(2), 5-6.
- 1987 Tonal Isomorphism in Plato and the I Ching: Brumbaugh as Cultural Anthropologist. In B. Hendley, *Plato, Time, and Education: Essays in Honor of Robert S. Brumbaugh*, Albany: SUNY. 131-52.
- 1987 Circle. In M. Eliade, *Encyclopedia of Religion*. New York: MacMillan.
- 1987 Geometry. In M. Eliade, *Encyclopedia of Religion*. New York: MacMillan.
- 1987 Comment on Vladimir Lefebvre's tonal automata. *Journal of Social and Biological Structures*, 10(2), 204-12.
- 1986 Comment on "The Structure of Ancient Wisdom", by Colin Renfrew. *Journal of Social and Biological Structures*, 9(1), 3-4.
- 1986 The ancient Chinese "calendrical" pitchpipes. *The Journal of the Acoustical Society of America*, 80(S1).
- 1985 Tonal Ontology: Comments on Piguet-Ansermet. *Journal of Social and Biological Structures*, 8(4), 363-5.

- 1985 The bronze chime bells of the Marquis of Zeng: Babylonian biophysics in Ancient China. *Journal Of Social And Biological Structures*, 8(2), 147-76.
- 1982 Structure in the Ancient Wisdom Literature: The Holy Mountain. *Journal of Social and Biological Structures*, 5(3), 233-48.
- 1980 Three for Aristotle: Three Theories of Music - Hans Kayser, Peter Hamel, Herbert Whone. *Parabola*, 5(2), 88-93.
- 1979 With Hung, M. S., Chinese Cyclic Tunings in Late Antiquity. *Ethnomusicology*, 23(2), 205.
- 1978 The Ka'Ba as Archetypal Ark. *Sophia Perennis: The Bulletin of the Imperial Iranian Academy Of Philosophy*, 4(1), 59-74.
- 1978 Thirty seven musical guardians in Plato's Laws. *Music and Man*, 2(3-4), 181-203.
- 1976 The Tyrant's Allegory. *Interdisciplina*, 1(3), 23-37.
- 1976 Review of Christos Toulis' translation of Theon of Smyrna: Mathematics Useful for Understanding Plato. *Parabola*, 4(4), 113-5.
- 1976 Our Musical Sabbath. *Jeevadhara: A Journal of Christian Interpretation*, 35, 418-28.
- 1975 A new look at Plato's Timaeus. *Music and Man*, 1(4), 341-60.
- 1975 The scroll and the cross. *Catgut Acoustical Society Newsletter*, 23.
- 1974 Musical "Marriages" in Plato's "Republic". *Journal of Music Theory*, 18(2), 242.
- 1973 Plato's Musical Cosmology. *Main Currents In Modern Thought*, 30(1), 34-42.
- 1970 Pythagorean Paper Folding: A Study in Tuning and Temperament. *The Mathematics Teacher*, 68(3), 233-7.
- 1949 With Clopton, R. W., Guamanian Songs. *The Journal of American Folklore*, 62(245), 217.

## COMMENTARY ON ERNEST McCLAIN'S WORKS

- 2013 Kappraff, J., Ancient Harmonic Law as a Generator of Cultural Metaphor. *Symmetry: Culture And Science*, 24(1-4), 391-419.
- 2011 Bremer, J. Plato, Pythagoras, and Stichometry. [instituteofphilosophy.org. http://instituteofphilosophy.org/plato/plato-pythagoras-and-stichometry-2/](http://instituteofphilosophy.org/plato/plato-pythagoras-and-stichometry-2/)

- 2010 Bremer, J. Plato, Pythagoras, and Stichometry. *Pythagoras Foundation Newsletter*, 15.
- 2009 Nambirajan, S., Gods of Sumeria symbolize Ancient Music of 22 Srutis. [Sumeriangods.blogspot.com](http://Sumeriangods.blogspot.com)
- 2004 Abraham, R., & Thompson, W., The Canon of Lespugue. *Epigraphic Society Occasional Papers*, 24, 170-93.
- 2004 Pont, G., Philosophy and Science of Music in Ancient Greece: Predecessors of Pythagoras and their Contribution. *Nexus Network Journal*, 6(1), 17-29.
- 1996 Nelson, C., The Universal Pattern and Its Correlation to Musical Harmony. [Spiritofra.com](http://www.spiritofra.com). <http://www.spiritofra.com/Sound.htm>
- 1989 Lefebvre, V., McClain's circle and Plato's harp. *Journal of Social And Biological Structures*, 12(1), 73-81.
- 1987 DeWoskin, K., Comment on 'The bronze chime bells of the Marquis of Zeng: Babylonian biophysics in Ancient China' by E. G. McClain. *Journal Of Social And Biological Structures*, 10(4), 329-41.
- 1984 Judge, A. Tonal patterns of Rg Veda poetry: Examples of Integrated, Multi-set Concept Schemes. [Laetusinpraesens.org](http://Laetusinpraesens.org). <https://www.laetusinpraesens.org/docs80s/84nsetsx/x07.php>
- 1980 Pont, G., Plato's musical numbers and the problem of incommensurability : a response to Ernest G. McClain. *New York: City University of New York Graduate School and University Center*.
- 1979 Purcell, F., Review of *The Myth of Invariance*. *Teachers College Record*, 80(3), 611-2.
- 1979 Konstan, D., Review of *The Myth of Invariance* and *The Pythagorean Plato*. *Isis*, 70(4), 599-600.
- 1979 Heelan, P., Music as basic metaphor and deep structure in Plato and in ancient cultures. *Journal Of Social And Biological Structures*, 2(4), 279-91.
- 1977 Wingate, F., The published writings of Ernest McClain through spring, 1976. (Mus.M). North Texas State University.
- 1978 Levarie, S., Review of *The Pythagorean Plato*. *The Musical Quarterly*, 64(3), 402-7.

## LECTURES AND PRESENTATIONS

Paper presented by Peter Blumsom 'Egyptian Connections: Narmer Inscriptions as Sumerian Musicology'. ICONEA 2009-2010: Proceedings of the International Conference of Near Eastern Archaeomusicology, held at the British Museum, 4-6 December 2008.

'Tuning Theory in the Second Millenium BC: Mesopotamian Myth and the 9-string Lyre'. 2002.

'The geometric interface between astronomy and music'. Boston seminar, 2000.

'Tonal Calendars in Ancient Civilizations: Mesopotamian Antecedents of Pythagorean Harmonics'. Symposium of The Archaeology of Music. Cambridge University Dec. 7-10, 1991.

'New possibilities in Han pitchpipes', and 'Disabling assumptions in the study of Han science: a musicological reorientation'. 5<sup>th</sup> International Conference on the History of Science in China (ICHSC) UC San Diego August 5-10, 1988. also 'The Han Calendrical Pitchpipes'.

Five Lectures at SUNY Stony Brook, July 15-July 28, 1982.

'Homage to Pythagoras'. Lindisfarne Corresponding Member's Conference, August 23-29, 1981, Colorado.

'A Reply to Professor Larson from the Aspect of Musicology and Number Theory'. presented at The Institute for Advanced Studies of World Religions, SUNY Stony Brook, April 24, 25, 1981.

'Musical Calendars of Ancient Civilizations'. Society for the Investigation of Recurring Events, April 15, 1981, New Jersey.

'Music and Mythology: Tibetan Variation'. Symposium: Sounds of the Sacred Mountains: Music and Myth of Tibet. July 2, 1980. American Museum of Natural History.

'Musical Theory in Plato's Republic'. SUNY Stony Brook Music Department, April 30, 1980.

'Plato's Mathematical Universum: the Harmonical Origins of Political Science'. Ancient Wisdom Symposium, January 1980.

'Musical Calendars and Sumerian Origins'. MIT Seminar, October 31, 1979.

'Aristotle as Musicologist'. Brooklyn College Seminar in Musicology, October 2, 1979 (?).

'Plato, Mathematics and Music'. American Society for Aesthetics, Rutgers University, October 28, 1978.

'The Origin of the Gods, Mathematics, and Music'. Haverford College, March 30, 1978.

'Music and the Calendar in India and Other Ancient Civilizations'. ISCSC Colloquium, April 1, 1976.

'The Scroll and the Cross'. The Catgut Acoustical Society Newsletter, Number 23, 1975.

'The Tone World: Limits, Order'. Brooklyn College Mathematics Club Meeting, (?).

## OTHER ARTICLES

'The Creation of the World: a View from Alexandria in the 1st Century A.D.'

'Chinese Tonal Cosmology'. Unpublished (?)

1985 'On the Discovery of Interval Ratios'. Unpublished (?)

'The Return of Odysseus: Essays in Honor of Eva Brann'. Unpublished (?)

'On the possible origins of the 22 sruti system of Hindu musicology'. Unpublished (?)

'The Nine-String Akkadian Lyre of Kilmer, Cocker, and Brown'. Unpublished (?)

## ACKNOWLEDGMENTS

Deep thanks are due to Pamela McClain, and to Ron McClain and John McClain, for the green light on this project, for compiling and supplying documentary materials, and for unflagging patience and support. Thanks also to Evelyn Henson for her work creating and maintaining the Ernest McClain website <https://ernestmcclain.net/>. And thanks to Gerry Turchetto for timely and crucial aid in proof reading.

## TABLE OF CONTENTS

<b>Jean Le Mee:</b> <i>THE CHALLENGE OF ABUL WAFA.</i>	p. 1
<b>Leon Crickmore:</b> <i>CASTLERIGG: STONE OR TONE CIRCLE?</i>	p. 9
<b>Jay Kappraff:</b> <i>ANCIENT HARMONIC LAW.</i>	p. 19
<b>Sarah Reichart &amp; Vivian Ramalingam:</b> <i>THREE HEPTAGONAL SACRED PLACES.</i>	p. 33
<b>Pétur Halldórsson:</b> <i>PATTERN OF SETTLEMENTS PACED FROM 1-9.</i>	p. 51
<b>Anne Bulckens:</b> <i>THE METONIC CYCLE OF THE PARTHENON.</i>	p. 61
<b>Jay Kappraff and Ernest McClain:</b> <i>THE PROPORTIONAL SYSTEM OF THE PARTHENON.</i>	p. 81
<b>Richard Heath:</b> <i>THE GEODETIC AND MUSICOLOGICAL SIGNIFICANCE OF THE SHORTER LENGTH OF THE PARTHENON.</i>	p. 97
<b>Richard Heath:</b> <i>ERNEST McCLAIN'S MUSICOLOGICAL INTERPRETATION OF ANCIENT TEXTS.</i>	p. 99
<b>John Bremer:</b> <i>THE OPENING OF PLATO'S POLITY.</i>	p. 123
<b>Bryan Carr:</b> <i>ONTOLOGY INSIDE-OUT.</i>	p. 139
<b>Babette Babich:</b> <i>THE HALLELUJAH EFFECT.</i>	p. 171
<b>Pete Dello:</b> <i>McCLAIN'S MATRICES.</i>	p. 201
<b>Richard Dumbrill:</b> <i>SEVEN? YES -- BUT ...</i>	p. 213
<b>Howard Barry Schatz:</b> <i>THROUGH THE EYES OF PLATO.</i>	p. 245
<b>Gerry Turchetto:</b> <i>MEMORIES OF ERNEST G. McCLAIN.</i>	p. 267



# THE PROPORTIONAL SYSTEM OF THE PARTHENON AND ITS CONNECTIONS WITH VEDIC INDIA

*Jay KAPPRAFF and Ernest G. McClain*

## Abstract

Anne Bulckens carried out research on the proportions of the Parthenon and discovered the module for the Parthenon and the smallest unit of measure called the Dactyl. As a result, and with the help of the ethnomusicologist, Ernest McClain, a strong case can be made that the lengths and widths of the inner temple, the cella, and the platform upon which the outer temple lies, the stylobate, and the temple height to the entablature correspond to relative frequencies of the ancient pentatonic musical scale. New work by the author shows that there may have been a connection between the proportions of the Parthenon and the dimensions of a Vedic ceremonial altar known as the Rathakatra Citi. We have also found evidence of Vedic measures of the length of the solar and lunar years in the proportions. Computation of the square root of two was a major theme in the Sulba Sutra, what may have been the first book of geometry associated with the Vedic world. Representations of  $\sqrt{2}$  figure greatly in the proportions of the Parthenon.

## 1. Introduction

This article will explore the possibility that there was a connection between the proportions of

the Parthenon built between 447 and 438 BCE and a Vedic ceremonial altar known as the Rathakakra Citi Chariot Wheel. The construction of Vedic Indian fire altars was described in the Sulba Sutra dating to between 600 and 800 BCE. Subhash Kak (1995, 2016) reports that ceremonial altars were also found in ancient Greece. As a result, two fundamental units are proposed that, when used, reveal measurements directly connected to the lengths of both the lunar and solar years. This work suggests a new approach to archaeology, namely, the careful study of mathematical proportions as a way to uncover aspects of a structure embedded ages ago in the architecture. We describe this as a kind of mathematical excavation. This article builds on previous articles of ours on the Parthenon which proposed that its structure was based on the Pythagorean and Just, pentatonic and heptatonic scales (Kappraff, 2002a, 2005).

## 2. The Parthenon

The Parthenon shown in figure 1 is a Doric temple with certain Ionic features. As in all Doric temples, the entablature, a platform above the columns, contains a line of triple-ridged triglyphs, a square stone block sitting atop the columns. These are surrounded by metopes, rectangular panels with carved sculptures by the great sculptor Phidias depicting scenes from Greek history and mythology. The outer temple sits on a platform called the stylobate, and encloses an inner temple called the cella, shown in figure 2. The cella includes two chambers separated by a wall. One chamber, known as the naos, housed a large statue of Athena: while the other chamber, the opisthodomos, served as the treasury of the Delian league. There was also a small shrine in the arcade between the cella and the columns to the South from Mycenaean times dedicated to Athena. This shrine was also present in two previous Parthenons circa 566 and 490 BCE each of which were destroyed by the Persians, archenemies of the Greeks. The purpose of the shrine was to show that the Greeks had always occupied the land.

The current Parthenon also has several unusual features. Instead of the normative six columns to the East and West it has eight, while it is unique

among temples in having 17 columns along the north and south flanks. In addition, the stylobate is slightly curved in the north-south and east-west directions, and the columns are not perpendicular but slightly protracted inwards. More than any other temple, the Parthenon appears to have been crafted to extraordinarily close tolerances, in some cases less than a millimeter. These design idiosyncracies appear to have roots in the proportional system of the structure.

All ancient temples were based on a measurement known as the temple 'foot'. Each temple also had a most commonly encountered measurement known as its Module. Anne Bulckens (1999, 2001) studied the measurements of William Cranmer Penrose carried out in 1885 and she hypothesized the length of the Parthenon foot, as well as a Module that renders all of the important dimensions within the Parthenon as whole numbers, and a fundamental unit called a Dactyl, approximately the length of a finger joint. These units served as a kind of Rosetta stone enabling an exploration of the possible meaning behind the proportions. Of course every measurement has some degree of error, but Bulckens required measurements to be equal or less than 0.2% off from the actual measurements. For this reason, some measurements were taken from the corner of the stylobate and others from the midpoint of the sides taking advantage of the small differences at these locations due to curvature. Moreover, lengths were measured from diverse locations along the base of the Parthenon and they were taken from the inside or outside of a wall; or they included or excluded the antae wall or a small plinth. Bulckens was careful to indicate precisely where measurements were taken and one might wonder if this prejudices her arrival at a particular set of integers. By contrast, however, Penrose had suggested a foot length, which is referred to as the 'Penrose foot', from which almost no integer can be derived no matter which reasonable definition is used.

Now that a set of whole numbers were obtained for Parthenon measurements, with the help of the ethnomusicologist, Ernest McClain (1976, 1978), we shall show these numbers

reproduced the tones of Pythagoras' musical scale, pentatonic, heptatonic, and Just.

The study of the Parthenon also suggests an infatuation with number with the recurrence of the numbers 4, 6, and 7 associated with Athena while 9 referred to Poseidon who had been Athena's competitor for the designation as patron of Athens. The integers 4, 6, and 9 are found in many places within the Parthenon. For example, there are 46 columns along the perimeter of the temple. Inside the cella there are two stories of 23 Doric columns equaling 46. There are 4 Corinthian columns within the opisthodomos and 6 Ionic columns at its west and east porches and 9 columns along the side of the naos plus the antae wall. There are 444 coffered panels and 9000 marble tiles, etc., etc.

On the other hand, the temple could be seen as evidence of the ability of its architects to compute rational approximations to the square root and cube root of two. The number 7 is of particular importance. Not being divisible by any number other than itself or 1 it may have been associated with Athena as virgin not born of woman but from the head of Zeus. The number 7 was incorporated into the Parthenon proportions as described in a previous paper (Kappraff and McClain, 2005).

### 3. The Units

In 1982, the archaeologist Ernst Berger did a computer study of the Parthenon which showed that the temple had a recurring Module measuring 858 mm, rounded to the nearest millimeter. This Module was the size of the triglyph. The first century architecture historian Vitruvius also listed the length of a triglyph as the Module used for the construction of Greek temples and specified that the length of the metope should be in a ratio of 3:2 with the triglyph. Bulckens hypothesized that the Module should measure  $2\frac{1}{2}$  Parthenon feet, with the Module constituting a typical 'pace' of  $2\frac{1}{2}$  feet, making the Parthenon foot 343 mm and her Parthenon Module 857.5 mm. That  $343=7\times7\times7$  may be more than coincidental will be discussed in a forthcoming paper by Bulckens.

As in other Greek temples the 'foot' is divided into sixteen parts with each part called a dactyl D, or finger. This meant that the triglyph would

measure 40 D while the metope would measure 60 D consistent with Vitruvius. The width of the stylobate is 36 Modules or 1440 D.

4. The Ancient Musical Scale of Pythagoras

The principal claim of this and previous articles suggests that the most prominent dimensions of the Parthenon are based on the pentatonic and, to a smaller extent, the heptatonic musical scales. We give a quick review of the nature of the Pythagorean musical scale and leave the reader to find more details in the references (Kappraff, 2002b, 2010, 2013). The relative frequency of the tones of the musical scale have been reduced to whole numbers in the sense expressed by Plato in the *Republic*:

For surely you know the way of men who are clever in these things. If in the argument someone attempts to cut the one itself (i.e., use a fraction), they laugh and won't permit it. If you try to break it up into small coin, they multiply...

*Republic* 524

The 12 tones of the equal tempered scale are shown on the tone circle in figure 3. Each of the twelve tones is referred to as a semitone. The tones are labeled by the letters A,B,C,D,E,F,G,A,... augmented by sharps and diminished by flats with frequencies of the tones increasing in a clockwise direction and doubling after one cycle. The tone at 12 o'clock is called the fundamental and assigned the relative frequency 1. D has been taken to be the fundamental and we will see that this results in the ancient Phrygian mode of the heptatonic scale. This was the preferred mode of Plato. Once around the tone circle is called an octave and assigned the relative frequency 2. After one cycle (octave), it is the miracle of music that tones sound identical to the ear so that each tone on the tone circle represents a pitch class of tones all having a ratio of frequencies a power of 2. On the equal tempered scale, where the tones are evenly spaced around the circle, the frequencies increase by approximately 6 % per semitone, doubling at the octave limit in a way similar to compound interest. The ancient Pythagorean scale approximates the values on the equal tempered scale using tones

expressed as the ratio of integers.

In figure 4 the fundamental is represented by a length of string. If the bridge is placed at the midpoint of the string, the tone of the bowed string has a pitch an octave above the fundamental. Note that relative frequency is the inverse of relative string length. If the bridge is placed at the 1/3 position of the string and the remaining 2/3 of the string is bowed the result is the fifth. When 3/4 of the string is bowed the result is a fourth. So we see here the primacy of the numbers 1, 2, 3, 4 which were immortalized by the Greek tetractys of ten markers shown in the detail from Raphael's School of Athens in figure 5. The ratio 2:1 is the octave or diapason, 3:2 the fifth or diapente, while 4:3 is the fourth or diatesseron, and 3:1 a fifth above an octave. In this paper I will express tones in terms of relative frequency.

Consider the Nicomachus Table 1 below. He was a Syrian mathematician who lived in 150AD and was one of the last mathematicians to have direct knowledge of the musical system expressed in the works of Plato and Pythagoras.

1	2	4G	8	16C	32	64	...
	3	6D	12	24G	48	96	...
		9A	18	36D	72	144	...
			27	54A	108	216	...
				81E	162	324	...
					243	486	...
						729	

Table 1. Nicomachus' table for expansions of the ratio 3:2 (as relative frequencies)

Observe that the integers in each column form a geometric sequence the common ratio of which is 3:2, the relative frequency of successive musical fifths announced in column 3. For example the third column is 4,6,9 labeled G, D, A, i.e.,

G	D	A
4	6	9

The interval from G to D is a rising musical fifth (five tones: GABCD) while the interval from D to A is also a rising fifth (DEFGA). The ratio of 3:2 can alternatively represent string length in which case G and A would be inverted and we would have A,D,G. Mid-tone of this sequence D

is taken to be the fundamental and the other tones are placed in a single octave as follows: The largest value of the relative frequency is chosen in this case to be 9. The fundamental is then multiplied by powers of 2 to create a single octave enclosing 9, i.e., D is taken to be the 6/12 octave. The other tones are multiplied by a power of 2 to place them in the 6/12 octave, i.e., 4 is multiplied by 2 and this results in the following sequence:

D	G	A	D
6	8	9	12

This tetrachord can be found in the works of Plato (McClain, 1978). This tetrachord is also found in the arrangement of the statue of Athena and the ancient shrine. The distance from the edge of the Stylobate to the inside of the wall between the Naos and the Opisthodomos is 2000 D, the distance to the statue of Athena is 1500 D, and to the shrine is 1333.333... D or 1000:1333.333:1500:2000 = 6:8:9:12.

Figure 6 shows these three tones on the tone circle. If D is placed atop the tone circle, then the rising fifth at A, where a fifth amounts to seven semitones, and the falling fifth at G occur at 7 o'clock and 5 o'clock respectively on the tone circle. G can also be referred to as a rising fourth (DEFG).

Alternatively, 1 is reserved for the relative frequency of the fundamental. The number 2, the first female number according to Platonic mythology, results in the octave. The number 3, the first male number, is required to generate the other tones of the scale. For example, 3 is in the same pitch class as 3/2, the relative frequency of the rising fifth, whereas, 1/3 is in the pitch class of 2/3 a falling fifth. Therefore:

G	D	A
1/3	1	3
1	3	9
8	6/12	9

where we have multiplied the relative frequencies by 3 to remove fractions, then multiplied by powers of 2 to place the tetrachord in a single octave. When placed in scale order, this results again in the

tetrachord:

6	8	9	12
D	G	A	D

Since the semitones are all the same size for the equal tempered scale, the tritone, the most dissonant interval, is located at 6 o'clock and has a relative frequency equal to  $\sqrt{2}$  when the fundamental has the value 1. The tritone is located in the space between the rising and falling fifth at 9 and 8 respectively, and so it may be approximated by the average of 8 and 9. However, to avoid fractions, the tetrachord was doubled to: 12 16 18 24 where the average of 16 and 18 is 17, so that the square root of 2 can be approximated by:  $\sqrt{2} \approx 17/12$ . It was McClain's conjecture that 17 relates to the number of columns along the flank. We shall give more supporting evidence in Section 8. The Just scale was based on the ratio of integers factorable by primes 2,3 and 5.

For the integers in the fifth column, i.e.,

C	G	D	A	E
16	24	36	54	81

the tones represent five successive perfect fifths with the central tone D as the fundamental. Since the largest relative frequency is 81 it must be sealed in the 72/144 octave with the other tones multiplied by powers of 2 to place them in the 72/144 octave:

D	E	G	A	C	D
72	81	96	108	128	144

This is the pentatonic scale with fundamental D and shown in figure 7a on the tone circle. It is derived by counting 7 semitones twice in a clockwise (rising) direction and twice in a counterclockwise (falling) direction. Again we can generate the pentatonic scale using only the number 3 as we did for the tetrachord,

C	G	D	A	E
1/3 <sup>2</sup>	1/3	1	3	3 <sup>2</sup>
1	3	9	27	81
128	96	72	108	144

Placing the tones in scale order results again in the pentatonic scale as shown above.

E	D	C	B	A	G	F	E	D
384	432	486	512	576	648	729	768	864

The heptatonic scale is also derived by counting 7 semitones three times in a rising and falling direction. From D to D is the 432/864 octave shown on the tone circle in Fig. 7b. With an additional tone E, this is the tuning of the nine string lyre used during the time of Plato. The ratio between the frequencies of the tones at the beginning and end of these nine tones is 9:4, the most prominent proportion within the Parthenon.

### 5. The Pentatonic Scale in the Parthenon

Up to the time of this study, the proportions known for the Parthenon were the ratio of width to the height of the temple from the stylobate to the top of the entablature shown in figure 2 and the ratio of length to width of both stylobate and cella are 9:4. Bulckens has determined that the tones of the pentatonic scale: 16, 24, 36, 54, 81 relate to measurements within the Parthenon in terms of Module (M) as follows:

Height of the Parthenon from the stylobate to the top of the entablature = 16 M = 640 D  
 Width of the Cella = 24 M = 960 D  
 Width of the Stylobate = 36 M = 1440 D  
 Length of the Naos = 36 M = 1440 D  
 Length of the Cella = 54 M = 2160 D  
 Length of the Stylobate = 81 M = 3240 D  
 where,  $36 : 16 = 81 : 36 = 54 : 24 = 9 : 4$ .

The 960 D width runs through the cella walls and is shown in figure 8a. It is the 5 interaxials of the perimeter columns that stand in front of the cella minus one radius of the perimeter columns. (In many temples of Greek antiquity there was a relation between the cella walls and the perimeter columns.)

Bulckens observed that the length of the naos fits as a missing 6 between the length and width of the cella:

$$54:36::36:24 = 9:6::6:4$$

It follows that  $9 \times 4 = 6 \times 6$  so that a square with the side equal to the length of the Naos has the same area as the rectangular area of the cella as

shown in figure 8b. Furthermore the ratio of 3:2 enters in another way, width of stylobate: width of cella = length of stylobate: length of cella = 3:2

### 6. Pythagorean Triples in the Parthenon

Many Pythagorean triples were found on a cuneiform table, Plimpton 322, dating to about 1000 BCE. Three of these triples are to be found in the Parthenon:

a. 3,4,5-triangle  
 Area = 6  
 Perimeter = 12  
 Radius of the inscribed circle = 1

b. 5,12,13-triangle  
 Area = 30  
 Perimeter = 30  
 Radius of the inscribed triangle = 2

c. 8,15,17-triangle  
 Area = 60  
 Perimeter = 40  
 Radius of the inscribed circle = 3

We will see the first triple emerge in the proportions of the stylobate where the stylobate will be shown in Sec. 8.1 to be tiled by six 3,4,5-right triangles. The second triple will encompass the cella, and the third will relate directly to the connection between the Parthenon and a Vedic ceremonial altar described in the next section.

### 7. The Vedic Indian Fire Altars

The Sulba Sutras are part of the Vedic literature. They are Sanskrit texts written by the Vedic Hindu scholars before 600 BCE, but are thought to be compilations of oral wisdom which may go back to 2000 BC. They form part of the Kalpa Sutras which in turn are a part of the Vendantas. The meaning of sulba is 'string, cord, or rope'. The general format of the main Sulba Sutras are the same; each starts with sections of geometrical and arithmetical constructions and ends with details on how to build Citis which are ceremonial platforms or altars (Joseph, 1996; Kak, 1999). The measurements are performed by drawing arcs with different radii and centers using a cord or sulba. Following is John Price's description (Price, 2000):

‘Each of the Citis is a low platform consisting of layers of carefully shaped and arranged bricks. Some are quite simple shapes such as a square or rhombus while others are much more involved, such as a falcon in flight with curved wings, a chariot wheel with spokes, or a tortoise with extended head and legs. These latter designs are particularly beautiful and elegant depictions of powerful and archetypal symbols, the falcon as the great bird that can soar to heaven, the wheel as the ‘wheel of life’.

The Sulba Sutra may be the first recorded geometry book. I will state several of the geometrical constructions found in this book.

1. Given a rectangle, construct a square with the same area.
2. Given a two squares, construct a square that has area equal to the sum or difference of the two.
3. Given a circle, construct a square with the same area.
4. Construct a ratio of integers that approximates  $\sqrt{2}$ .

We have seen evidence of the first of these constructions in the Parthenon as shown in figure 8b. The second construction anticipates the Pythagorean theorem by more than one hundred years. The third cannot be carried out with compass and straightedge construction, however the Vedic mathematicians succeeded within 1.6%. To carry out the third construction, an accurate ratio was needed and the altar builders came up with an elaborate construction of the ratio,  $577/408$  which is in five decimal place agreement with  $\sqrt{2}$  (Henderson, 2000). Information about the Pell’s series and its application to expressing  $\sqrt{2}$  may have been known to Vedic mathematicians.

The Pell’s series are sequences of integers with the property:

$$a_n = 2a_{n-1} + a_{n-2}$$

Pell’s sequences beginning with 1 2 and 1 3 yield,

	1	3	7	17	41	99	239	577
	1	2	5	12	29	70	229	408
n	1	2		4				8

We have found that the ratio of values are

approximations to  $\sqrt{2}$  for the values of n from the geometric series 1,2,4,8 to be the values most used in the Parthenon.

The Rathacakra Citi has the shape of a chariot wheel. Its construction was described in BSS III, 187-214 (i.e., Baudhayana Sulba Sutras). It requires seven types of bricks for the odd layers and nine types for the even layers. In the actual Citi, the bricks, although having different shapes, have all the same area. There seems to be some flexibility about the final design with one schematic shown in figure 9. This schematic illustrates the overall configuration although the accounting for the bricks does not completely correspond to the schematic. The actual Citi consists of a rim and a center connected by sixteen spokes. The space between the spokes is congruent in area to the spokes. It is recorded that the rim is made up of 145 bricks that have been properly subdivided. The spokes total 64 bricks in area and the center has an area of 16 bricks, leaving an area of 64 bricks for the spaces between the spokes. Therefore, the total built area of the Citi is,

$$145 + 64 + 16 = 225 \text{ bricks}$$

and the total wheel in which the spaces are filled in measures,

$$225 + 64 = 289 \quad \text{or} \quad 289 - 64 = 225$$

which can be rewritten as the Pythagorean triple,

$$17^2 - 8^2 = 15^2$$

This Pythagorean triple is found in the table of triples recorded on the cuneiform tablet Plimpton 322. The perimeter = 40, the area = 60, and the radius of the inscribed circle = 3 all numbers of significance for the Parthenon. The Module has length 40 D while the metope has length 60 D and, as we have seen, the musical scale of Pythagoras can be constructed, as we have shown, from the number 3. We suggest that this triple echoes the 17 columns to the North-South and the 8 columns to the East-West of the Parthenon. We will now make a case for 225 relating to the area of the stylobate.

Consider the area of the stylobate,  $3240 \times 1440$  square D, and divide it by 225 bricks to obtain the area of a brick:

$$\frac{3240 \times 1440}{225} = 144^2$$

If the bricks are assumed to be square, the side

of a brick is 144 units.

Next we remove the rim from the chariot wheel and compute the filled in interior to be 144 units so that,

$$144 + 145 = 289 \quad \text{or} \quad 144 + 144 + 1 = 289$$

As a result we have,

$$12^2 + 12^2 + 1 = 17^2$$

from which it follows that  $17/12 \approx \sqrt{2}$  where the error is related to the left over 1. The square root of 2 was a key proportion in the Parthenon.

The geometry of the Rathacakra Citi used all of the Sulba Sutra constructions listed above. A square could be constructed with the same area as the chariot wheel. The area of the wheel itself, 225 Bricks, can be constructed as the difference between two squares, 289 and 64 square units. The basis of the square root of 2 calculation lies in the construction of a square, 289, equal to a double square rectangle, 144 + 144 with 1 unit error.

If we are to make a connection between the Rathacakra Citi and the Parthenon, then the unit of a Brick length  $B = 144D$ , is clearly important. Another length of 120 D arises from the Vedic India connection. The unit of a Purusha was used to construct the altars with 120 Angulas = 1 Purusha. The Purusha is exactly the length of a six foot man with his hand raised to 7.5 feet. Therefore, 1 Angula = 0.75 in. Compare this with the length of a dactyl where 1 D = 0.8439 in. or 1 angula = 0.888...D. So we see that the angula is comparable to the dactyl measurement. The unit of 120 D, which we shall refer to as a Parthenon Purusha or PP is a second unit inspired by Vedic sources where 8 dactyls = 9 Angulas or 8 PP = 9 Purushas.

The altar was created to have an area of exactly 7.5 square Purushas where,

$$7.5 \times 120 \times 120 = 108,000 \text{ square Angulas.}$$

The number 108,000 was important in Vedic culture representing the number of verses in the Bhagavad Gita. We will find that in the dimensions of the Parthenon and in Vedic lore variations on this number such as 108, 1080, 10800, 18 appear. For example, it was recognized by Vedic astronomers that there are very close to 108 lunar diameters reaching from the Earth to the Moon and 108 solar diameters reaching from the Earth

to the Sun.

So we have derived two new units,

$$1 \text{ Brick} = 144 D \quad \text{and} \quad 1 \text{ PP} = 120 D$$

It should be noted that the integers 144 and 120 have an important musical meaning. McClain and Levarie (1994) have shown that the ancient Dorian heptatonic scale can be represented with smallest integers in a rising double octave, 36:72::72:144 and a falling double octave, 120:60::60:30 in which 144 and 120 provide the upper limits.

Bulckens observed that a day has 1440 minutes. She divided the day into 14400 = 120 x 120 parts with each part a duration of 6 seconds. In this way she is able to express an area of 120 D x 120 D as equivalent to one day so that area could be correlated with time. If I would do the same for the Vedic altar, for example, the area of the altar, 7.5 square Purushas x 120 D x 120 D is equivalent to 7.5 days.

## 8. Reflection on the Proportions of the Parthenon Through the Lens of Various Units

We shall now look at the proportions of the stylobate and cella through the lens of a unit of 1D, 40D (the Module), 360 D (the radius of the inscribed circle of the 3,4,5-triangles tiling the stylobate), the spacing of 200 D between the columns, 120 D (the Parthenon Purusha (PP)) and 144 D units (the Brick). Each unit will illustrate different aspects of the proportional system.

### 8.1 1 unit = 1 D and 1 Module = 40 D:

A schematic of the stylobate and the cella is shown in figure 10. Notice that the stylobate divides evenly into six 3, 4, 5 - triangles the areas of which are 777,600 again celebrating Athena while the radius of the inscribed circle is 360 D. The areas of the opisthodomos and the naos are 432 and 846 respectively, the octave limits of the heptatonic scale in the Phrygian mode. Since the dimensions of the Parthenon (McClain and Levarie) have been shown to relate to the musical scale, it is reasonable to imagine that the lengths might represent a class of integers differing by multiples of 2 so that 2160 could be interpreted as 1080 another instance of the Vedic number. Also the perimeters of the 3, 4, 5 - right triangles are 4320 D = 4 x 1080, the Vedic

number again making its appearance.

### 8.2 1 unit = 360 D:

This system (see Fig. 11) illustrates the 9:4 ratio of the stylobate and cella and also shows directly that the stylobate can be subdivided into six 3,4,5-right triangles. In Vedic India, 360 tithis was taken to be the length of the lunar year while in ancient Greece 360 days was the length of the canonical year, a compromise between solar and lunar years. We also see the areas of the cella and stylobate recapitulating the width of the stylobate and the height to the entablature, 36 and 16.

### 8.3 1 unit = 200D:

In the first planning stage of the Parthenon, the distance between the columns measured center line to center line was 200D. Later there were small variations on these measurements (Bulckens, 1999). In figure 12 you will notice that along the width of the cella there are six columns and five 200 D intervals between the columns on the East and West while along the length to the North and south there are 12 columns. As a result a 5,12,13 right triangle can be inscribed in the cella. This triangle has a perimeter of 6000D and a radius of the inscribed circle equal to 400D again illustrating Athena's numbers.

### 8.4 1 unit = 120 D:

In this system (see Fig. 13) it is clear that the inner spaces all have ratios of either 4:3 or 3:2, perfect fourth and fifth. Also the ratio of length of naos: length of opisthodomos = 2:1 while length of cella: length of opisthodomos = 3:1, all ratios of numbers from the tetractys. It should be noted that by the length of the cella we mean the length of the naos and opisthodomos combined. In figure 13 the lengths of the naos, opisthodomos, width of the cella, and 1/3 of the stylobate reproduce the tetrachord: 6 8 9 12. It is also clear now that six 3, 4, 5 - right triangles can also be inscribed in the cella. The stylobate has the proportions, 27:12 which suggests the Vedic computation of the solar year in terms of 12 months of 27 nakshatras per month of 324 tithis, where a tithis can be taken to be a Vedic day, slightly longer than our usual day,

and where the area is expressed as units of time, according to Bulckens.

To this is added a correction factor of 48 Tithis equal to the area of the opisthodomos to get,

$$324 + 48 = 372 \text{ Tithis.}$$

This is the first approximation to the solar year in the Vedic system where 360 tithis was taken as the length of the lunar year. The fire altar builders established an elaborate procedure in which 95 levels were added to the altar to correct this value to close to the actual length of the solar year to  $372 - 90/95 = 371.05\dots$  Tithis which turns out to be within 0.1% of the value that we accept in terms of days (Joseph, 1996; Kak, 2005).

In figure 14 we see the stylobate divided into nine similar rectangles each with the same proportion as the whole with length 1080 D and width 480 D. The ratio,

$$\text{length: width} = 1080:480 = 9:4$$

This makes the area,  $A = 10,800 \times 48$  which corresponds to the 10,800 muhartas that sum to the number of minutes in a lunar year where one muharta equals 48 minutes. Dividing by 1440, the number of minutes in a day,

$$10800 \times 48 / 1440 = 360$$

which is the number of Vedic days or Tithis, in a lunar year.

We have now seen that both lunar and solar astronomy have been built into the Parthenon proportions. Anne Bulckens will provide in her article, *The Metonic Cycle of the Parthenon* in this edition, a more detailed analysis of the areas within the Parthenon directly correlated with the length of the solar and lunar years.

### 8.5 144 D = 1 Brick (B):

In this system (see Fig. 15) the width of the stylobate is 10 bricks while the area of the cella is 100 square bricks, and the length of the cella is 15 bricks while the area of the stylobate is 225 square bricks. The length of the stylobate is divided into thirds of 7.5 B, a number that duplicates the area of the fire altar.



### 9. From Rathacakra Citi to the Parthenon

In Section 7, we listed four geometric constructions carried out in Vedic times according to the Sulba Sutra. I would now like to show how, through several steps, these constructions enable the Rathacakra Citi ceremonial altar to be reorganized into the dimensions of the Parthenon.

1. The Rathacakra Citi has an area of 289 square units including the empty spokes which account for 64 square units. Construct a square with the same area as the Citi, i.e., a 17 x 17 square units as shown in figure 16 (step 3 from Sec. 7) .

2. Consider the 8, 15, 17 Pythagorean triple with a 17 x 17 square on the hypotenuse and a 15 x 15 square on a side as shown in figure 17 (step 2).

3. Construct a 22.5 x 10 rectangle with the same area as the 15 x 15 square, i.e., 225 square units as shown in Fig. 18 (see step 1). Note that:

$$10 : 15 :: 15 : 22.5$$

which replicates the principal Parthenon proportion:

$$4:6::6:9$$

4. Taking the 144 D length and width of the brick as the unit, the 10 x 22.5 rectangle now measures:

$$1440 \text{ D} \times 3240,$$

the length and width of the stylobate.

5. The Rathacakra Citi also presents a geometric construction of  $\sqrt{2}$  according to Section 7 as shown in figure 19 (see step 4 and Pells sequence).

### 10. Conclusion

This analysis has shown that the Parthenon represents an excellent expression of the Greek Quadrivium which states:

Athenian youth should keep their eyes on  
Unity and study: music, astronomy, geometry,  
and number. *Epinomis*

As a result of the accuracy of Bulckens' measurements and choice of the basic unit of a Module, Parthenon foot and Dactyl, I am confident that the proportions of the Parthenon were organized by the pentatonic and heptatonic scales of Pythagoras. The close fit between the Rathacakra Citi Chariot Wheel and the Parthenon

reveal two natural units with which to measure the Parthenon, 144 D and 120 D. These units reveal in the proportions an expression of the lengths of the solar and lunar years to great accuracy pushing back the date of these discoveries.

Finally, I would like to convey to the reader my surprise as I, time and again, asked a question of the proportions and they responded with values significant to the analysis. For example how nice to have the radius of the inscribed circles within the 3, 4, 5 - triangles in the stylobate measure 360 D corresponding to the Vedic lunar or canonical Greek year. Or by dividing the area of the stylobate into 225 bricks we find the side of the Brick to be exactly 144 D. Or how often the sacred Vedic number 108,000 appears along with its variants.. Or that 120 D is a unit that reveals both solar and lunar years in the proportions. This suggests the possibility that the architects of the Parthenon may have had access to earlier mathematical and astronomical concepts from Vedic India.

### Dedication

This article is dedicated to the memory of Ernest McClain who passed away in June 2014. For fifty years McClain was relentless in the pursuit of his vision of the treasures available in the ancient wisdom found in the sacred and philosophical works of all cultures still accessible if pursued in the proper way using music as the *lingua franca*.

### Acknowledgements

This article is reprinted from: Kappraff, J., The Proportional system of the Parthenon, Symmetry Art and Culture, ed. Gyorgy Darvas, Vol. 26, No. 4 (2016).

I acknowledge the painstaking research of Anne Bulckens in making the relationships in this paper transparent, and I also acknowledge the help of Arlene Kappraff in reading the paper and making helpful comments.

## References

- Bulckens, A.**, (1999). *The Parthenon's Main Design: Its Proportion and Meaning*. Ph.D. Thesis from Deakin School of Architecture. Geelong, Australia.
- Bulkens, A.**, (2001) The Parthenon's Symmetry. In *Symmetry Art and Science*, No. 1,2 38-41.
- Kappraff, J.**, and **McClain, E.G.**, (2005) The System of Proportions of the Parthenon: A work of musically inspired architecture. *Music in Art* XXX/1,2
- Kak, S.**, (1995 ) The Astronomy of te Age of Geometric Altars. *Q.J.R. astr. Soc.* Vol 36, 385-395.
- Kak, S.**, (2016) 9 Private communication.
- Kappraff, J.**, (2000) The Arithmetic of Nicomachus of Gerasa and its Applications to Systems of Proportion. *Nexus Network Journal* (www.nexus journal.com) Vol. 4, No. 3
- Kappraff, J.**, (2002a), 'The System of Proportions of the Parthenon and its Meaning.' *Proceedings of the 5<sup>th</sup> Bridges Conference*, ed. by R. Sarhangi
- Kappraff, J.**, (2002b) Beyond Measure: A guided tour through Nature, Myth, and Number. Singapore: *World Scinetific*
- Kappraff, J.**, (2013) Ancient Musical Law as a Generator of Cultural Metaphors. *Symmetry: Culture and Science*, ed. Gyorgy Darvas. Vol. 24, No. 1-4, 391-417; **McClain, E.G.**, (1974, 1984).
- Henderson, D.**, (2000). Square Root in the Sulba Sutra. In *Geometry at Work*, ed. C. Gorini. Math. Assoc. Of Am.
- Joseph, G.G.**, (1996). Geometry of Vedic Altars, in *Nexus: Architecture and Mathematics*, ed. K. Williams, Fuccechio: Edizioni Dell Erba.
- McClain, E.G.**, (1978, 1984) *The Pythagorean Plato* York Beach, ME Nicilas-Hays.
- McClain, E.G.**, (1976) *The Myth of Invariance*. York Beach, ME: Nicolas-Hays.
- McClain, E.G.**, and **Levarie, S.**, (1994) S. Temple Tuning systems. *International Jour. Of Musicology*, vol 3, pp 23-30.
- Price, J.F.**, (2000). Applied Geometry of the Sulba Sutra. In *Geometry at Work*, ed. C. Gorini. *Math. Assoc. of Am.*

## Figure Captions

1. The Parthenon
2. The façade and cella of the Parthenon
3. The equal tempered scale: the tone circle as a single-wheeled m chariot of the Sun
4. A sliding bridge on a monochord divides the 4 string length representing tones intervals into segments corresponding to musical fifth (2:3); fourth (3:4), and octave (1:2).
5. Left: Detail from the school of Athens by Raphael, right: Pythagorean musical scale and tetractys. Detail from the painting hosted at the Vatican
6. Rising and falling fifths. D, A, G are geometric, arithmetic and harmonic means in the octave.
7. The pentatonic and heptatonic scales.
8. a) The proportions of the cella ; b) showing the 4 naos as a square equal to the area of the cella. 9:6::6:4..
9. The Rathacakra citi chariot wheels.
10. Unit = 1 D and 1 Modules (M).
11. Unit = 360 D
12. The 5, 12, 13 right triangle in the cella.
13. Unit = 120 D 27 Naksatras x 12 months = 324 tithis. Correction factor = 48 tithis, solar hear (approximation) = 372 tithis.
14. The stylobate divided into nine similar rectangles illustrating the lunar year as 10,800 muhartas where each muharta equals 48 minutes..
15. Unit = 144 D = 1 Brick (B).
16. Squaring the circle in terms of area for the Rathacakra Citi
17. The 8,15,17 Pythagorean triple
18. A 225 square unit rectangle with the same area as a 15 x 15 square.
19. A sequence of diagrams illustrating the approximation, 17/12, derived from the Rathacakra Citi altar.



Figure 1. The Parthenon.

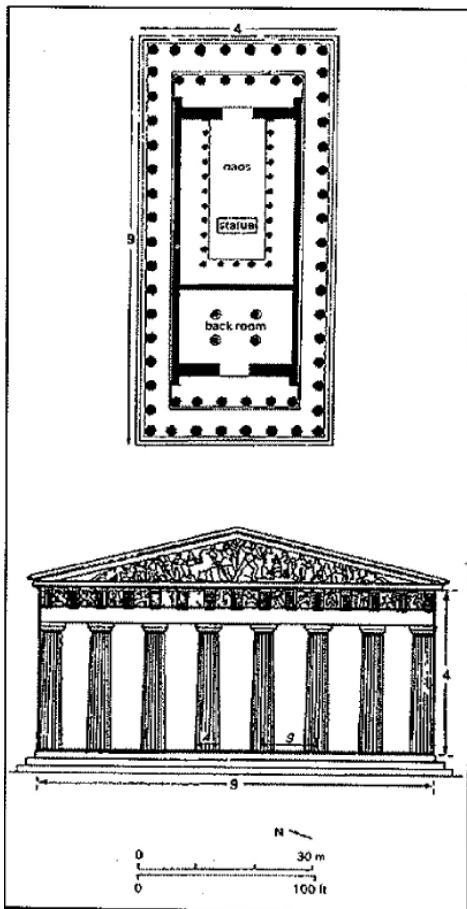

Figure 2. The façade and cella of the Parthenon.

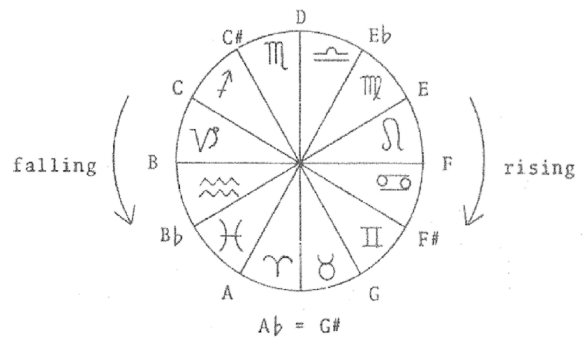

Figure 3. The equal tempered scale: the tone circle as a single-wheeled m chariot of the Sun.

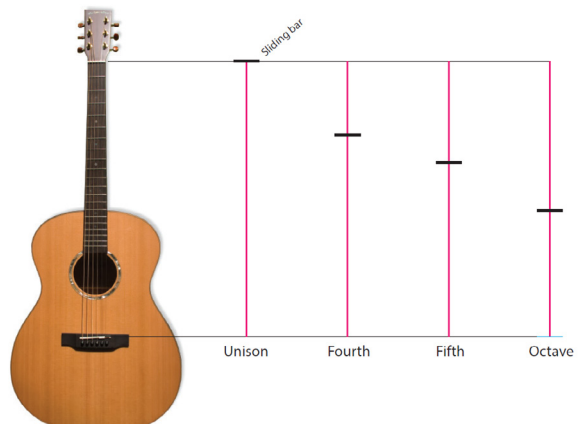

Figure 4. A sliding bridge on a monochord divides the string length representing tones intervals into segments corresponding to musical fifth (2:3); fourth (3:4), and octave (1:2).

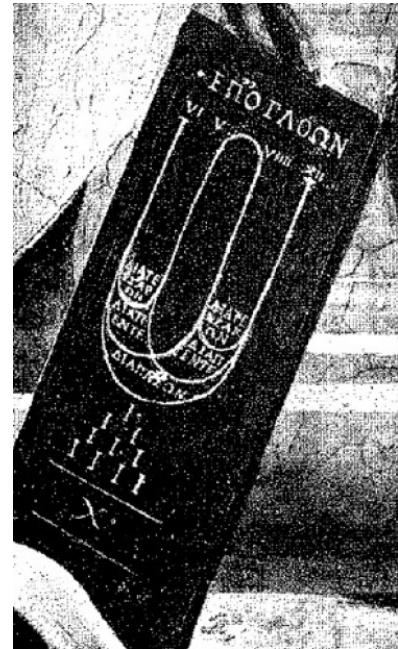
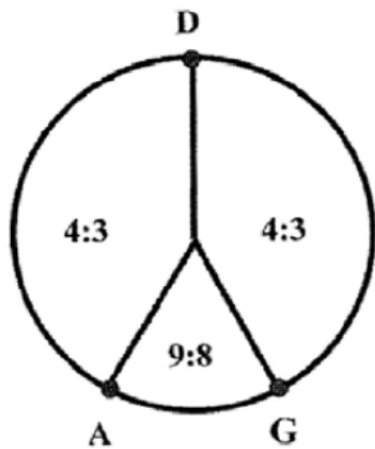

Figure 5. Left: Detail from the school of Athens by Raphael, right: Pythagorean musical scale and tetractys. Detail from the painting hosted at the Vatican.



<b>A</b>	<b>D</b>	<b>G</b>
<b>G</b>	<b>D</b>	<b>A</b>
<b>3<sup>1</sup></b>	<b>1</b>	<b>3</b>
<b>1</b>	<b>3</b>	<b>9</b>
<b>8</b>	<b>12/6</b>	<b>9</b>

<b>D</b>	<b>G</b>	<b>A</b>	<b>D</b>
<b>6</b>	<b>8</b>	<b>9</b>	<b>12</b>

**Invariant tones in Key of D**

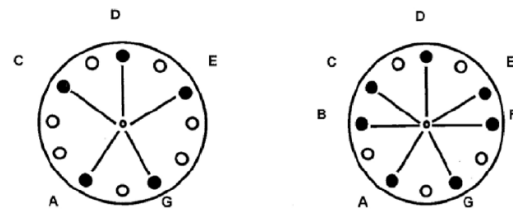

Figure 7. The pentatonic and heptatonic scales.

Figure 6. Rising and falling fifths. D, A, G are geometric, arithmetic and harmonic means in the octave.

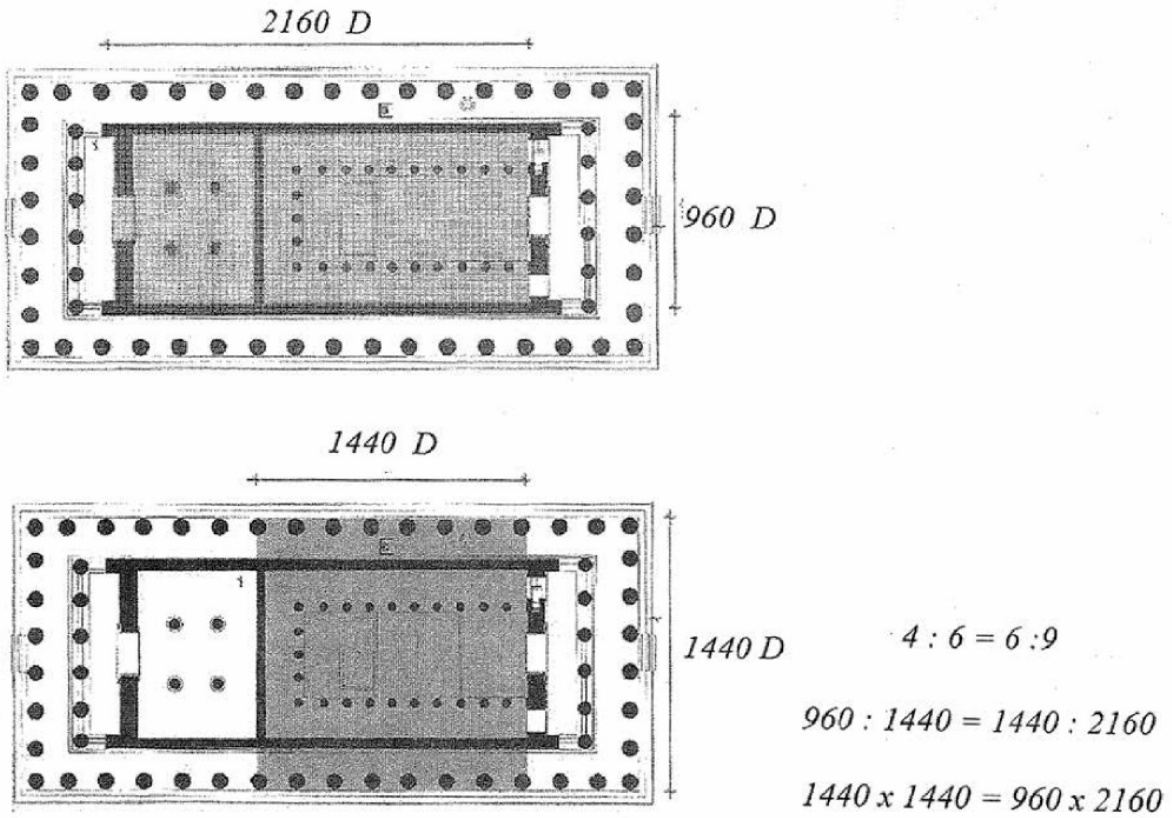

Figure 8. A) The proportions of the cella; b) showing the 4 naos as a square equal to the area of the cella. 9:6::6:4.

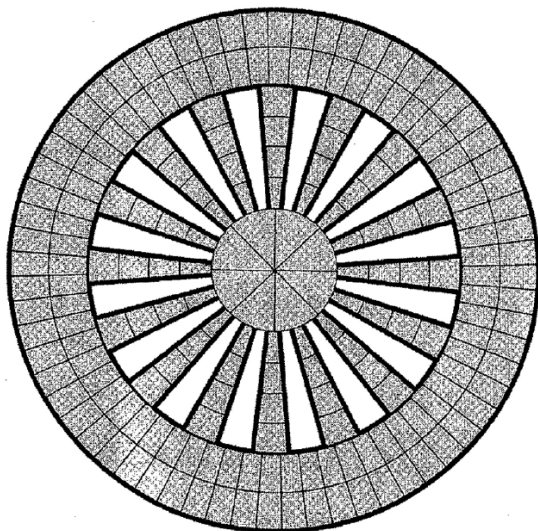

Figure 9. The Rathacakra citi chariot wheels.

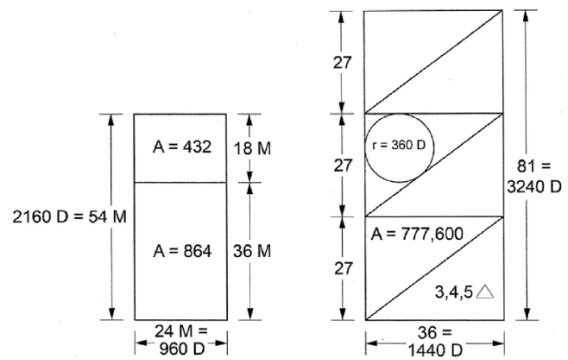

Figure 10. Unit = 1 D and 1 Modules (M).

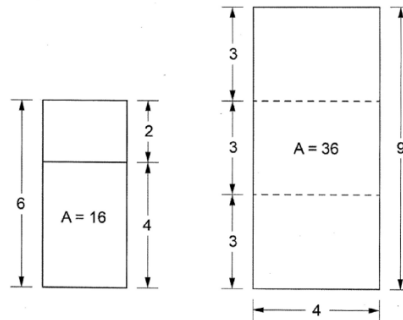

Figure 11. Unit = 360 D.

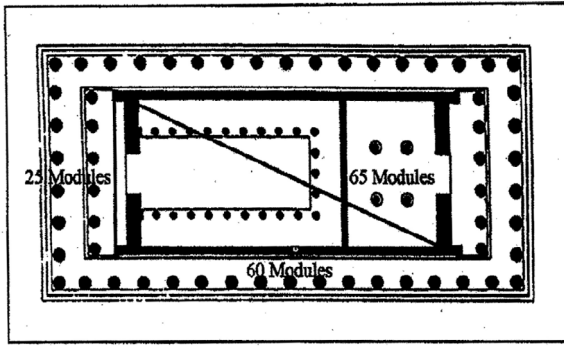

Figure 12. 5, 12, 13, right triangle in the cella.

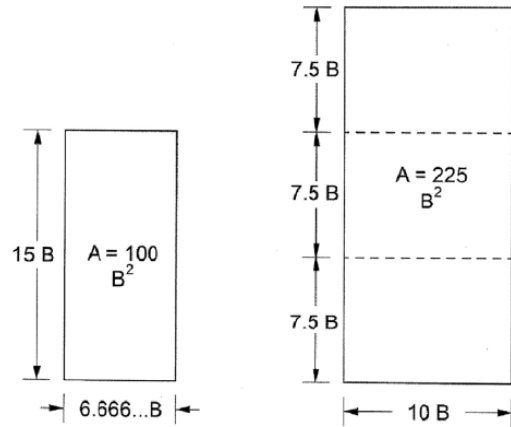

Figure 15. Unit = 144 D = 1 Brick (B).

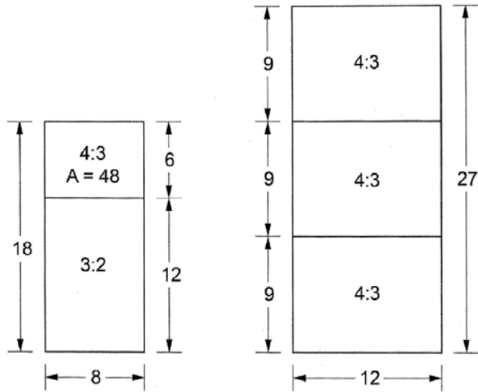

Figure 13. Unit = 120 D 27 Nakstras x 12 months = 324 Tithis. Correction factor = 48 Tithis, solar hear (approximation) = 372 Tithis.

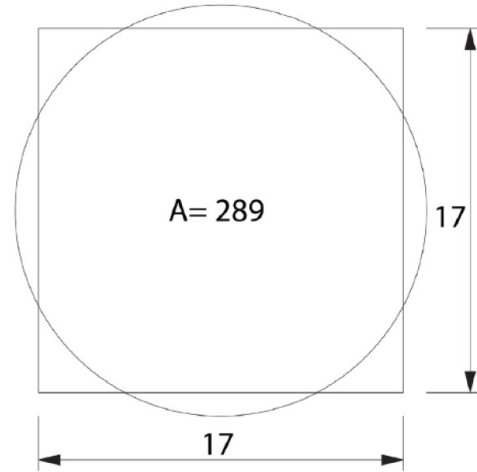

Figure 16. Squaring the circle in terms of area for the Rathacakra Citi.

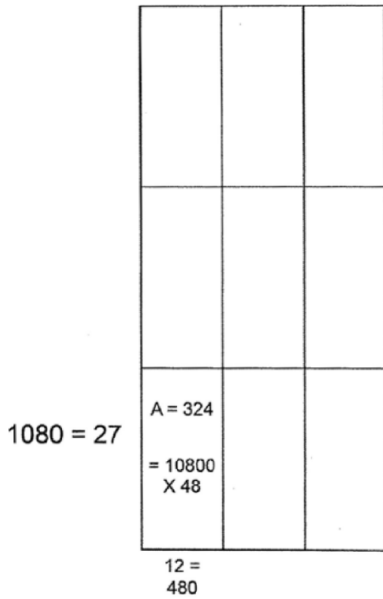

Figure 14. The stylobate divided into nine similar rectangles illustrating the lunar year as 10,800 muhartas where each muhart equals 48 minutes.

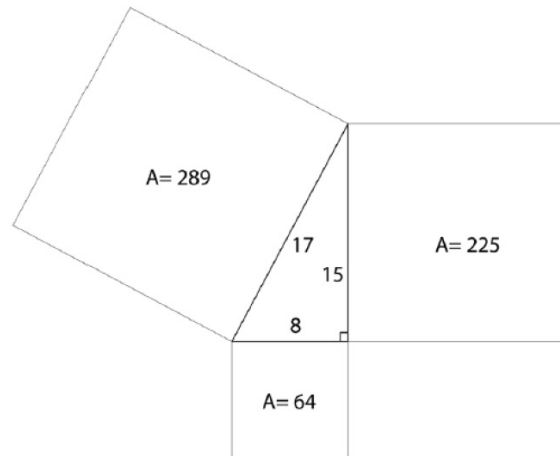

Figure 17. The 8,15,17 Pythagorean triple.

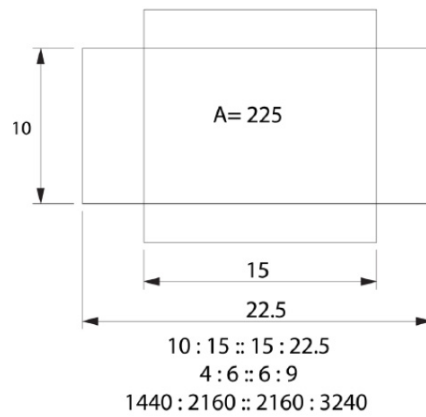

Figure 18. A 225 square unit rectangle with the same area as a 15 x 15 square.

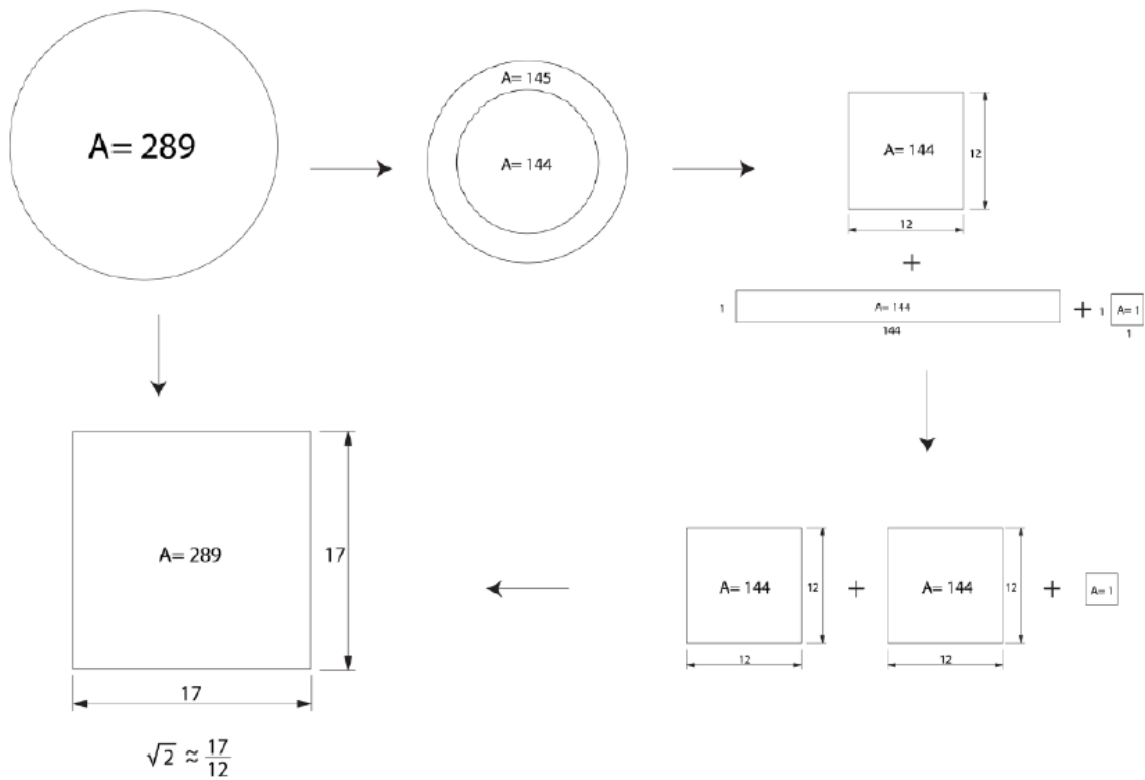

Figure 19. A sequence of diagrams illustrating the approximation, 17/12, derived from the Rathacakra Citi altar.